

1. Install the Radio Dock Adapter for Your Radio

- Select the Dock Adapter for your Radio by referring to "What's in the Box?" on the opposite side to identify the adapter, or turn the adapters over and locate the name imprinted on the underside of the adapter:

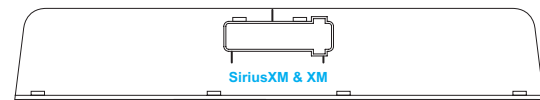

Sirius: Adapter 1 for all Sirius Radios.
XM: Adapter 2 for all XM Radios.

- Install the Radio Dock Adapter for your Radio into the Universal Boombox as shown. Align the Radio Dock Adapter in the Universal Boombox and gently press it until it snaps into place.

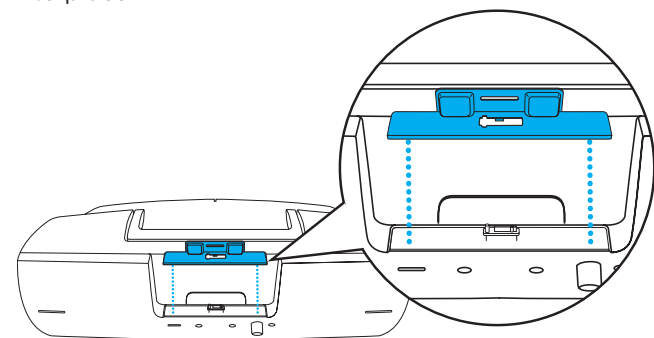

Removing the Radio Dock Adapter

If it becomes necessary to remove the Radio Dock Adapter, remember that the Radio Dock Adapters are constructed from precision molded plastic. During removal, extra care must be taken to not bend, force, or otherwise stress the adapter, or break off the tabs that hold the adapter in the Universal Boombox.

Remove the Radio Dock Adapter from the Universal Boombox by placing a coin, or your fingernail, into the slot at the back of the adapter, and pulling it up straight up, as shown.

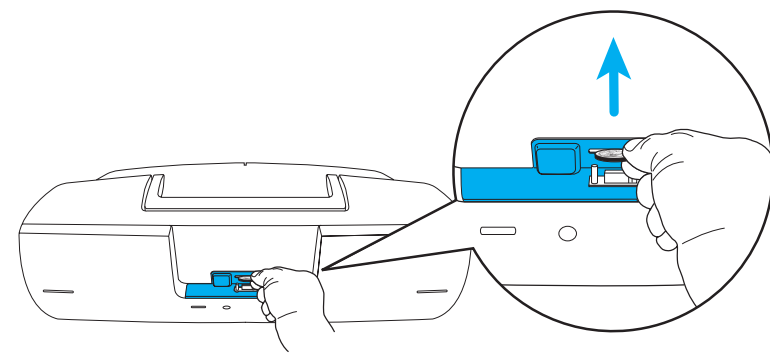

2. Install the Batteries or Home Power Adapter

The Universal Boombox can operate on either batteries (8 "D" cells) or by using the Home Power Adapter.

To use your Universal Boombox on-the-go:

- Open the two battery compartments on the bottom of the Universal Boombox. Insert 8 D-cell alkaline batteries, 4 in each in the battery compartment.

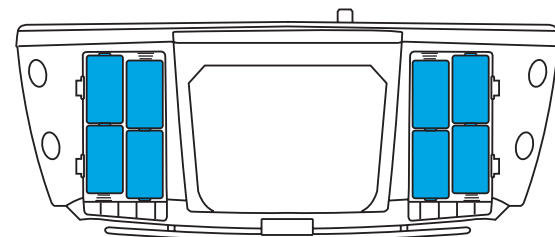

- Replace both battery compartment doors.

TIP! It is not recommended to keep batteries in the Universal Boombox for an extended length of time. Remove the batteries when not in use.

TIP! When the Universal Boombox is powered on the light on the front panel surrounding the Power/Volume knob is normally blue. When the light turns red, that indicates the battery power is low. Replace the batteries.

To use your Universal Boombox with the Home Power Adapter:

- Plug the Home Power Adapter into the connector labeled **12 V DC** at the rear of the Universal Boombox.
- Plug the other end of the Home Power Adapter into a standard wall outlet.

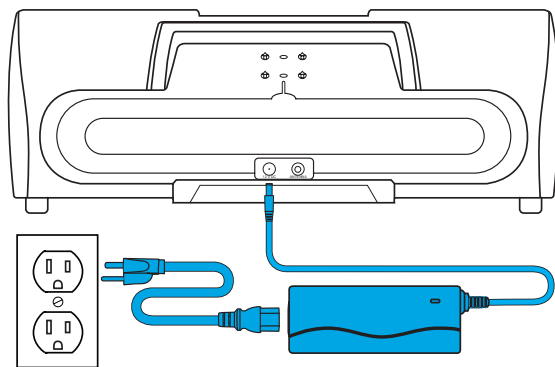

3. Install the Indoor/Outdoor Home Antenna

- Plug the antenna cable into the **ANTENNA** connector at the rear of the Universal Boombox.
- Wrap the antenna cable into the storage area.
- Place the antenna into the storage area at the rear of the Universal Boombox. Align the mounting holes on the bottom of the antenna with the 4 mounting brackets on the rear of the Universal Boombox. Push the antenna over the mounting brackets and then slide the antenna down slightly to secure it in place.
- Open the antenna clamshell so that the top of the antenna is facing the sky.

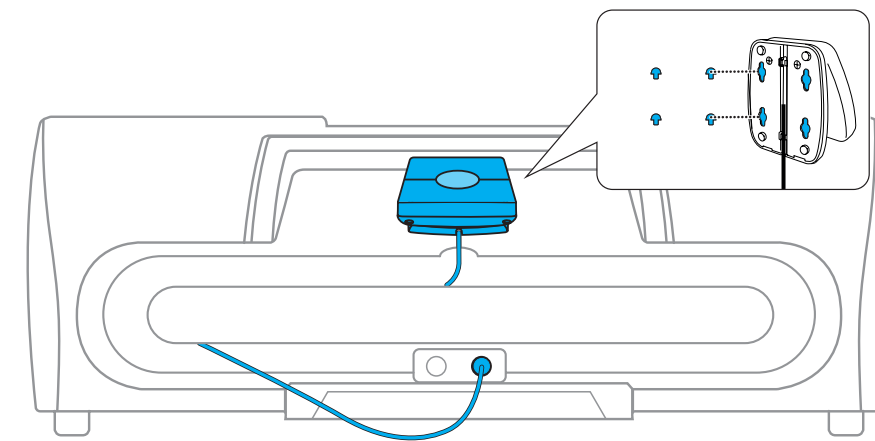

TIP! If you are using the Universal Boombox indoors, consult the User Manual for instructions for indoor antenna placement.

4. Insert Radio and Turn On the Universal Boombox

- Be sure the Universal Boombox is powered off.
- Align the Radio with the Radio Dock Adapter.
- Once aligned, gently press the Radio down so that it slides down the Radio Dock Adapter and onto the connector, until it is fully seated in the Universal Boombox.
- Press the **Power/Volume knob** at the front of the Universal Boombox until the Power On light is on.
- If your Radio did not automatically power on, press the **Power button** on your Radio.

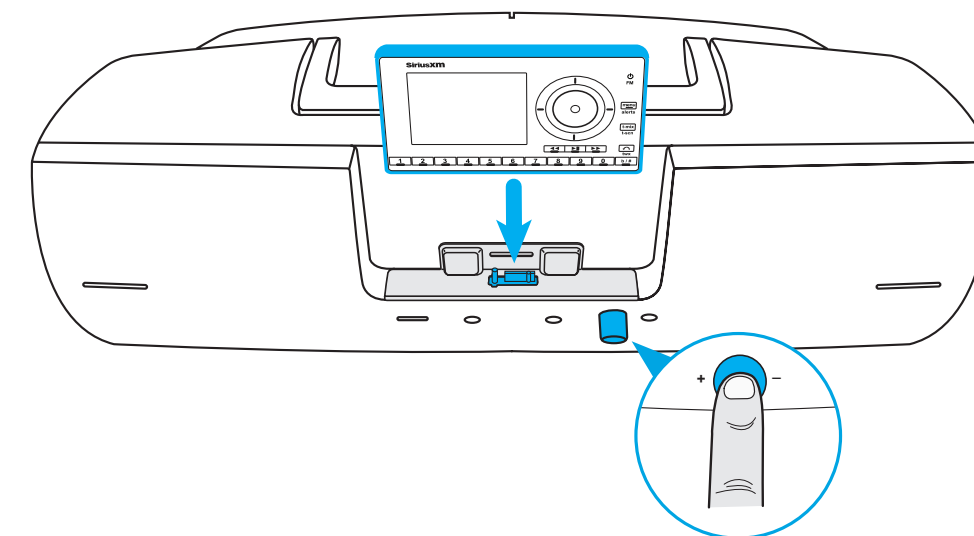

- If your Radio has an **Audio Level** or **Line Out Level** adjustment feature in the **Settings** menu when it's docked in the Universal Boombox, you should set this level to the maximum volume that does not cause distorted sound. This will maximize the audio quality. Refer to the User Guide which accompanied your Radio for instructions on how to set the level. Some Radios do not have this adjustment available when docked in the Universal Boombox. These Radios set their level automatically to optimize the sound quality. No adjustment is necessary.

The installation is complete. Sit back and enjoy your favorite programming on SiriusXM Radio!

Universal Boombox Controls and Connections

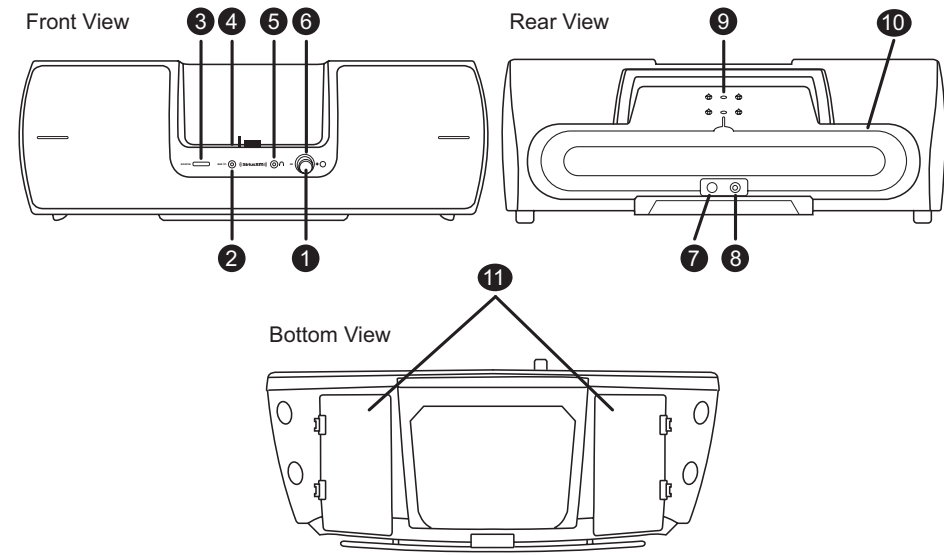

- 1. Power and Volume Knob:** Pressing the knob turns the Universal Boombox's power On or Off. Turning the knob increases or decreases the volume level (+/-).
- 2. AUX IN Connector:** Input connection for audio from an external device, such as an MP3 player, CD player etc.
- 3. Source Button:** Switches audio output between the Radio and the AUX input.
- 4. Radio Dock Adapter Slot:** Holds adapter for the Radio.
- 5. Headphone Connector:** Stereo headphone jack to privately listen to the Universal Boombox.
- 6. Power On/Low Battery Light:** The light is a constant blue when the Universal Boombox is powered on. The light will turn red when the batteries in the Universal Boombox are nearly discharged and need replacement.
- 7. DC Power Connector:** Connection for the Home Power Adapter. (12 V DC)
- 8. Antenna Connector:** Connection for the Indoor/Outdoor Home Antenna.
- 9. Antenna Storage:** Storage area for the Indoor/Outdoor Home Antenna.
- 10. Cable Storage:** Storage area for the antenna cable.
- 11. Battery Compartments:** Two battery compartments for a total of eight "D" size cells.

What's in the Box?

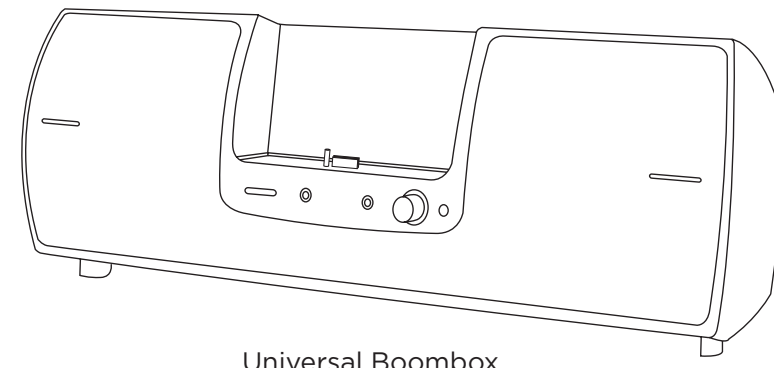

Universal Boombox

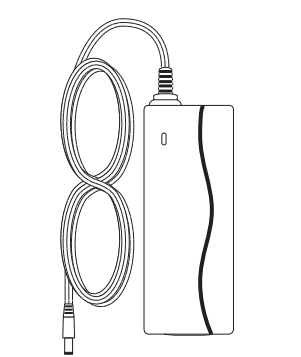

Home Power Adapter

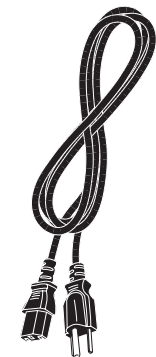

Power Cord

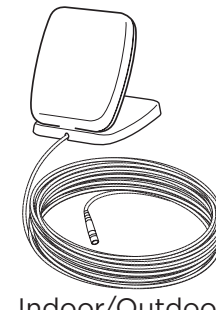

Indoor/Outdoor Home Antenna

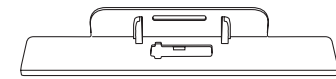

Adapter 1 (Sirius Radios)

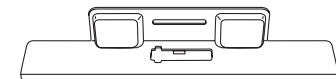

Adapter 2 (XM Radios)

Radio Dock Adapters

SiriusXM 12-Month Limited Warranty

What This Warranty Covers

This warranty covers defects in material and workmanship for 12 months from the date of purchase by the original retail purchaser only. SiriusXM Canada Inc., at its sole option, will repair or replace the product with a new or reconditioned product without charge for parts and labour. Products replaced under this warranty become the property of SiriusXM. Replacement products are warranted to be free from defects for 30 days or the remainder of the original warranty, whichever is longer.

What This Warranty Does Not Cover

This warranty does not cover: products sold as used, as is, reconditioned or refurbished; software stored on internal or removable memory; non-rechargeable batteries, surface preparation cleaners, adhesive pads, fasteners, and ear-buds; costs incurred for installation, removal or reinstallation of the product; correction of installation problems, such as elimination of externally generated static or noise and antenna placement and aiming; defects or damage caused by alteration, improper installation or removal, use of third party accessories, mishandling, misuse, neglect, accident, power surges or acts of nature.

How to Obtain Warranty Service

To obtain warranty service, please call Customer Care at 1-888-539-7474. You will be required to provide proof of purchase and a description of the defect. You must prepay the cost of shipping the product to an approved service center.

LIMITATIONS OF LIABILITY

THE LIABILITY OF SIRIUSXM UNDER THIS WARRANTY IS LIMITED TO REPAIR OR REPLACEMENT AS PROVIDED ABOVE AND IN NO EVENT SHALL THE LIABILITY EXCEED THE PURCHASE PRICE PAID FOR THE PRODUCT. ANY IMPLIED WARRANTIES, INCLUDING ANY IMPLIED WARRANTY OF MERCHANTABILITY OR FITNESS FOR A PARTICULAR PURPOSE, SHALL BE LIMITED TO THE DURATION OF THIS WRITTEN WARRANTY. ANY ACTION FOR BREACH OF WARRANTY, INCLUDING BREACH OF ANY IMPLIED WARRANTY OF MERCHANTABILITY, MUST BE BROUGHT WITHIN 48 MONTHS FROM THE DATE OF ORIGINAL PURCHASE. IN NO CASE SHALL SIRIUSXM BE LIABLE FOR ANY CONSEQUENTIAL OR INCIDENTAL DAMAGES FOR BREACH OF THIS OR ANY OTHER WARRANTY, EXPRESS OR IMPLIED. SOME PROVINCES DO NOT ALLOW LIMITATIONS ON HOW LONG AN IMPLIED WARRANTY LASTS OR THE EXCLUSION OR LIMITATION OF INCIDENTAL OR CONSEQUENTIAL DAMAGES, SO THE ABOVE LIMITATIONS OR EXCLUSIONS MAY NOT APPLY TO YOU. This warranty gives you specific legal rights and you may also have other rights, which vary from province to province.

If you experience problems with the operation or performance of your product

DO NOT RETURN THIS PRODUCT TO YOUR RETAILER

Call Customer Care at 1-888-539-7474

siriusxm.ca

Sirius XM Canada Inc.
135 Liberty St. - 4th floor
Toronto, Ontario, M6K 1A7

1-888-539-7474

Self installation instructions and tips are provided for your convenience. It is your responsibility to determine if you have the knowledge, skills and physical ability required to properly perform an installation. SiriusXM shall have no liability for damage or injury resulting from the installation or use of any SiriusXM or third party products. It is your responsibility to ensure that all products are installed in adherence with local laws and regulations and in such a manner as to allow a vehicle to be operated safely and without distraction. SiriusXM warranties do not cover the installation, removal or reinstallation of any product.

This Class B digital apparatus complies with Canadian ICES-003.

This device complies with Industry Canada license-exempt RSS standard(s). Operation is subject to the following two conditions: (1) this device may not cause interference, and (2) this device must accept any interference, including interference that may cause undesired operation of the device.

© 2016 Sirius XM Canada Inc.

SXMB2C QSG E 151128a



Quick Start Guide

Universal Boombox