



**User Guide**

**Onyx EZR  
Radio with Vehicle Kit**

<b>Introduction</b> .....	<b>3</b>
Features .....	3
Safety and Care Information .....	4
What's in the Box? .....	5
Onyx EZR Functions .....	6
<b>PowerConnect</b> Vehicle Dock .....	7
<b>Installation</b> .....	<b>8</b>
Step 1: Choose a Location for Your Radio .....	8
Step 2: Install the Dash or Vent Mount .....	9
Step 3: Mount the Magnetic Mount Antenna .....	11
Step 4: Route the Antenna Cable .....	13
Step 5: Connect the Magnetic Mount Antenna and <b>PowerConnect</b> Power Adapter .....	18
Step 6: Connect the Audio .....	19
<b>Activation</b> .....	<b>24</b>
<b>Using Your Onyx EZR</b> .....	<b>25</b>
Main Display screen .....	25
Navigation Basics .....	26
Tuning to a Channel .....	28
Direct Tune .....	28
Viewing a Category .....	28
Scanning Channels in a Category .....	28
Automatically Tuning Channels in Categories .....	29
Returning to the Main Display Screen .....	29
Jump and Traffic/Weather .....	29
Favorite Channels .....	30
FM Presets .....	31
Display Screen Mode .....	31
Parental Controls .....	32
TuneMix .....	35
<b>Where Else Can You Use Your Onyx EZR?</b> .....	<b>37</b>
<b>Configuring Your Onyx EZR</b> .....	<b>38</b>
Radio ID .....	38
FM Settings .....	38
Jump Settings .....	42
Display Settings .....	43
Feature Settings .....	44
Audio Level .....	45
Parental Controls .....	45
Signal Indicator .....	45
Auto Shut Off .....	46
Factory Settings .....	46
Restore Defaults .....	47
Demo Mode .....	47
<b>Troubleshooting</b> .....	<b>49</b>
<b>Product Specifications</b> .....	<b>51</b>
<b>Patent and Environmental Information</b> .....	<b>52</b>
<b>IC Statement</b> .....	<b>53</b>
<b>Copyrights and Trademarks</b> .....	<b>54</b>
<b>Owners Record</b> .....	<b>55</b>

## Features

---

Thank you for purchasing the XM Onyx EZR with Vehicle Kit!

SiriusXM Onyx EZR has these exciting features to enhance your overall experience:

- View artist or show name, song or program title and content or channel information on an easy-to-read large high-resolution display
- Store up to 10 of your favorite channels for one touch access
- Create your own music channel that's a blend of channels with TuneMix™
- Easily lock and unlock channels with mature content
- Browse what's playing on other channels while listening to the current one
- One-Touch Jump™ to the previous channel to which you were listening
- Enjoy SiriusXM Xtra Channels - 10 channels of additional commercial-free music
- Listen in multiple vehicles, at home, in the office or outdoors - all with just one subscription
- Hear SiriusXM through your existing vehicle stereo with easy, do-it-yourself installation<sup>1</sup>
- Includes PowerConnect™ Vehicle Kit - add optional accessories for your home, outdoors, or even vehicles.
- Store and easily access FM presets to optimize PowerConnect™ performance
- Works on the XM network

Please read the entire User Guide before using your Onyx EZR!

---

<sup>1</sup>. Requires an FM stereo or Aux In capability. Use the included Aux In cable if your vehicle has Aux In capability for best performance. Will also work with cassette adapter (sold separately).

## Safety and Care Information



**IMPORTANT!** Self installation instructions and tips are provided for your convenience. It is your responsibility to determine if you have the knowledge, skills, and physical ability required to properly perform an installation. SiriusXM shall have no liability for damage or injury resulting from the installation or use of any SiriusXM or third party products. It is your responsibility to ensure that all products are installed in adherence with local laws and regulations and in such a manner as to allow a vehicle to be operated safely and without distraction. SiriusXM product warranties do not cover the installation, removal or reinstallation of any product.

- Do not expose to extreme temperatures (above 140°F or below -4°F, or above 60°C or below -20°C).
- Do not expose to moisture. Do not use device near or in water. Do not touch the device with wet hands.
- Do not let any foreign matter spill into device.
- Do not store in dusty areas.
- Do not expose to chemicals such as benzene and thinners. Do not use liquid or aerosol cleaners. Clean with a soft damp cloth only.
- Do not expose to direct sunlight for a prolonged period of time, and do not expose to fire, flame, or other heat sources.
- Do not try to disassemble and/or repair device yourself.
- Do not drop your device or subject it to severe impact.
- Do not place heavy objects on device.
- Do not subject device to excessive pressure.
- If the LCD screen is damaged, do not touch the liquid crystal fluid.

### **Warning!**

- Opening the case may result in electric shock.
- If the liquid crystal fluid comes in contact with your skin, wipe the skin area with a cloth and then wash the skin thoroughly with soap and running water. If the liquid crystal fluid comes into contact with your eyes, flush the eyes with clean water for at least 15 minutes and seek medical care. If the liquid crystal fluid is ingested, flush your mouth thoroughly with water. Drink large quantities of water, and induce vomiting. Seek medical care.
- Make sure that you insert the *PowerConnect* Power Adapter all the way into the vehicle's cigarette lighter or power adapter socket.
- If you are using *PowerConnect* as your audio connection option, it is advisable not to insert a multi-outlet adapter into the same vehicle cigarette lighter or power adapter socket to simultaneously power other devices. Some multi-outlet adapters can prevent the *PowerConnect* feature from working properly.
- When using this product, it is always important to keep your eyes on the road and hands on the steering wheel. Not doing so could result in personal injury, death, and/or damage to your device, accessories, and/or to your vehicle or other property.
- Vehicle installation, service activation, and Radio configuration functions should not be performed while driving. Park your vehicle in a safe location before beginning installation.
- This product contains chemicals known to the State of California to cause cancer and birth defects or other reproductive harm.
- Your device should be placed in your vehicle where it will not interfere with the function of safety features, e.g., deployment of airbags. Failure to correctly place device may result in injury to you or others, if the unit becomes detached during an accident and/or obstructs the deployment of an airbag.

## What's in the Box?

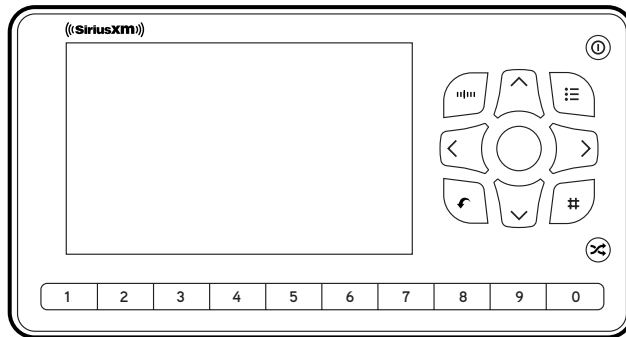

Onyx EZR Radio

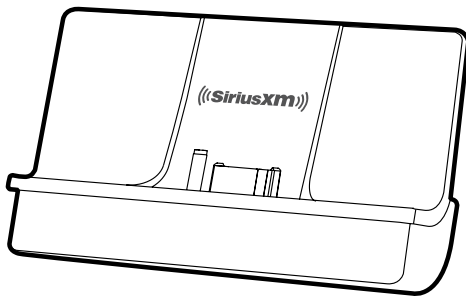

PowerConnect™ Vehicle Dock

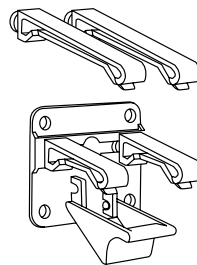

Vent Mount and  
Extended Vent Clamps

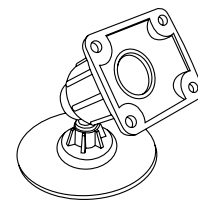

Dash Mount

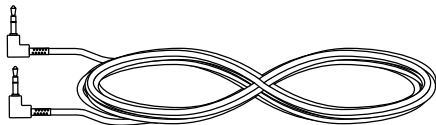

Aux In Cable

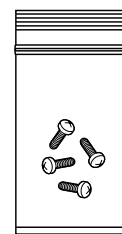

Screws (4)

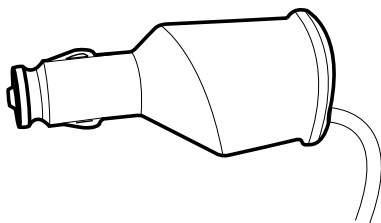

PowerConnect Power Adapter

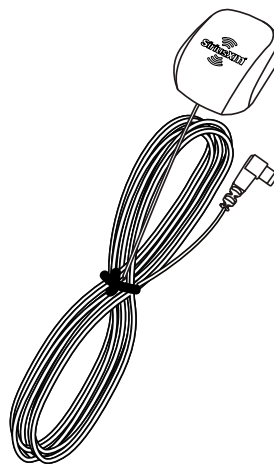

Magnetic Mount Antenna



Antenna & Dash  
Mount Alcohol  
Preparation Pads

## Onyx EZR Functions

### FM Button

Press to access and cycle through FM presets; **press and hold** to access FM settings.

### Up and Down Buttons

**Press** to preview and tune to channels through the channel lineup; **press and hold** to continuously scroll through channels; also **press** to scroll through lists and highlight items in lists.

### Power Button

**Press** to turn Radio on and off.

### Menu Button

**Press** to access advanced features and configuration options; when in configuration options, **press and hold** to return to main display screen.

### Left and Right Buttons

**Press** to search for channels by category; **press and hold** to continuously scroll through categories.

### Select Button

At the main display screen **press** to display and dismiss the favorite channel preview pane; **press** to confirm selection of highlighted item in a menu or list.

### Direct Button

**Press** to enter a channel number using the number buttons and directly tune to the channel.

### TuneMix Button

**Press** to begin TuneMix; **press and hold** to add or remove channels from TuneMix.

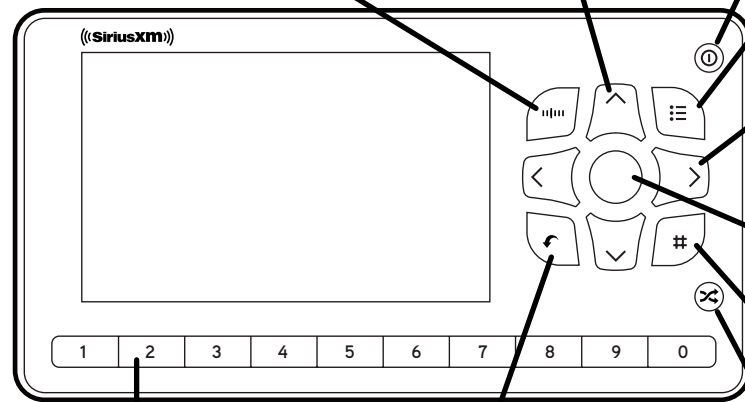

### Number Buttons

**Press** to tune to a stored favorite channel; **press and hold** to store a favorite channel. Also used to enter channel numbers when the Direct button is pressed.

### Jump Button

**Press** to go back to the previous channel to which you were listening; **press and hold** to change display screen mode.

## PowerConnect Vehicle Dock

### Color-Coded Connections

The color-coded *PowerConnect* Vehicle Dock makes it simple to connect. Just match the colors on the cable ends to the colors on the dock to see what goes where.

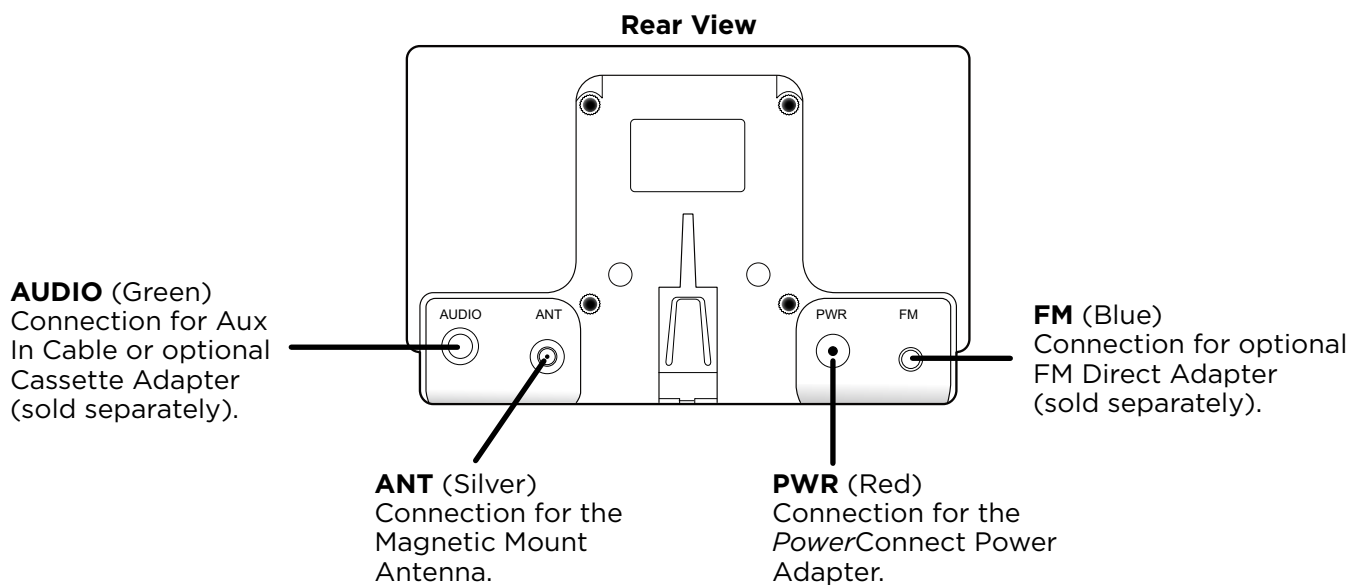

### Wire Guide

The *PowerConnect* Vehicle Dock has a wire guide at the top rear that can help you to organize the cables and wires connected to the dock. If you need to bring a cable or wire from one side of the dock to the other, utilize the wire guide by looping the cable through the wire guide as shown.

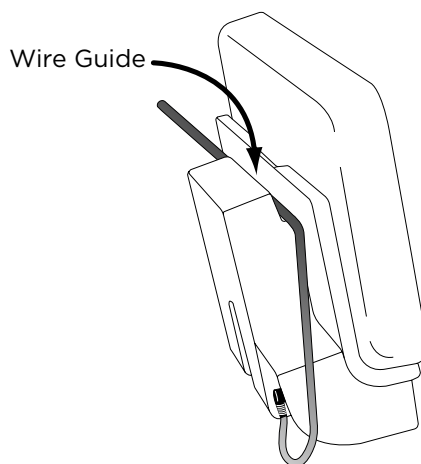



**WARNING! DO NOT** attempt to install Onyx EZR while driving. Park your vehicle in a safe location before beginning installation.

## Step 1: Choose a Location for Your Radio

When installing Onyx EZR in your vehicle, choose a location where it will not block your vision, interfere with the controls, or obstruct the air bag. The location should be easily accessible and provide good visibility of the display, and should not be located where it will be in direct sunlight, which will affect the visibility of the display screen.

Several examples of Onyx EZR mounted in a vehicle are shown: **A** is the on dash method using the Dash Mount, and **B** is the vent clip method using the Vent Mount.

Option 1

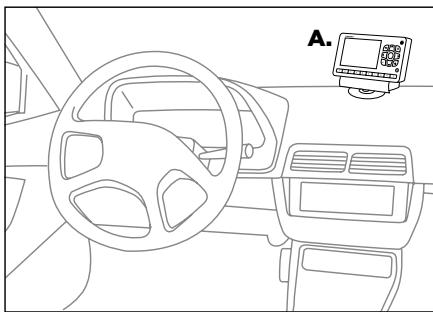

Option 2

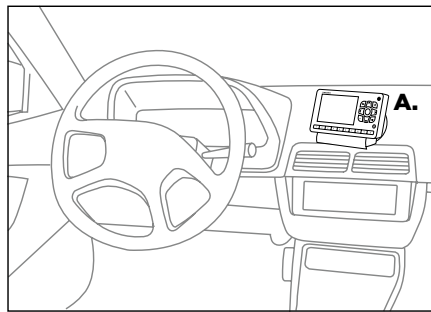

Option 3

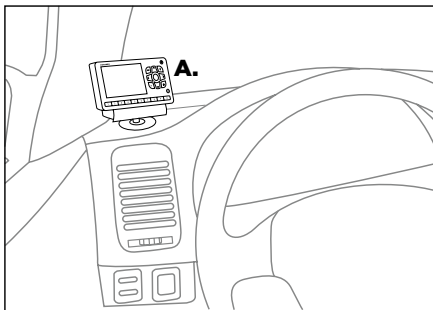

Option 4

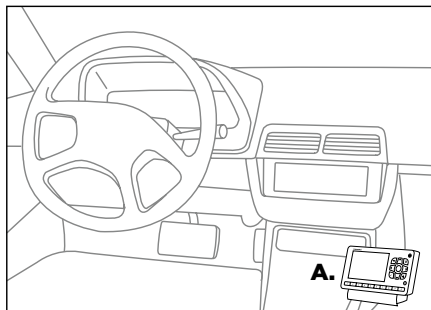

Option 5

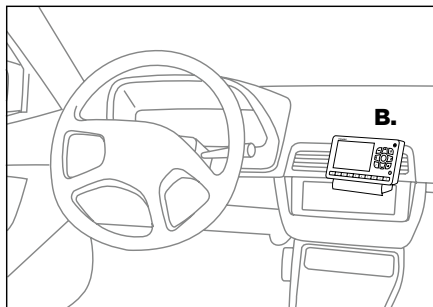

Option 6

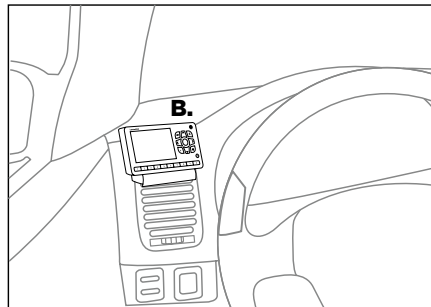



## Step 2: Install the Dash or Vent Mount

Follow the instructions on the next several pages for the mounting method you have selected.

### Installing the Adhesive Mount:



**CAUTION!** The adhesive used on the Adhesive Mount may be difficult to remove. Do not install this mount on leather surfaces (contact your automobile dealership if you are unsure about your dash surface), and make sure the air temperature is at least 60°F (15°C) during installation. If it's not at least 60°F, turn on the heater in your vehicle to bring the temperature up to 60°F.

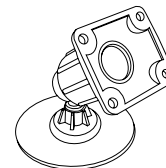

1. Locate a flat surface for the Adhesive Mount. Make sure there is ample room for the *PowerConnect* Vehicle Dock and Onyx EZR Radio when installed.
2. Set the orientation of the Adhesive Mount before adhering it. Loosen the knob and adjust the adhesive foot for the location you selected in “Step 1: Choose a Location for Your Radio” on page 8.

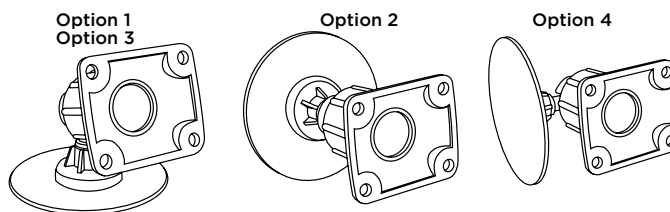

3. The dock mounting plate can be tilted in different directions. Adjust as necessary for your particular vehicle. When the orientation is correct, tighten the knob.

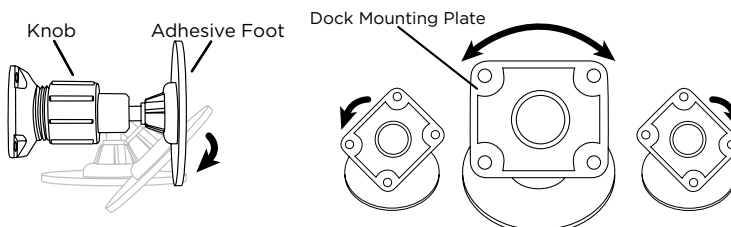

4. Attach the Adhesive Mount to the *PowerConnect* Vehicle Dock using the 4 provided screws.
5. Before you attach the Adhesive Mount to the dash, skip ahead and finish the remainder of the vehicle installation so that the cables are attached to the dock.
6. Once the cables have been attached to the dock, clean the mounting surface in the vehicle with the alcohol preparation pad and let it dry thoroughly.
7. Peel off the adhesive liner. Position, press, and hold the Adhesive Mount in place for 30 seconds.

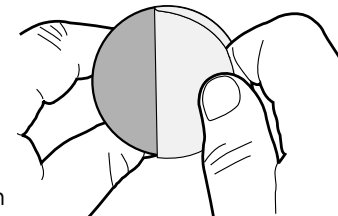
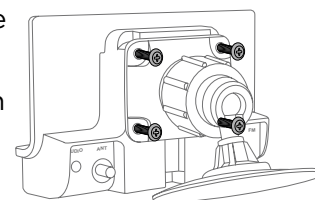

**IMPORTANT!** Allow the Adhesive Mount adhesive to cure (dry) for a minimum of 2-4 hours before using the mount. The best adhesion occurs after 24 hours.



**TIP!** To remove the Adhesive Mount, carefully lift the adhesive pad with your fingers or a spoon. Warming the pad with a hair dryer for several minutes will help soften the adhesive.

## Installing the Vent Mount:



**IMPORTANT!** To make the cable connections easier, wait until after you have connected all the cables to the dock before you attach the Vent Mount to a vent.

1. Locate a vent with horizontal louvers sturdy enough to hold your *PowerConnect* Vehicle Dock and Onyx EZR Radio.
2. If the vent louvers in your vehicle are recessed, you may need to use the longer vent clamps with the Vent Mount. If so, remove the shorter vent clamps and install the longer ones into the Vent Mount. Be sure to observe the orientation of the vent clamps as shown, and replace both vent clamps.

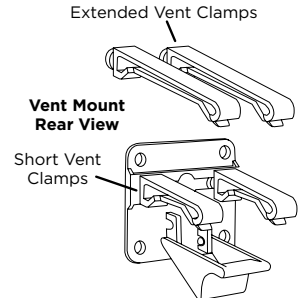

Vent Mount Rear View

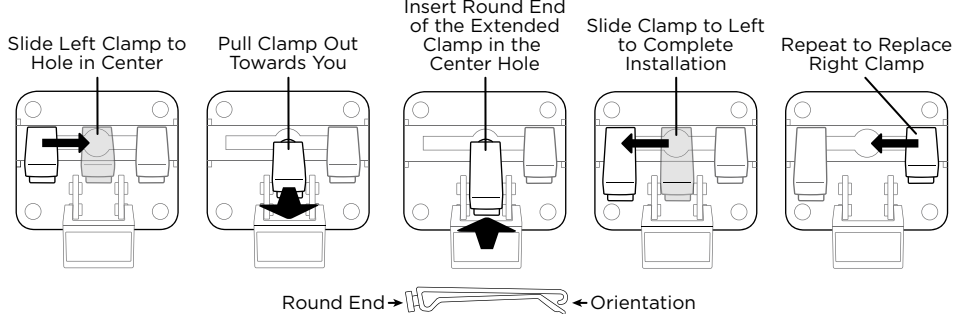

3. Attach the Vent Mount to the *PowerConnect* Vehicle Dock using the 4 provided screws.
4. Before you attach the Vent Mount to the vent, skip ahead and finish the remainder of the vehicle installation so that the cables are attached to the dock.

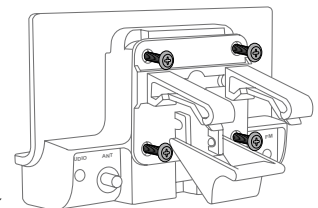

**NOTE!** For greater clarity, the next illustration does not show the dock attached to the Vent Mount, however, the dock should be attached before continuing.

5. Once the cables have been attached to the dock, push the Vent Mount onto the vehicle vent as shown (1) until it hooks on the rear of the vent louver (2).

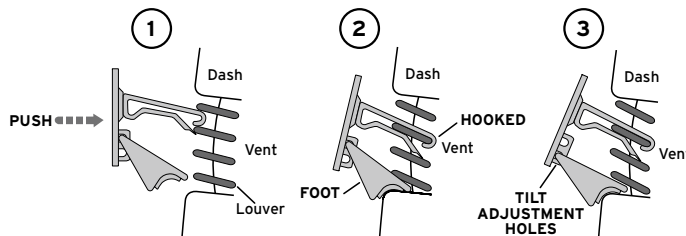

6. Rest the foot against the bottom of the vent (2), and adjust the tilt of the Vent Mount by repositioning the foot to the other adjustment hole (3).



**TIP!** To remove the Vent Mount, push the mount into the vent. Then lift up until disengaged from the rear of the vent louver, and remove the Vent Mount.

### Step 3: Mount the Magnetic Mount Antenna

Mount the Magnetic Mount Antenna on the outside of your vehicle, on a horizontal surface that will always face the sky. The antenna contains a strong magnet which will stick to any metal part of your vehicle, but will not damage the vehicle.

#### ***To install the Magnetic Mount Antenna:***

1. Choose the best location for your antenna considering your vehicle type. Pay particular attention to any accessories that you may have like luggage racks and how frequently you may use them.



**Sedan/Coupe:** We recommend mounting the antenna just above either the front windshield or the back window as shown.

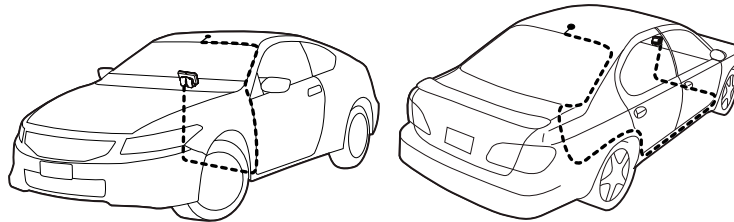

**SUV:** We recommend mounting the antenna at the rear of the roof as shown.

**Convertible:** We recommend mounting the antenna at the leading edge of the trunk as shown.

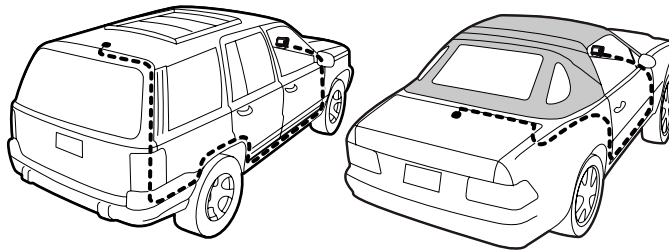

**Pickup Truck:** We recommend mounting the antenna just above the front windshield as shown.

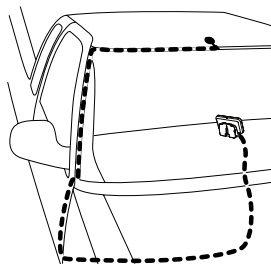

**IMPORTANT!** Consult a professional installer if your vehicle roof or hood is non-metallic (i.e., fiberglass), or you have difficulty finding a location for your antenna.

2. Clean the surface of the selected mounting location using the alcohol preparation pad and let it dry thoroughly.

3. Place the antenna in the location you selected. Follow the Tips and Cautions shown below.



**TIP!** Mount the antenna on the roof (for most vehicles) or trunk (for convertibles) where it has a clear view of the sky in all directions

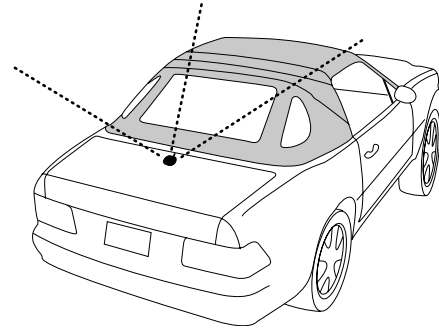
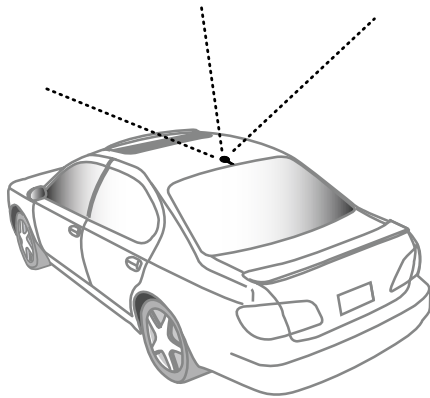

**CAUTION!** Don't mount the antenna inside the vehicle, for example, on the dashboard.

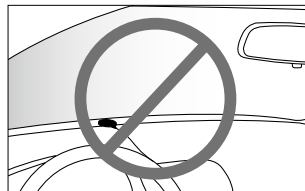

**CAUTION!** Don't mount the antenna on any of the vehicle's front, back or side pillars.

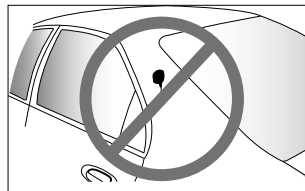

**CAUTION!** Don't mount the antenna close to a roof rack. Adjust the rack so it's further away from the antenna or move the antenna closer to the center of the roof.

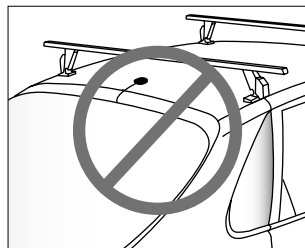

**CAUTION!** Don't mount the antenna close to another antenna. Mount it at least 3 inches away.

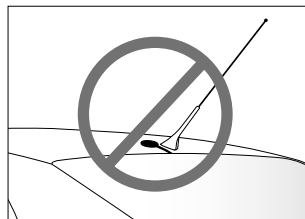

## Step 4: Route the Antenna Cable

Before you begin routing the antenna cable, read these general instructions for how to route and hide the antenna cable. Then route your antenna cable according to the step-by-step instructions which follow for your specific type of vehicle.

Use care when routing the antenna cable into and through the vehicle interior, avoiding sharp objects that can damage the cable. Keep the antenna cable away from moving parts such as gas, clutch, and brake pedals, trunk and door hinges, and sliding seat brackets. Hide the antenna wire inside the vehicle cabin by routing the cable under the carpet and behind plastic trim, toward the Tuner Module location. Coil and secure any excess cable in a hidden location, such as under the carpet, using wire ties (not included). **CAUTION!** Do not kink or sharply fold the antenna cable.

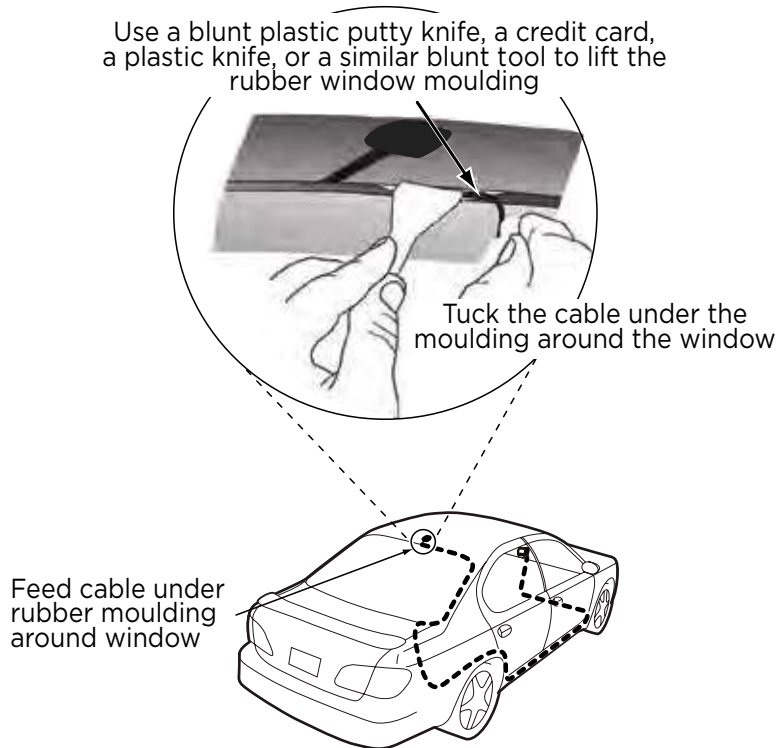

Route cable out from under rear windshield moulding and tuck into weatherstripping around trunk opening  
Avoid sharp bends by running cable through weatherstripping for several inches

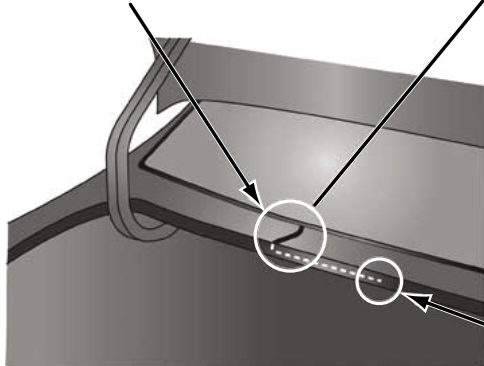

Tuck cable into weatherstripping. Route cable through weatherstripping several inches to avoid sharp bends

Pull cable out of weatherstripping and route through trunk to cabin

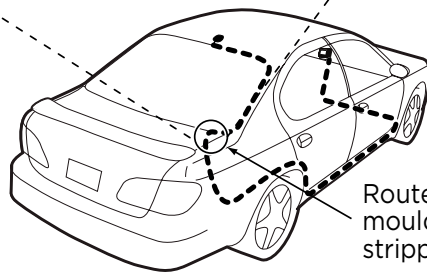

Route cable out of window moulding and into weatherstripping around trunk opening

Bring cable out of weatherstripping and into trunk

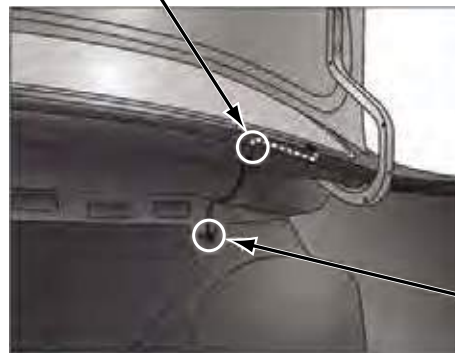

Route cable along trunk wall and into cabin through gap or conduit, along existing wiring harness

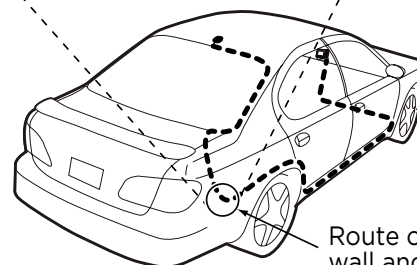

Route cable along trunk wall and into cabin

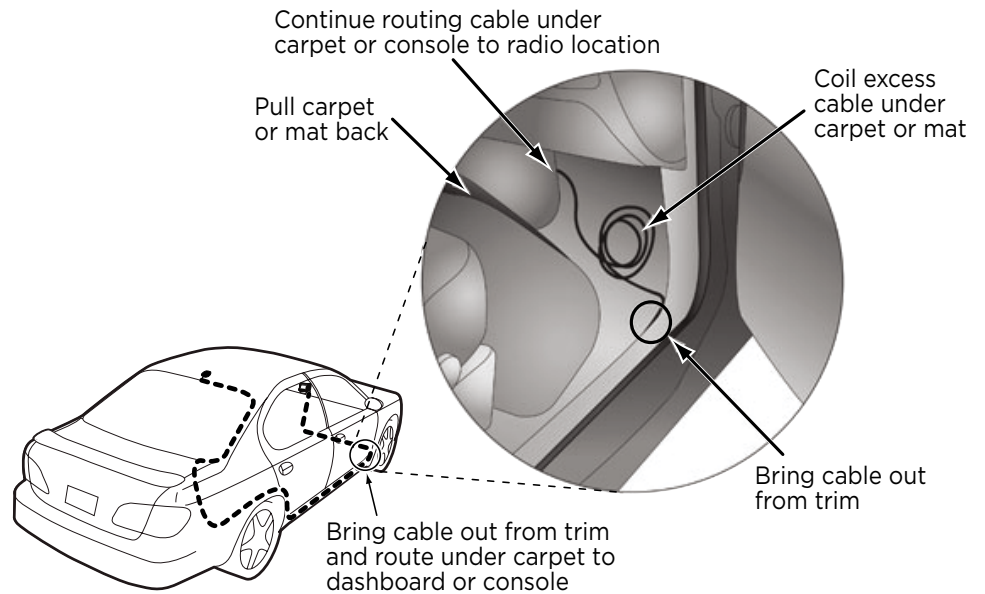
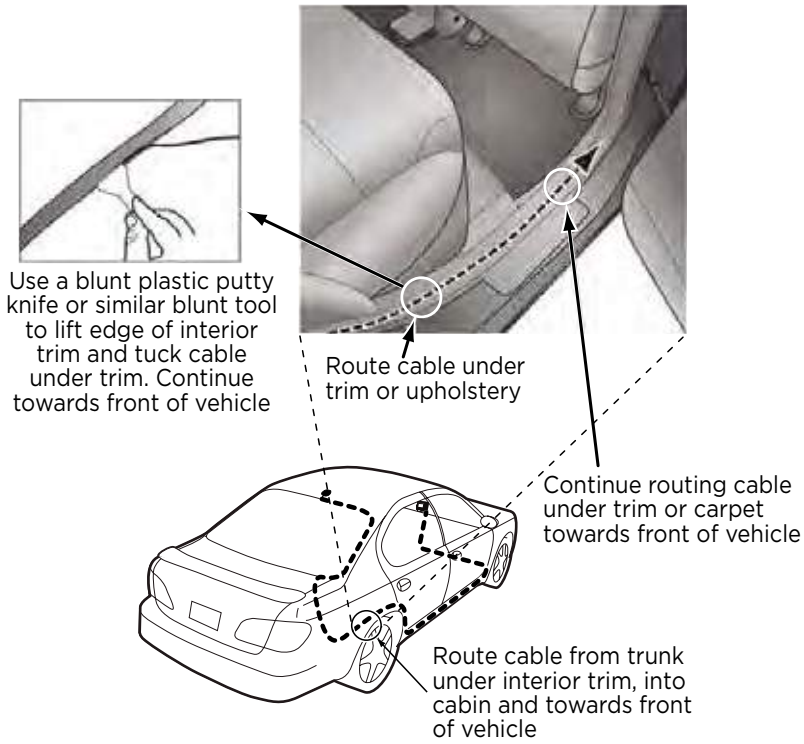

**TIP!** Always be careful to include enough slack in your cable to accommodate open doors or trunk lids. Use things typically found around the home, like electrical tape, to secure cables in areas so that hinges do not pinch the cable with the door. Hide any excess cable in the trim.

## **Sedan/Coupe With Antenna Placed at the Rear of the Roof:**

1. Feed the antenna cable from the antenna underneath the rubber molding around the rear window. Use a blunt plastic putty knife or similar blunt tool to lift the rubber molding around the rear window and tuck the antenna cable underneath the molding. Route the antenna cable around and down the window to the lowest point. If your rear window does not have rubber molding, we recommend consulting a professional installer.
2. Route the antenna cable out of the window molding and into the rubber weather stripping around the trunk opening. Lift the weather stripping from the opening and tuck the cable inside it, then replace the weather stripping. To avoid sharp bends in the cable, run the cable inside the weather stripping for a few inches, then remove the cable from the weather stripping inside the trunk. Keep the cable away from hinges, gears, etc., that could damage it.
3. Route the cable out from the rubber weather stripping and along the trunk wall. Continue routing the cable into the vehicle cabin through a conduit or along an existing wiring harness.
4. Route the cable through the main cabin area under the interior trim, towards the front of the vehicle. Use a blunt plastic putty knife or similar blunt tool to lift the plastic trim just enough to tuck the cable under underneath. Avoid side airbag locations on back pillars and above the doors. Airbag locations are marked with “SRS” logos. Be careful not to crimp or cut the cable.
5. Bring the cable out from the trim near the front of the cabin and route it under the carpet toward the dashboard or console. Coil any excess cable in a hidden location, such as under the carpet, keeping it away from any vehicle pedals or controls. Secure the excess cable with wire ties (purchased separately).
6. Bring the end of the cable out at the PowerConnect Vehicle Dock location. Leave yourself enough cable so you can easily connect it to the antenna connector of the dock.
7. Continue with “Step 5: Connect the Magnetic Mount Antenna and PowerConnect Power Adapter” on page 18.

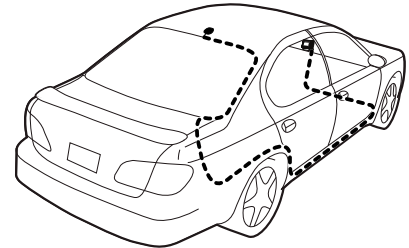

## **Sedan/Coupe With Antenna Placed at the Front of the Roof**

1. Feed the antenna cable from the antenna underneath the rubber molding around the windshield. Use a blunt plastic putty knife or similar blunt tool to lift the rubber molding around the windshield and tuck the antenna cable underneath the molding. Route the antenna cable around and down the windshield to the lowest point.
2. At the lowest corner of the windshield, route the cable out of the windshield molding and into the rubber weather stripping around the door opening. Lift the weather stripping from the opening and tuck the cable inside it, then replace the weather stripping. Run the cable inside of the weather stripping to the bottom of the door opening.
3. Pull the cable out of the weather stripping at the bottom of the door opening and route it under the carpet toward the dashboard. Coil any excess cable in a hidden location, such as under the carpet, keeping it away from any vehicle pedals or controls. Secure the excess cable with wire ties.
4. Bring the end of the cable out at the PowerConnect Vehicle Dock location. Leave yourself enough cable so you can easily connect it to the antenna connector of the dock.
5. Continue with “Step 5: Connect the Magnetic Mount Antenna and PowerConnect Power Adapter” on page 18.

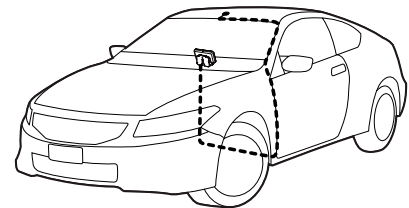



**Sport Utility Vehicle (SUV)**

1. Feed the antenna cable underneath the rubber weather stripping of the rear tailgate window/door and route the cable along the rear hatch. Lift the weather stripping from the opening and tuck the cable inside it, then replace the weather stripping. Pull the cable out from weather stripping and route it into the cabin under the interior trim. Avoid hinges or gears that could crimp or cut the cable.
2. Route the cable through the SUV's main cabin area under the interior trim, towards the front of the vehicle. Use a blunt plastic putty knife or similar blunt tool to lift the plastic trim just enough to tuck the cable under underneath. Avoid side airbag locations on back pillars and above the doors. Airbag locations are marked with "SRS" logos. Be careful not to crimp or cut the cable.
3. Bring the cable out from the trim near the front of the cabin and route it under the carpet toward the dashboard or console. Coil any excess cable in a hidden location, such as under the carpet, keeping it away from any vehicle pedals or controls. Secure the excess cable with wire ties (purchased separately).
4. Bring the end of the cable out at the *PowerConnect* Vehicle Dock location. Leave yourself enough cable so you can easily connect it to the antenna connector of the dock.
5. Continue with "Step 5: Connect the Magnetic Mount Antenna and PowerConnect Power Adapter" on page 18.

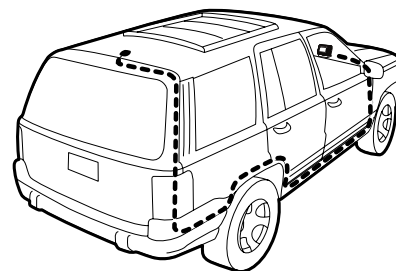
**Convertible**

1. Bring the antenna cable from the antenna into the trunk at the front edge of the trunk lid. Keep any bends in the cable loose. Tape or tie the cable along the inside of the trunk lid to the trunk lid hinge strut.
2. Allow enough slack in the cable so the trunk lid can easily open and close and keep the cable away from hinges, gears, etc., that could crimp or cut it. Route the cable along the trunk wall and into the cabin through a conduit or along an existing wiring harness.
3. Route the cable through the main cabin area under the interior trim, towards the front of the vehicle. Use a blunt plastic putty knife or similar blunt tool to lift the plastic trim just enough to tuck the cable under underneath. Avoid side airbag locations on back pillars and above the doors. Airbag locations are marked with "SRS" logos. Be careful not to crimp or cut the cable.
4. Bring the cable out from the trim near the front of the cabin and route it under the carpet toward the dashboard or console. Coil any excess cable in a hidden location, such as under the carpet, keeping it away from any vehicle pedals or controls. Secure the excess cable with wire ties (purchased separately).
5. Bring the end of the cable out at the *PowerConnect* Vehicle Dock location. Leave yourself enough cable so you can easily connect it to the antenna connector of the dock.
6. Continue with "Step 5: Connect the Magnetic Mount Antenna and PowerConnect Power Adapter" on page 18.

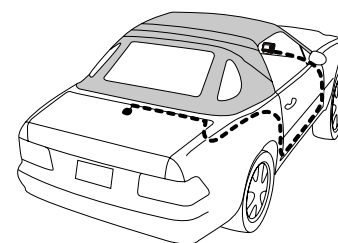
**Pickup Truck**

1. Use a blunt plastic putty knife or similar blunt tool to lift the rubber molding around the windshield and tuck the antenna cable underneath it.

2. Continue tucking the cable underneath the windshield molding around the windshield to the lowest corner.
3. At the lowest corner of the windshield, route the cable out of the windshield molding and into the rubber weather stripping around the door opening. Lift the weather stripping from the opening and tuck the cable inside it, then replace the weather stripping. Run the cable inside of the weather stripping to the bottom of the door opening.
4. Pull the cable out of the weather stripping at the bottom of the door opening and route it under the carpet toward the dashboard. Coil any excess cable in a hidden location, such as under the carpet, keeping it away from any vehicle pedals or controls. Secure the excess cable with wire ties.
5. Bring the end of the cable out at the *PowerConnect* Vehicle Dock location. Leave yourself enough cable so you can easily connect it to the antenna connector of the dock.
6. Continue with “Step 5: Connect the Magnetic Mount Antenna and *PowerConnect* Power Adapter” on page 18.

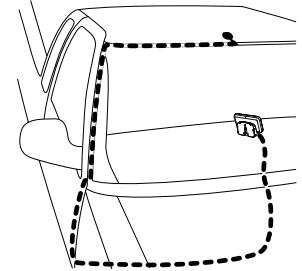

## Step 5: Connect the Magnetic Mount Antenna and *PowerConnect* Power Adapter

1. Plug the Magnetic Mount Antenna into the **silver ANT** connector on the *PowerConnect* Vehicle Dock.
2. Insert the *PowerConnect* Power Adapter into your vehicle's cigarette lighter or power adapter socket.
3. Plug the *PowerConnect* Power Adapter into the **red PWR** connector on the dock.

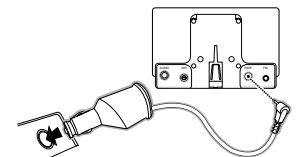
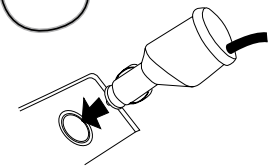
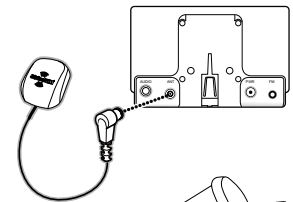

## Step 6: Connect the Audio

---

To play XM audio through your vehicle's stereo or FM radio, decide on one of the following audio connection options:

- **Option 1: Best:** Use the provided **Aux In Cable** if your vehicle's stereo system has an auxiliary input connection or jack. Refer to your vehicle's owners manual to find the location of the auxiliary input jack, or consult the vehicle dealer.



**TIP!** The auxiliary input jack may be located on the face plate of the vehicle radio, on the back of the radio, anywhere on the front dash panel, inside the glove compartment, or inside the center console in between the front seats.

- **Option 2: Better:** Use a **Cassette Adapter** if your vehicle has a built-in cassette player. Cassette Adapters are sold separately and can be purchased from an electronics retailer, or go to [siriusxm.ca/shop](http://siriusxm.ca/shop).
- **Option 3: Good:** Use the **PowerConnect** feature of Onyx Plus. *PowerConnect* plays the audio through your vehicle's FM radio.
- **Option 4: Best:** Use the **FM Direct Adapter**. If none of the previous three audio connection options will work in your vehicle, then you will need to use the FM Direct Adapter (FMDA) (sold separately). The FMDA needs to be installed by a professional installer and directly connects Onyx Plus to your vehicle's FM radio. To learn more, check with the retailer where you bought your Radio, or go to [siriusxm.ca/shop](http://siriusxm.ca/shop).

Follow the installation instructions in the next several sections for the audio connection option that you have selected.

## Option 1: Aux In Cable Installation Instructions

1. Plug one end of the Aux In Cable into the **green AUDIO** connector on the dock.

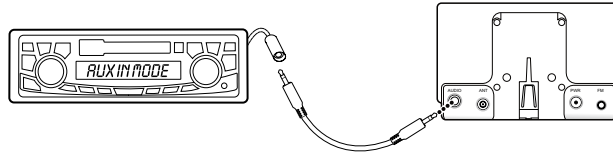

2. Plug the other end into the auxiliary input jack of your vehicle's stereo system.
3. If you are using the vent mounting method, attach the Vent Mount to the vehicle vent.
4. Insert your Onyx EZR into the dock.
5. Power on your Onyx EZR by pressing the **Power button**.
6. Be sure the vehicle is outside and the antenna has a clear view of the sky. Verify that you are receiving the XM signal. There should be at least two bars on the lower left corner of the main display screen that denotes antenna signal strength. You can also press **Menu** and then press **down ▼** to scroll to and highlight **Signal Indicator**. Press the **Select button**. The Satellite and Terrestrial bars show the strength of the signal being received. If the signal reception is good, press and hold **Menu** to return to the main display screen.
7. Ensure Onyx EZR is tuned to channel 1, the XM Preview channel. Upon power up, Onyx EZR should tune to channel 1 by default, when it's not yet activated. If it's not on channel 1, refer to "Tuning to a Channel" on page 28 to learn about how to tune a channel.
8. Turn on your vehicle's stereo system. Set it to play from the auxiliary input source. You should hear XM channel 1 through your vehicle's stereo system. You are now ready to activate your Onyx EZR.
9. Go back to "Step 2: Install the Dash or Vent Mount" on page 9 and finish installing the Dash or Vent Mount. Then the installation is complete.
10. The audio level output of Onyx EZR can be increased or decreased as necessary to match the audio levels of other sources in your vehicle. Refer to "Audio Level" on page 45.

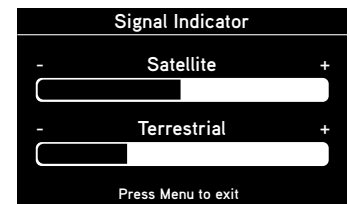
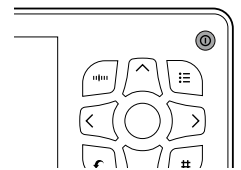
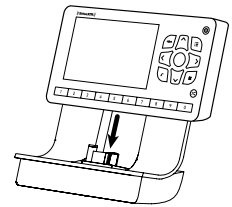

If the signal reception is good, showing at least two bars in the lower left corner of the display, but there is no XM audio, be sure the vehicle's stereo system is set to the auxiliary input source (step 8). Also be sure that the audio level is set high enough to be heard (step 10). Refer to "Troubleshooting" on page 49 for additional help.

## Option 2: Cassette Adapter Installation Instructions

1. Plug the Cassette Adapter into the **green AUDIO** connector on the dock.

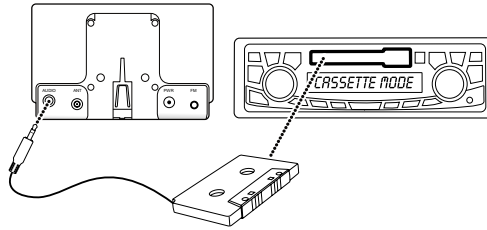

2. Insert the Cassette Adapter into the vehicle's cassette deck. You may need to turn on your vehicle's stereo system in order to do so.
3. If you are using the vent mounting method, attach the Vent Mount to the vehicle vent.
4. Insert your Onyx EZR into the dock.
5. Power on your Onyx EZR by pressing the **Power button**.
6. Be sure the vehicle is outside and the antenna has a clear view of the sky. Verify that you are receiving the XM signal. There should be at least two bars in the lower left corner of the main display screen that denotes antenna signal strength. You can also press **Menu** and then press **down ▼** to scroll to and highlight **Signal Indicator**. Press the **Select button**. The Satellite and Terrestrial bars show the strength of the signal being received. If the signal reception is good, press and hold **Menu** to return to the main display screen.
7. Ensure Onyx EZR is tuned to channel 1, the XM Preview channel. Upon power up, Onyx EZR should tune to channel 1 by default, when it's not yet activated. If it's not on channel 1, refer to "Tuning to a Channel" on page 28 to learn about how to tune a channel.
8. Turn on your vehicle's stereo system. Set it to play from the auxiliary input source. You should hear XM channel 1 through your vehicle's stereo system. You are now ready to activate your Onyx EZR.
9. Go back to "Step 2: Install the Dash or Vent Mount" on page 9 and finish installing the Dash or Vent Mount. Then the installation is complete.
10. The audio level output of Onyx EZR can be increased or decreased as necessary to match the audio levels of other sources in your vehicle. Refer to "Audio Level" on page 45.

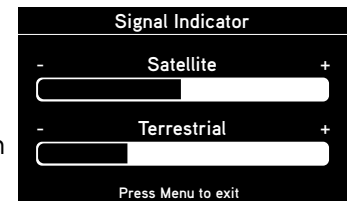
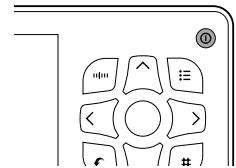
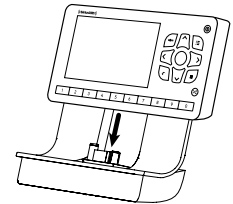

If the signal reception is good, showing at least two bars in the lower left corner of the display, but there is no XM audio, be sure the vehicle's stereo system is set to the cassette source (step 4). Also be sure that the audio level is set high enough to be heard (step 5). Refer to "Troubleshooting" on page 49 for additional help.

## Option 3: **PowerConnect** Installation Instructions

1. If you are using the vent mounting method, attach the Vent Mount to the vehicle vent.
2. Insert your Onyx EZR into the dock.
3. Power on your Onyx EZR by pressing the **Power button**.
4. Be sure the vehicle is outside and the antenna has a clear view of the sky. Verify that you are receiving the XM signal. There should be at least two bars in the lower left corner of the main display screen that denotes antenna signal strength. You can also press **Menu** and then press ▼ to scroll to and highlight **Signal Indicator**. Press the **Select button**. The Satellite and Terrestrial bars show the strength of the signal being received. If the signal reception is good, press and hold **Menu** to return to the main display screen.
5. You'll first need to find an available FM channel. An available FM channel is one that's not being used by an FM radio station in your area. When you tune your FM radio to an available channel, you should only hear static or silence – not talk or music. We recommend one of the following methods to find an available FM channel:
  - a. Use the SiriusXM FM Channel Finder at [siriusxm.ca/fm](http://siriusxm.ca/fm). Go to the website and enter your zip code. The Channel Finder will suggest a list of available FM channels in your area. For convenience, write down or print out the list.

**OR**

- b. Manually tune through your local FM channels on your vehicle's FM radio. Locate and create a list of channels that aren't being used by any FM radio station. Write down the list. Once you have created your list of available FM channels, you will need to find the one that provides the best match for Onyx EZR.



**TIP!** You'll need to use the 'Manual' tune function on your vehicle's FM radio to tune through every FM channel one-by-one. Turn on your vehicle's FM radio. Start at 88.1 and use the 'Manual' tune function on your vehicle's FM radio to tune through each FM channel one-by-one (88.1 followed by 88.3 etc.) to locate channels that aren't being used by a local FM radio station. Write down each FM channel that has only static or silence on it, until you reach 107.9.

6. Ensure Onyx EZR is tuned to channel 1, the XM Preview channel. Upon power up, Onyx EZR should tune to channel 1 by default, when it's not yet activated. If it's not on channel 1, refer to "Tuning to a Channel" on page 28 to learn about how to tune a channel.
7. Pick the first FM channel on your list from step 5. Turn on your vehicle's FM radio (if you have not already done so) and tune it to this FM channel.
8. Set your Onyx EZR to transmit on the same FM channel that you have selected in step 7:
  - i. Press **Menu**.
  - ii. Press ▼ to scroll to and highlight **FM Settings** and press the **Select button**.
  - iii. **FM Channels** will be highlighted. If it is not highlighted, press ▼ to scroll to and highlight **FM Channels**. Press the **Select button**.

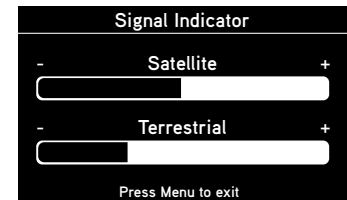
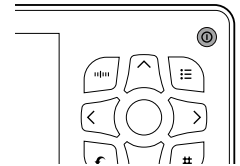
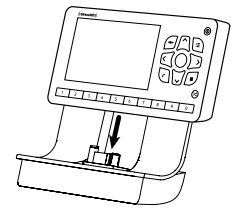

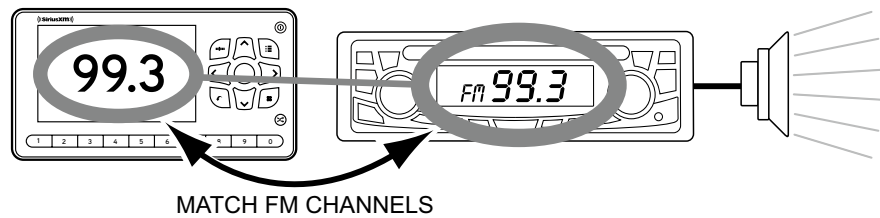

- iv. Press ▼ to scroll to and highlight the storage location **FM 2** and press the **Select button**.
- v. Tune to the available FM channel you choose in step 3. Press ◀ and ▶ to tune in steps of .2, i.e., 99.3 to 99.5. Press ▼ and ▲ to tune in steps of 1, i.e., 99.3 to 100.3. Press the **Select button** to select the FM channel.
- vi. **Start Using** is highlighted. Press the **Select button**.
- vii. The FM channel you selected will be confirmed on the display screen. Onyx EZR will tune to the FM channel.

FM Channels		
FM 1	97.9	current
FM 2	---	
FM 3	---	
FM 4	---	
FM 5	---	



- 9. You should hear XM channel 1 through your vehicle’s FM radio. If you are satisfied with the sound quality, the installation is complete. You are now ready to activate your Onyx EZR.
- 10. Go back to “Step 2: Install the Dash or Vent Mount” on page 9 and finish installing the Dash or Vent Mount. Then the installation is complete.
- 11. If the selected FM channel doesn’t work well for you, work down the list of FM channels until you find one with which you are satisfied. Each time, you will need to tune your vehicle’s FM radio to the FM channel and then set your Onyx EZR to transmit on the same FM channel (steps 7 & 8).

If the signal reception is good, showing at least two bars in the lower left corner of the display, but there is no XM audio, verify that both Onyx EZR and your vehicle’s FM radio are tuned to the same FM channel (steps 7 & 8). Also ensure the chosen FM channel is a suitable one to use in your area (step 5). Verify that nothing is plugged into the **AUDIO** connector on the *PowerConnect Vehicle Dock*. Refer to “Troubleshooting” on page 49 for additional help.

### Option 4: FM Direct Adapter (FMDA) Installation

The FMDA needs to be installed by a professional installer. Professional installation can help improve your Radio’s reception and significantly reduce the visibility of wires. To learn more, check with the retailer where you bought your Radio, or go to [siriusxm.ca/shop](http://siriusxm.ca/shop).

You can follow either the general activation and subscription process or use the on-board activation guide to activate your Onyx EZR and subscribe to the XM service.

## General activation and subscription process:

Subscribe to the XM service by following these steps:

1. Make sure your Onyx EZR is turned on, tuned to XM Preview channel 1, and receiving the XM signal so that you can hear the XM audio.
2. Make a note of the XM Radio ID. You can find it:
  - by selecting **Radio ID** in menu items
  - on channel 0 (zero)
  - on a label on the bottom of the gift box
  - on the label on the back of your Onyx Plus



\*The phone number show above may differ from the one shown on your Onyx EZR. All numbers are valid.



**NOTE!** The XM Radio ID does not use the letters I, O, S, or F.

3. To subscribe:
  - Online: Go to [siriusxm.ca/activate](http://siriusxm.ca/activate) to access or set up an online account, subscribe to the service, and activate your Radio.OR
  - By phone: Call **1-888-539-7474**.

Activation usually takes 10 to 15 minutes after you have completed the subscription process, but may take up to an hour. We recommend that your Radio remain on until subscribed. Once subscribed, the Radio will receive and you can tune to channels in your subscription plan.

Press **up ▲** or **down ▼** to tune to other channels, and **left ◀** or **right ▶** to browse the different categories of channels. Learn what all the buttons do by turning to “Navigation Basics” on page 26.

## Activation guide:

For your convenience, Onyx EZR has an on-board activation guide. You can activate your radio and subscribe to the XM service by using this guide, where you will be guided step-by-step through the subscription process. To access and use the guide, simply follow these steps:

1. Turn Onyx EZR on and press the **Menu button**.
2. **Activate Radio** will be highlighted. Press the **Select button**.
3. Follow the directions on each successive screen until you complete the subscription process.

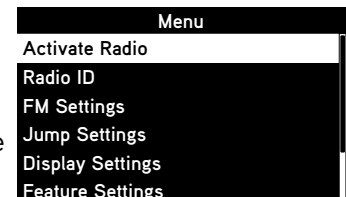



## Main Display screen

When listening to a channel, information about the channel and what is currently playing is displayed on the screen.

The favorite channel preview pane can be toggled by pressing the **Select** button at the main display screen. Press once to display the first five favorite channels, press again to display the second five favorite channels, and press again to close the preview pane.

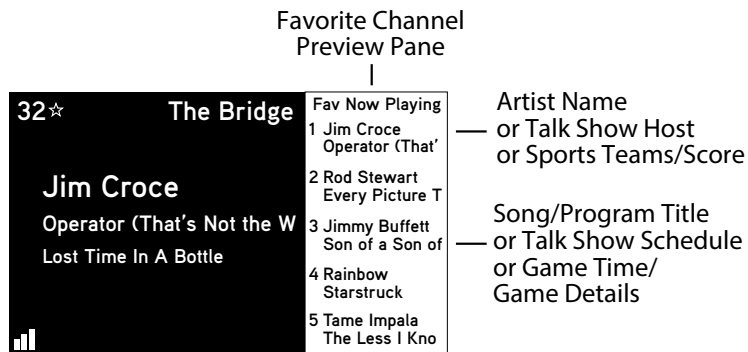
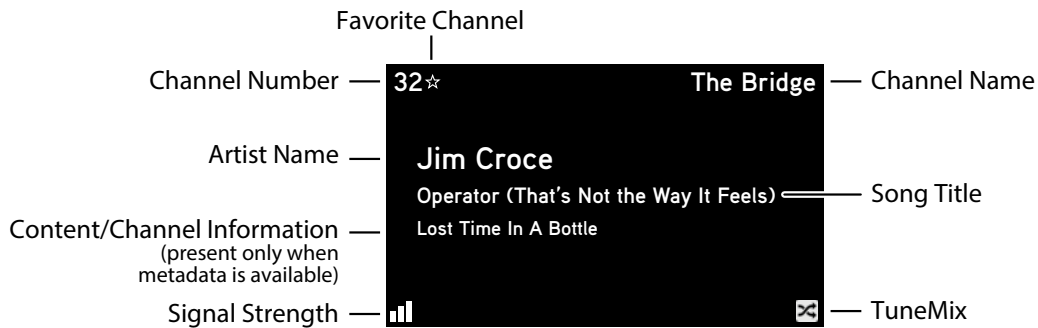
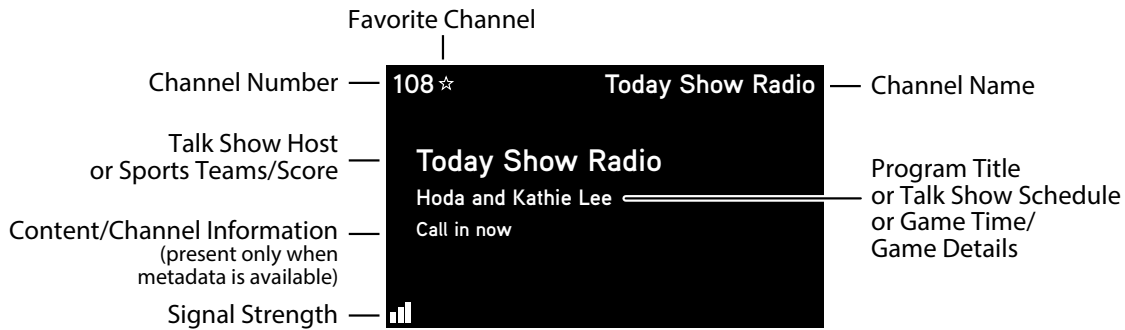

## Navigation Basics

### Power Button



Pressing the **Power button** turns Onyx EZR On or Off.

### Navigation Buttons

Pressing **Left**, **Right**, **Up**, and **Down** navigates through various features and functions of Onyx EZR.

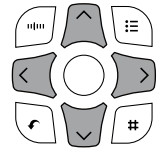

**Left ◀ or Right ▶ button:** Displays the channel categories such as Rock, Pop, Sports, Talk/News, etc. Repeated presses cycle through the categories one at a time. Also, decreases or increases the settings of various menu options such as Brightness, Audio Level, etc.

**Up ▲ or Down ▼ button (press and release):** Immediately tunes to the next or previous channel in the channel lineup. Also, scrolls through lists and highlights an item in the list.

**Up ▲ or Down ▼ button (press and hold):** Continuously scrolls through any list. While on the main display screen, continuously scrolls through the channel lineup and briefly displays the information of each channel. When the button is released, Radio tunes to the last channel it had scrolled to in the channel lineup.

### Select Button

Pressing the **Select button** displays and dismisses the favorite channel preview pane at the main display screen.

Pressing the **Select button** selects a highlighted item in a list and confirms settings.



### Menu Button

Pressing **Menu** displays various options to make setup and feature changes. Pressing **Menu** when in menu options returns to the previous menu option screen until menu options is exited. Pressing and holding **Menu** returns to the main display screen in most instances.



### FM Button

Pressing **FM** provides easy tuning of FM presets for optimized *PowerConnect* performance. Repeatedly pressing **FM** displays and cycles through the list of preset FM channels one at a time. The Radio automatically tunes to the displayed FM channel. Pressing and holding **FM** accesses the FM Settings menu. It is not available when Aux In Cable or Cassette Adapter is used for audio connection.



### Jump Button

Pressing and holding **Jump** toggles the display screen between black background with white text and white background with black text.

Please note that Traffic/Weather channels are not available to Canadian subscribers.



### Direct Button

Pressing **Direct** prompts for the entry of a channel number using the number buttons. Once the channel number is entered, the Radio directly tunes to the new channel.



### TuneMix Button

Pressing **TuneMix** puts the radio in TuneMix mode where the radio plays songs in a unique mix from the music channels you have selected for TuneMix. Pressing and holding **TuneMix** displays the TuneMix channel list where you can add or remove channels from TuneMix.



### Number Buttons

Each number button stores a favorite channel in its button location and provides one touch access to tune the channel. Number buttons also directly tune to a channel when the channel number is entered after pressing **Direct**.



## Tuning to a Channel

Press and release ▲ and ▼ to immediately tune to the next or previous channel.

Press and hold ▲ and ▼ to quickly scroll through the channels. Release to tune to the channel that is displayed.

## Direct Tune

A channel can be tuned directly by entering the channel number using the number buttons.

1. To directly tune to a channel press **Direct**.
2. Use the number buttons **0-9** to enter the channel number and wait until the channel is tuned, or press the **Select button** to immediately tune to the channel. If you make a mistake while entering the channel number, press ◀ to delete the number that was entered.

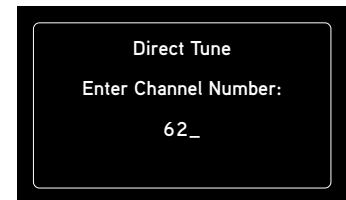

## Viewing a Category

Channels are organized into categories to make it easier for you to find channels, such as Sports, Country, Kids, Rock, etc.

In addition to the regular categories, there is special category for Favorite channels. If you have saved favorite channels, when you press ◀ from the main display screen the Favorites category is shown. Also, if you are tuned to a favorite channel, when you press ▶ the Favorites category is the first category shown.



### To view categories:

3. To view channels in a category in a list press ◀ or ▶.
4. Scroll through the channels in a category by using ▲ and ▼ to find the channel you want to tune. Press the **Select button** to tune to a highlighted channel, or press ◀ or ▶ to view channels in the previous or next category.



**TIP!** To briefly listen to each channel in the category, scroll to and highlight Scan at the end of the category list and press the **Select button**. Refer to "Scanning Channels in a Category" on page 28 to learn more about Scan.

## Scanning Channels in a Category

You can scan a category and listen to each channel for 10 seconds as Onyx EZR automatically tunes to each channel in the category. If you want to stay tuned to the channel being played and stop the scan, just press the **Select button**.

### To scan a category:

1. Press ◀ or ▶ until the desired category is displayed.
2. Scroll down and highlight the last item in the category which will be **Scan** and the category name.

3. Press the **Select button**. The scan will begin.
4. Press the **Select button** to stop the scan and to continue to listen to the channel currently being played, or press ▼ or ▲ or **menu** to return to the channel you were listening to before you began the scan.



## Automatically Tuning Channels in Categories

Onyx EZR can be configured to automatically tune channels when browsing a category list, when you highlight a channel in the list and pause for a few seconds. This feature can be turned off so that channels are not tuned automatically if desired.

### To turn channel browsing auto select on/off:

1. Press **Menu**.
2. Press ▼ to scroll to and highlight **Feature Settings**. Press the **Select button**.
3. Press ▼ to scroll to and highlight **Channel Browsing Auto Select**. Pressing the **Select button** will toggle between **On** and **Off**.
4. Press and hold **Menu** to return to the main display screen.

## Returning to the Main Display Screen

Pressing and holding **Menu** in most instances will return you to the main display screen. In some instances, you may need to follow the instructions on the display screen.

## Jump and Traffic/Weather

Depending upon how you configure the mode, pressing **Jump** will either go to the previous channel to which you were listening, or go to the traffic and weather channels. Please note that Traffic/Weather channels are not available to Canadian subscribers.

Pressing and holding **Jump** toggles the display screen between black background with white text and white background with black text.

If Jump is set to **Last Channel**, pressing **Jump** will immediately tune to the previous channel to which you were listening.

Do not set Jump for **Traffic/Weather** because Traffic/Weather channels are not available to Canadian subscribers.



**TIP!** By default **Jump** is configured to tune to the previously tuned channel.

## Favorite Channels

You can select up to 10 of your favorite channels so you can easily tune to them. Each favorite channel can be assigned to a number button.

### **To assign or replace a favorite channel to a number button:**

1. Tune to the desired channel.
2. Press and hold a number button between **0-9** that you want to assign to that favorite channel. An advisory with the channel number and name will be displayed on the screen confirming that the channel has been assigned.
3. If a favorite channel is already assigned to the number button, an advisory will be displayed prompting you to replace the favorite channel, or to cancel. Press the **Select button** to replace the favorite channel, or **Menu** to cancel the replacement.

### **To listen to a favorite channel:**

1. Press the number button between **0-9** that was assigned to the desired favorite channel. Onyx EZR will tune to the favorite channel.



**TIP!** When you are at the main display screen, press ◀ to see your list of favorite channels. Scroll to highlight a favorite channel and press the **Select button** to listen to that channel.

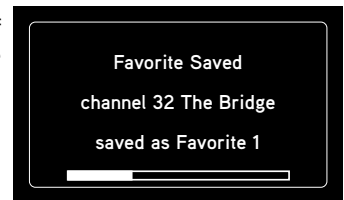

### **To erase all favorite channels:**

All favorite channels which have been previously saved can be erased all-at-once.

1. Press **Menu**.
2. Press ▼ to scroll to and highlight **Feature Settings**. Press the **Select button**.
3. Press ▼ to scroll to and highlight **Erase all Favorite Channels**. Press the **Select button**.
4. You will be prompted that all favorite channels are about to be erased. Press the **Select button** to erase all favorite channels, or **Menu** to cancel.
5. Press and hold **Menu** to return to the main display screen.

## FM Presets

FM presets make it easy to quickly access stored FM channels and choose a new FM channel from the saved presets.

FM presets are used when you use *PowerConnect* or the FMDA to listen to your Onyx EZR through your vehicle’s FM radio. (Refer to “Option 3: *PowerConnect* Installation Instructions” on page 22 for more information.)

### ***To use a different FM preset:***

1. Press **FM** to display the current FM preset.
2. To display and select the next FM preset, press **FM** again. The Radio will tune to the displayed FM channel. If the preset is the one you want, press **Menu** or wait for the screen to time out.
3. Repeatedly pressing **FM** will cycle through the FM presets.
4. Set your vehicle’s FM radio to the same FM channel.



**IMPORTANT!** You need to ensure that your vehicle’s FM radio is tuned to the same FM channel.



**TIP!** To configure the list of preset FM channels, you need to find available FM channels in your area. Refer to “Find Available FM Channels in Your Area” on page 38. Next, refer to “Set and Select an FM Channel” on page 39.



## Display Screen Mode

The display screen on the Onyx EZR can be adjusted to display a black background with white text, or a white background with black text.

### ***To switch between display modes:***

1. At the main display screen (when not in TuneMix), press and hold the **Jump** button until the display screen changes mode. Repeat to toggle between the display screen modes.

White text on a black background



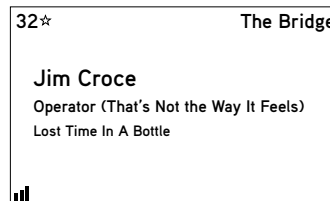

Black text on a white background



The display mode can also be adjusted through the menu settings. Refer to “Display Settings” on page 43.

## Parental Controls





Onyx EZR has a parental control feature which allows you to lock access to individual channels, or lock access to an entire category. A 4-digit lock code controls access to the locked channel or locked category.

When you browse a category, the channel number and name of the locked channel will be shown but not the artist and song/program information. Instead, a lock icon  and “Press Select to unlock channel” is shown. If you tune through the channels using  and , the locked channels are skipped and are neither displayed, nor tuned.





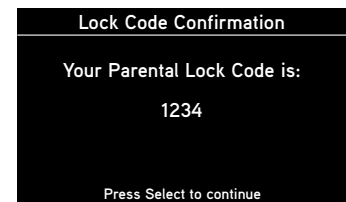
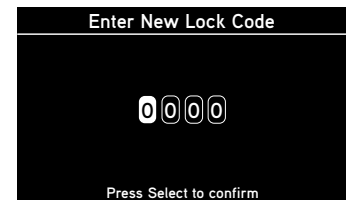

If you attempt to tune to a locked channel, either by using direct tune or through the category list, you'll be prompted to enter the 4-digit lock code. When the correct code is entered, you'll be able to tune to and listen to the channel. All locked channels become unlocked and remain unlocked until you turn Onyx EZR Off and back On. In the category list, the previously locked channels will show an unlocked icon .

### To turn Parental Controls on or off):

1. Press **Menu**.
2. Press  to scroll to and highlight **Parental Controls**. Press the **Select button**.
3. If this is the first time you are turning on Parental Controls, **Parental Controls** will be highlighted. Press the **Select button**. You will be prompted to select a 4-digit lock code:
  - i. For each digit, press one of the **0-9** keys (or press  or  to select digits and then press  to advance to the next digit.) Press  if you need to go back and edit a previous digit.
  - ii. When you have selected all 4 digits of your lock code press the **Select button**.
  - iii. The Lock Code Confirmation screen will be displayed. For your records, write down the lock code you have selected. Press the **Select button**. Continue with step 3.



If you had previously selected a 4-digit lock code you will be prompted to enter your lock code:

- i. For each digit, press one of the **0-9** keys (or press  or  to select digits and then press  to advance to the next digit.) Press  if you need to go back and edit a previous digit.
  - ii. When you have selected all 4 digits of the lock code press the **Select button**.
4. At the “Parental Controls” screen, **Parental Controls** will be highlighted. Press the **Select button** to turn parental control On (or press the **Select button** to turn parental control Off).
  5. Press and hold **Menu** to return to the main display screen.

### To lock or unlock channels or categories:

1. Press **Menu**.
2. Press  to scroll to and highlight **Parental Controls**. Press the **Select button**.



- You will be prompted to enter the 4-digit lock code. For each digit, press one of the **0-9** keys (or press ▼ or ▲ to select digits and then press ► to advance to the next digit.) Press ◀ if you need to go back and edit a previous digit.
- When you have entered all 4 digits of the lock code press the **Select button**.
- If **Parental Controls** is shown as Off, press the **Select button** to turn it On, otherwise continue with the next step.
- At the “Parental Controls” screen, press ▼ to scroll to and highlight **Locked Channels**. Press the **Select button**.
- A list of all the categories and the channels in each category will be displayed. Press ▼ and ▲ to scroll to and highlight a channel or category you want to lock. Press the **Select button**. A lock icon  will be displayed to the left of the channel or category you locked.

To unlock a locked channel or category, simply highlight the locked channel or category and press the **Select button**. The lock icon will be removed indicating the channel or category is unlocked.

- You can continue to lock and unlock as many channels or categories as you wish. When you are finished, press and hold **Menu** to return to the main display screen.

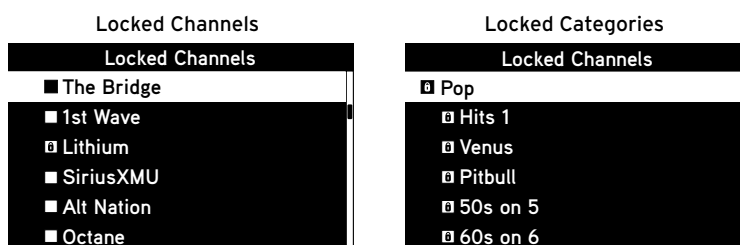

### To change your lock code:

- Press **Menu**.
- Press ▼ to scroll to and highlight **Parental Controls**. Press the **Select button**.
- You will be prompted to enter your existing 4-digit lock code. For each digit, press one of the **0-9** keys (or press ▼ or ▲ to select digits keys and then press ► to advance to the next digit.) Press ◀ if you need to go back and edit a previous digit.
- When you have entered all 4 digits of the lock code press the **Select button**.
- If **Parental Controls** are shown as Off, press the **Select button** to turn it On, otherwise continue with the next step.
- At the “Parental Controls” screen, press ▼ to scroll to and highlight **Change My Lock Code**. Press the **Select button**.
- You will be prompted to enter a new 4-digit lock code. For each digit, press one of the **0-9** (or press ▼ or ▲ to select digits keys and then press ► to advance to the next digit.) Press ◀ if you need to go back and edit a previous digit.
- The Lock Code Confirmation screen will be displayed. For your records, write down the lock code you have selected. Press the **Select button**.
- Press and hold **Menu** to return to the main display screen.

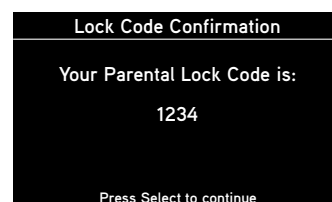

## ***To listen to a locked channel:***

There are two ways to tune to a channel which has been locked. The first is to directly tune to the locked channel using **Direct**, and the second is to select the locked channel from a category list.

1. Directly tune to or select the locked channel:

*To directly tune to a locked channel:*

- i. Press **Direct** and enter the channel number using the **0-9** keys.

*To select a locked channel from the category list:*

- i. Press ◀ or ▶ to view the category list of the locked channel to which you wish to tune.
  - ii. Press ▼ to scroll to and highlight the locked channel. Press the **Select button**.
2. You will be prompted to enter your existing 4-digit lock code. For each digit, press one of the **0-9** keys (or press ▼ or ▲ to select digits and then press ▶ to advance to the next digit.) Press ◀ if you need to go back and edit a previous digit.
  3. When you have entered all 4 digits of the lock code, press the **Select button**. If your lock code is correct the channel will be tuned. All locked channels become unlocked and will remain unlocked until you turn Onyx EZR Off and back On. In the category list, the previously locked channels will show an unlocked icon 🔒.



## TuneMix

TuneMix plays songs in a unique mix from music channels you have pre-selected, allowing you to build a blended channel from as few as three to as many as 18 music channels.

### Tips for Obtaining the Best Experience from TuneMix

Before using the TuneMix feature, familiarize yourself with the following tips to help you obtain the best experience from TuneMix:

- TuneMix plays songs which have aired on the music channels you have selected for TuneMix.
- The more music channels you select for TuneMix, the more songs TuneMix will have to play. For best results, select a minimum of three music channels.
- Certain music channels are not eligible for TuneMix due to the way in which they are broadcast. These music channels are not included in channel selection list for TuneMix.



### To add or remove channels from TuneMix:

Before you use TuneMix, add a minimum of three music channels to use for TuneMix.

1. Press and hold the **TuneMix** button (or press **Menu**, press ▼ to scroll to and highlight **Feature Settings** and press the **Select** button. **TuneMix** will be highlighted; press the **Select** button. **Edit TuneMix Channels** will be highlighted; press the **Select** button.)
2. Press ▼ or ▲ to highlight a channel in the list and press the **Select** button to add the channel for TuneMix. A selected channel will show an **X** in the box to the left of the channel name.
3. You can also add all the channels in a category by selecting the category name. When the category name is selected, all the channels in the category will be shown as selected for TuneMix.

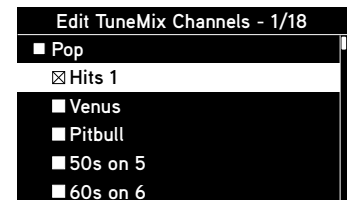

**NOTE!** if you select to add a category which has more than 18 channels, only up to the first 18 channels in the category are added to TuneMix.

4. You can also remove a channel from TuneMix by highlighting a channel already selected for TuneMix and pressing the **Select** button. The **X** in the box to the left of the channel name will be removed to indicate the channel is no longer selected for TuneMix. You can do the same for an entire category.
5. You can select up to 18 channels for TuneMix. When you have finished adding (or removing) channels, press and hold **Menu** to exit.



### To listen to TuneMix:

1. Press **TuneMix**. TuneMix will begin to play and the TuneMix icon will be displayed on in the lower right corner of the main display screen.
2. You can press ◀ or ▶ to skip back or skip ahead to the previous or next song in TuneMix.

If you have not added any channels for TuneMix, or not have not added

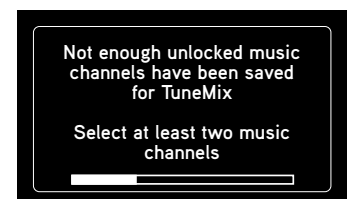

enough channels for TuneMix, or some TuneMix channels are locked by Parental Controls resulting in not enough channels for TuneMix to play, the advisory, **Not enough unlocked music channels have been saved for TuneMix** will be displayed. The TuneMix channel list will automatically be displayed so you can add channels for TuneMix, or highlight a locked channel and unlock the locked channels so they can be used in TuneMix.

### To end TuneMix:

There are two ways to end TuneMix:

- If you want to end TuneMix and continue listening to the channel that TuneMix is currently playing, press the **Select button**.
- If you want to return to the channel to which you were listening prior to TuneMix, press and hold the **Select button**.

TuneMix will terminate if you tune another channel, if you press **Jump**, if you press **TuneMix**, or if you press the **Direct** button and select a channel.

### To erase all channels from TuneMix:

Rather than removing the channels that had been previously selected for TuneMix one-by-one, you can remove all the previously selected channels at once.

1. Press **Menu**, press ▼ to scroll to and highlight **Feature Settings** and press the **Select button**.
2. **TuneMix** will be highlighted. Press the **Select button**.
3. Press ▼ to scroll to and highlight **Erase all Channels from TuneMix** and press the **Select button**.
4. You will be prompted to confirm that you want to erase all the channels that have been selected for TuneMix. Press the **Select button** to erase the channels, or press **Menu** if you do not want to erase the channels.
5. If you selected to erase all the channels, the display will show **0/18** channels selected for TuneMix indicating that no channels are currently selected for TuneMix.
6. Press and hold **Menu** to exit.

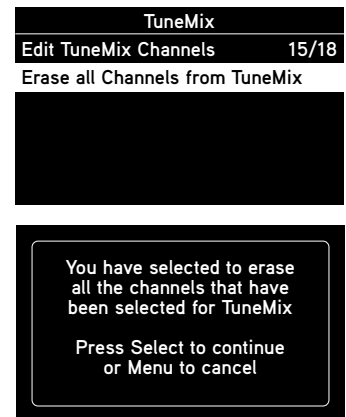

SiriusXM offers a variety of accessories that allow you to adapt your Onyx EZR to your lifestyle and enhance your listening experience. With these accessories, you can effortlessly take your Satellite Radio listening experience from your vehicle to your home or office or on the go — all with a single subscription.

**In Your Home, Office, etc. –** With a Home Kit, you can play your Onyx EZR through your existing stereo system or powered speakers.

**In Your Other Vehicles –** With Vehicle Kits, you can enjoy your Onyx EZR in other vehicles.

**In Almost Any Location You Like –** With a portable Sound System you have the freedom to listen to your Onyx EZR where and when you want, from your kitchen or den, to the office, to outside on the deck, or at a picnic.

For more information on XM accessories or to purchase an accessory, please visit your local retailer or [siriusxm.ca/shop](http://siriusxm.ca/shop).

## Radio ID

Onyx EZR has an 8 character alphanumeric ID which uniquely identifies your Radio. This ID is used during the subscription process.

### To display the Radio ID:

1. Press **Menu**.
2. **Radio ID** will be highlighted. If it is not highlighted, press ▼ to scroll to and highlight **Radio ID**. Press the **Select button**. The Radio ID will be displayed.
3. Press and hold **Menu** to return to the main display screen.

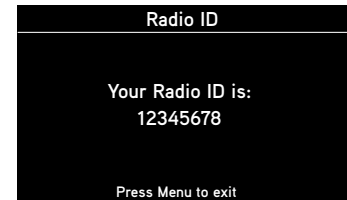

## FM Settings

### Find Available FM Channels in Your Area

Before attempting any of the procedures below, you should park your vehicle in a safe location. Do not attempt to set up your FM channels or any Onyx EZR function while driving.

*PowerConnect* allows you to listen to SiriusXM through your existing vehicle radio. You will first need to find an available FM channel, which is a channel that is not being used by an FM radio station in your area. When you tune your vehicle's FM radio to an available channel, you should only hear static or silence – not talk or music.

Once you have found an available FM channel, you'll need to tune Onyx EZR and your vehicle's radio to the same FM channel to receive XM audio through your vehicle's radio.

We recommend one of the following methods to find an available FM channel:

#### **1. Use the SiriusXM FM Channel Finder**

Use the SiriusXM FM Channel Finder at [siriusxm.ca/fm](http://siriusxm.ca/fm). Go to the website and enter your zip code. The Channel Finder will suggest a list of available FM channels in your area. For convenience, write down or print out the list.

Tune Onyx EZR to a favorite XM channel (or to channel 1, if it's not activated). Turn on your vehicle's FM radio. Pick the first FM channel on your Channel Finder list and tune the FM radio to that channel. If you do not hear a local FM station broadcast, then tune Onyx EZR to the same FM channel. (Refer to "Set and Select an FM Channel" on page 39.) You should hear the XM channel through your vehicle's radio. If you are satisfied with the sound quality, you're done! If this FM channel doesn't work well for you, work down the list until you find an FM channel that allows you to hear XM clearly.

OR

#### **2. Manually tune through your local FM channels**

Manually tune through your local FM channels on your vehicle's FM radio. Turn on your vehicle's FM radio. Start at 88.1 and use the 'Manual' tune function on your vehicle's FM radio to tune through each FM channel one-by-one (88.1 followed by 88.3 etc.) to locate channels that aren't

being used by a local FM radio station. Write down each FM channel that has only static or silence on it, until you reach 107.9. Once you have created your list of available FM channels, you will need to find the one that provides the best match for Onyx EZR.

Tune Onyx EZR to a favorite XM channel (or to channel 1, if it's not activated). Pick the first FM channel on your list and tune the FM radio to that channel. Then tune Onyx EZR to the same FM channel. (Refer to "Set and Select an FM Channel" on page 39.) You should hear the XM channel through your vehicle's radio. If you are satisfied with the sound quality, you're done! If this FM channel doesn't work well for you, work down the list until you find an FM channel that allows you to hear XM clearly.



**NOTE!** You may find an FM channel with static or silence that does not work with Onyx EZR. It is possible that some type of inaudible interference is present that prevents reception of the XM broadcast. Your only options are to use another FM channel or a different audio connection method.



**TIP!** If you regularly drive from one location to another, such as your daily commute, you may need to use different FM channels along your route for best performance. If this is the case, we recommend saving the best FM channels as presets on your FM radio and Onyx EZR. Then you simply select and match the best channel for the area you are in.



**TIP!** It will be much more difficult to find available FM channels in large cities than in most suburban or rural locations. A direct audio connection using the Aux In Cable, Cassette Adapter, or professional installation is your best solution if you drive in or near large metropolitan areas.



**NOTE!** The SiriusXM FM Channel Finder relies on data from the Federal Communications Commission. The data may not reflect the latest stations in your area. In addition, local geography and weather conditions can impact reception, so your results may be different from the list.



**NOTE!** The performance of FM radios are different, based on manufacturer and vehicle style. Some may not work well with the type of FM transmitter used by Onyx EZR. This is why we recommend a direct audio connection using the Aux In Cable or Cassette Adapter if they can be used in your vehicle. Professional installation can also resolve almost any performance issue.

## Set and Select an FM Channel

Onyx EZR allows you to easily store (i.e., preset) up to 5 different FM channels. At any time, you can select any one of these 5 FM presets to hear SiriusXM through your existing vehicle radio. Having a choice of 5 FM presets also makes it easy to switch to the appropriate FM channel as you travel from one area to another. Each FM preset is stored in its own storage location. You can easily add or edit the FM preset in any one of the 5 storage locations.



**IMPORTANT!** Onyx EZR and the vehicle's FM radio need to be tuned to the same FM channel in order to hear the audio.



**TIP!** The FM 1 storage location is preset with FM channel 97.9.

### To set and select an FM preset:

1. Press **Menu**.
2. Press ▼ to scroll to and highlight **FM Settings** and press the **Select button**.
3. **FM Channels** will be highlighted. If it is not highlighted, press ▼ to scroll to and highlight **FM Channels**. Press the **Select button**.
4. Press ▼ to scroll to and highlight the storage location (FM 1 to FM 5) you want to set and press the **Select button**. You can choose

FM Channels	
FM 1	97.9
FM 2	99.3 <span style="float: right;">current</span>
FM 3	100.3
FM 4	---
FM 5	---

among the following options:

- i. If the chosen storage location is empty (denoted by “---“), or if the storage location contains the FM preset currently being used (denoted by “current”), then the FM channel tuning screen is displayed.
- ii. If the chosen storage location has an FM preset that is not currently being used, and you want to edit it, **Edit Channel** is highlighted. Press the **Select button**. The FM channel tuning screen is displayed.
- iii. If the chosen storage location has an FM preset that is not currently being used, and you want to start using it, press ▲ to highlight **Start Using** and press the **Select button**. Skip to step 7.



5. Press ◀ and ▶ to tune to the desired FM channel in steps of .2, i.e., 99.3 to 99.5. Press ▼ and ▲ to tune to the desired channel in steps of 1, i.e., 99.3 to 100.3. Press the **Select button** to select the FM channel.
6. If you are editing the storage location that has the “current” FM preset, skip to step 7. Otherwise, **Start Using** will be highlighted. Press the **Select button**.



**NOTE!** You can also set an FM preset without having to start using it right away. Just press **Menu** and exit the screen.

7. The chosen FM channel will be confirmed on the display screen and Onyx EZR will tune to that FM channel.
8. Set your vehicle’s FM radio to same FM channel.



**IMPORTANT!** You’ll first need to find a suitable FM channel that is unused or available in your area.

### ***To quickly select an FM preset:***

1. Press **FM** to display the current FM preset.
2. To display and select the next FM preset, press **FM**. Onyx EZR will tune to the displayed FM channel. If the preset is the one you want, press **Menu** or wait for the screen to time out.
3. Repeatedly pressing **FM** will cycle through the FM presets.
4. Set your vehicle’s FM radio to same FM channel.





## Turn the FM Transmitter On/Off

Turning the FM Transmitter On applies only if you are using the older model Vehicle Dock from the Universal Xpress Car Kit, and plan to use *SureConnect* or FMDA as the audio connection option.

You'll have to turn On the FM Transmitter under the **FM Settings** menu. However, before you can access the **FM Settings** menu, you first need to disable AUX Detect. Refer to "AUX Detect" on page 46. Once you have disabled AUX Detect, the **FM Settings** menu will be accessible.

### To turn the FM Transmitter On:

1. Press **Menu**.
2. Press ▼ to scroll to and highlight **FM Settings** and press the **Select button**.
3. **FM Transmitter** will be highlighted. Press the **Select button** to toggle the setting from Off to On.
4. The **FM Channels** menu item will now be accessible, allowing you to tune Onyx EZR and the FM radio in your vehicle to the same FM channel.



**TIP!** Onyx EZR is programmed with FM channel 97.9 as the default setting.

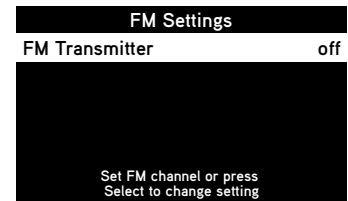

### To turn the FM Transmitter Off:

If you are using the older model Vehicle Dock from the Universal Xpress Car Kit, and plan to use the Aux In Cable or a Cassette Adapter as the audio connection option, you'll have to turn the FM Transmitter under the **FM Settings** menu in Onyx EZR Off, if it was previously turned On.

1. Press **Menu**.
2. Press ▼ to scroll to and highlight **FM Settings** and press the **Select button**.
3. **FM Transmitter** will be highlighted. Press the **Select button** to toggle the setting from On to Off.
4. A warning message will be displayed advising you to connect the Aux In Cable. Press the **Select button** to confirm that you want to turn off the FM Transmitter.
5. Press and hold **Menu** to exit.

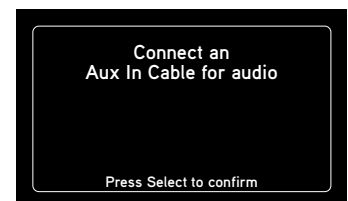

## Jump Settings

The **Jump** button can be configured to jump back to the last channel to which you were listening to previous to the currently tuned channel (default), or jump to the traffic and weather for the city of your choice from a list of cities. Please note that Traffic/Weather channels are not available to Canadian subscribers, so Jump Settings should always remain set to **Last Channel** (the default setting).

### To configure Jump:

1. Press **Menu**.
2. Press ▼ to scroll to and highlight **Jump Settings** and press the **Select button**.
3. **Mode** will be highlighted with either **Last Channel** or **Traffic/Weather**. If you want to change the mode, press the **Select button**. Otherwise, just leave it as shown. (Repeatedly pressing the **Select button** toggles between the choices.)
4. If you have selected **Last Channel**, press and hold **Menu** to return to the main display screen.

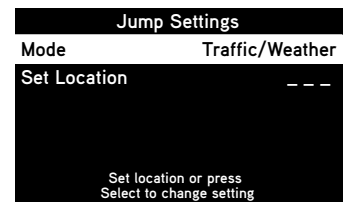
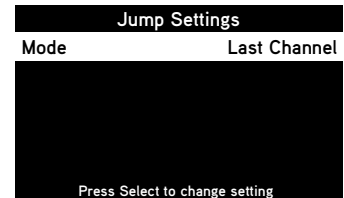

Please note that Traffic/Weather channels are not available to Canadian subscribers. Jump Settings should always remain set to **Last Channel** (the default setting).

## Display Settings

Display Settings allows you to change the mode of the display screen, to adjust the brightness of the display screen, and adjust the brightness of the buttons of Onyx EZR.

### Display Screen

1. Press **Menu**.
2. Press ▼ to scroll to and highlight **Display Settings** and press the **Select button**.
3. **Display Screen** will be highlighted. Press the **Select button** to toggle the display screen between white/black and black/white.
4. Press and hold **Menu** to return to the main display screen.

White text on a black background

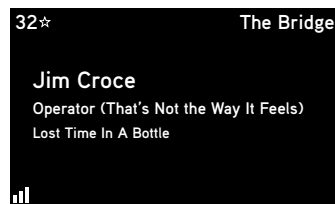

Black text on a white background

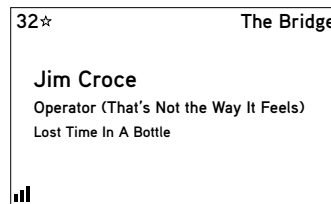

**TIP!** You can also change the display screen mode by pressing and holding the **Jump** button.

### Screen Brightness

1. Press **Menu**.
2. Press ▼ to scroll to and highlight **Display Settings** and press the **Select button**.
3. Press ▼ to scroll to and highlight **Screen Brightness** and press the **Select button**.
4. Press ◀ to decrease or ▶ to increase the brightness of the display.
5. Press the **Select button** to confirm the brightness setting.
6. Press and hold **Menu** to return to the main display screen.

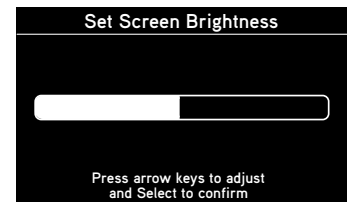

### Button Brightness

1. Press **Menu**.
2. Press ▼ to scroll to and highlight **Display Settings** and press the **Select button**.
3. Press ▼ to scroll to and highlight **Button Brightness** and press the **Select button**.
4. Press ◀ to decrease or ▶ to increase the brightness of the buttons.
5. Press the **Select button** to confirm the brightness setting.
6. Press and hold **Menu** to return to the main display screen.



## Feature Settings

Feature Settings allows you to adjust TuneMix, set the audible beep on/off, set the channel browsing auto select on/off, set text scrolling on/off, and erase all favorite channels.

### TuneMix

Refer to “TuneMix” on page 35 for detailed information.

### Audible Beep

Audible Beep turns on or off the beep that is heard when an advisory screen is displayed, or a traffic/weather report is tuned, etc.

1. Press **Menu**.
2. Press ▼ to scroll to and highlight **Feature Settings** and press the **Select button**.
3. Press ▼ to scroll to and highlight **Audible Beep**. Pressing the **Select button** will toggle between **On** and **Off**.
4. Press and hold **Menu** to return to the main display screen.

### Channel Browsing Auto Select

Refer to “Automatically Tuning Channels in Categories” on page 29 for detailed information.

### Text Scrolling

When an artist’s name or a song title is too long to be completely displayed on the display screen, the artist name and/or song title will scroll after a few seconds. This feature can be turned on or off as desired.

1. Press **Menu**.
2. Press ▼ to scroll to and highlight **Feature Settings** and press the **Select button**.
3. Press ▼ to scroll to and highlight **Text Scrolling**. Pressing the **Select button** will toggle between **On** and **Off**.
4. Press and hold **Menu** to return to the main display screen.

### Erase all Favorite Channels

Refer to “Favorite Channels” on page 30 for detailed information.

## Audio Level

The audio level of Onyx EZR can be adjusted when an audio connection is made between the dock and the vehicle's stereo system. Audio level is used to adjust Onyx EZR's volume level to match the volume of other audio sources you may use, such as a CD player, other FM stations, or an MP3 player.

Do not use the audio level as a volume control. Use the volume control on your vehicle's stereo instead.

### To adjust the audio level:

1. Press **Menu**.
2. Press ▼ to scroll to and highlight **Audio Level** and press the **Select button**.
3. Press ◀ to decrease or ▶ to increase the audio level.
4. Press the **Select button** to confirm the new audio level.
5. Press and hold **Menu** to return to the main display screen.

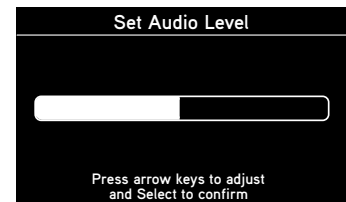

## Parental Controls

Refer to “Parental Controls” on page 32 for detailed information.

## Signal Indicator

For best reception, your Magnetic Mount Antenna should have an unobstructed view of the XM satellites. In large cities, there are terrestrial transmitters (ground repeaters) to help increase the signal coverage.

Your Onyx EZR can display the received strength of the satellite and terrestrial signals being received.

### To display the signal strength:

1. Press **Menu**.
2. Press ▼ to scroll to and highlight **Signal Indicator** and press the **Select button**.
3. The Satellite and Terrestrial bars show the strength of the signal being received.
4. Reposition the antenna if you are having trouble receiving the signal. Be sure your vehicle is outside with an unobstructed view of the sky.
5. Press and hold **Menu** to return to the main display screen.

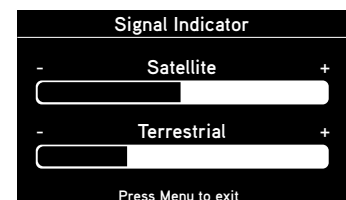

## Auto Shut Off

Onyx EZR will automatically shut off after 8 hours of inactivity, i.e., when no buttons have been pressed. This feature prevents the vehicle battery from being discharged if you forget to turn your Onyx EZR off.

When Onyx EZR is about to shut off, an advisory will be displayed. If you wish to continue listening, press any button to cancel the auto shut off.

### To enable or disable Auto Shut Off:

1. Press **Menu**.
2. Press ▼ to scroll to and highlight **Auto Shut Off** and press the **Select button**.
3. **Status** will be highlighted. Press the **Select button** to toggle between enabled or disabled for Auto Shut Off.
4. Press and hold **Menu** to return to the main display screen.

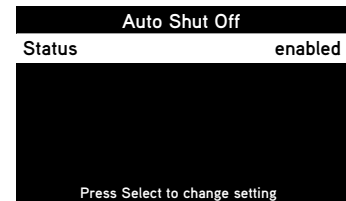

## Factory Settings

The factory settings menu has two choices, **AUX Detect** and **Restore Defaults**.

### AUX Detect

AUX Detect allows Onyx EZR to automatically detect a connection made to the **AUDIO** connector of the *PowerConnect* Vehicle Dock by an Aux In Cable or Cassette Adapter. AUX Detect is enabled by default.



**IMPORTANT!** If you are using the *PowerConnect* Vehicle Dock which came with your Onyx EZR, AUX Detect should remain enabled.

If you are using the older model Vehicle Dock from the Universal Xpress Car Kit, and plan to use *PowerConnect* or FM/DA as the audio connection option, you will need to disable AUX Detect. Once AUX Detect is disabled, you'll have to turn the FM Transmitter On. Refer to "Turn the FM Transmitter On/Off" on page 41.

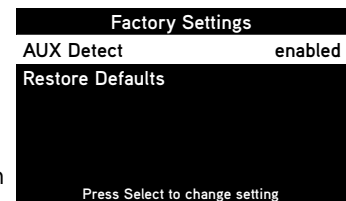

### To disable AUX Detect:

Do this only when using the older model Vehicle Dock.

1. Press **Menu**.
2. Press ▼ to scroll to and highlight **Factory Settings** and press the **Select button**.
3. **AUX Detect** should be highlighted and show as enabled. Press the **Select button** to toggle the setting.
4. An advisory screen will be displayed. Press the **Select button** to confirm that you want to disable AUX Detect, otherwise press **Menu**

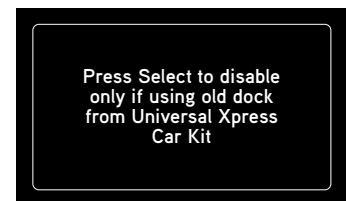

to cancel.

5. If you want to cancel press **Menu** to return to **Factory Settings**. AUX Detect will remain enabled.
6. AUX Detect will show as disabled. Press and hold **Menu** to return to the main display screen.

### **To enable AUX Detect:**

Do this when the Radio is transferred to the *PowerConnect* Vehicle Dock from an older model Vehicle Dock.

1. Press **Menu**.
2. Press ▼ to scroll to and highlight **Factory Settings** and press the **Select button**.
3. **AUX Detect** will be highlighted and show as disabled. Press the **Select button** again to toggle the setting to enabled.
4. Press and hold **Menu** to return to the main display screen.

## Restore Defaults

You can clear all of your personal settings, such as favorite channels, FM presets, etc., and return the Radio to its original out-of-the-box settings.

### **To reset Onyx EZR to factory defaults:**



**NOTE!** Restoring defaults permanently removes all personal settings.

1. Press **Menu**.
2. Press ▼ to scroll to and highlight **Factory Settings** and press the **Select button**.
3. Press ▼ to scroll to and highlight **Restore Defaults** and press the **Select button**.
4. An advisory screen will be displayed. If you are certain that you want to reset your Onyx EZR to the default settings, press the **Select button** to confirm.
5. If you want to cancel, press **Menu** to return to **Factory Settings**.



## Demo Mode

Your Onyx EZR has a demo mode that starts playing when, for a prolonged period of time (more than 5 minutes), the Radio either detects it's not connected to the antenna, or the antenna stops receiving a signal. It disappears when the antenna is connected properly or when the Radio starts receiving a signal. You can also exit demo mode at any time, by pressing and holding the **Select button** for 10 seconds. If desired, you can also manually put Onyx EZR in demo mode.

The ability for Onyx EZR to enter demo mode is enabled by default. If you don't want Onyx EZR to ever enter the demo mode, you can disable the demo feature. You can enable it again at another time if desired.

**To enable or disable the demo mode:**

1. Press **Menu**.
2. Press ▼ to scroll to and highlight **Demo Mode** and press the **Select button**.
3. **Status** will be highlighted. Press the **Select button** to toggle the setting between enabled or disabled. (Repeatedly pressing the **Select button** toggles between the choices.)
4. If you have selected disabled, press and hold **Menu** to return to the main display screen. If you have selected enabled continue with step 5.
5. Press ▼ to scroll to and highlight **Enter Demo Mode** and press the **Select button**. The demo mode will start in 10 seconds.
6. To exit demo mode at any time, press and hold the **Select button** for 10 seconds.

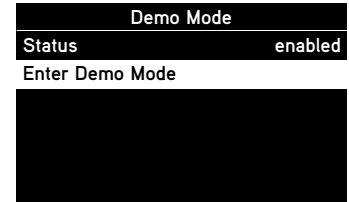



Onyx EZR has been designed and built to be trouble-free but if you experience a problem, try this:

- Check that all connections are firm and secure.
- Make sure the vehicle power socket is clean and free of corrosion.
- Make sure you have connected Onyx EZR as described in this User Guide. Verify that the *PowerConnect* Power Adapter is plugged into the vehicle’s cigarette lighter or power adapter socket, and that the LED on the *PowerConnect* Power Adapter is lit (on). If not, your vehicle may need to be running to provide power to the socket.

If you see this on the screen:	Try this:
Acquiring Signal	<ul style="list-style-type: none"> <li>• Make sure that the vehicle is outdoors with a clear view of the sky.</li> <li>• Make sure the Magnetic Mount Antenna is mounted outside of the vehicle.</li> <li>• Move the antenna away from any obstructed area. For example, if you are parked in an underground garage, you should receive a signal after leaving the garage.</li> </ul>
Check Antenna Connection	<ul style="list-style-type: none"> <li>• Make sure that the antenna cable is firmly and securely plugged into the <i>PowerConnect</i> Vehicle Dock. Make sure the cable is not bent or broken.</li> <li>• Turn Onyx EZR Off, then On, to reset this message.</li> <li>• If the message persists, most likely the Magnetic Mount Antenna cable has been damaged. Replace the antenna.</li> </ul>
Channel Off Air	<ul style="list-style-type: none"> <li>• The channel you’ve selected is not currently broadcasting. Tune to another channel.</li> </ul>
Loading	<ul style="list-style-type: none"> <li>• Your Onyx EZR is acquiring audio or program information This message usually goes away in a few seconds.</li> </ul>
Updating	<ul style="list-style-type: none"> <li>• Your Onyx EZR is updating with the latest encryption code. Wait until the update is done.</li> <li>• You may be trying to tune to a channel that is blocked or unavailable. Tune to another channel.</li> </ul>
—	<ul style="list-style-type: none"> <li>• No program information, such as artist name, song title, or channel exists.</li> </ul>
If this happens:	Try this:
You do not receive all the channels to which you subscribed	<ul style="list-style-type: none"> <li>• Ensure that you have subscribed to the service by following the steps in “Activation” on page 24.</li> <li>• Go to <a href="http://siriusxm.ca/refresh">siriusxm.ca/refresh</a> and follow the directions to refresh your Radio.</li> <li>• Call 1-888-539-7474 for further assistance.</li> </ul>
Audio sounds too soft	<ul style="list-style-type: none"> <li>• Raise the volume of your stereo system or increase the audio level of your Onyx EZR until the sound quality improves. Refer to “Audio Level” on page 45.</li> </ul>

If this happens:	Try this:
Audio fades or has static when listening	<ul style="list-style-type: none"> <li>• Check all cables for a firm and secure connection.</li> <li>• If you are using <i>PowerConnect</i> to listen via your vehicle's FM radio, and the problem persists, it most likely is interference from another commercial or broadcast FM station. You will need to find an unused or available FM channel in your area. Refer to "Find Available FM Channels in Your Area" on page 38.</li> <li>• If you are using <i>PowerConnect</i>, and you cannot solve the audio problem, try connecting the audio using the Aux In Cable or a Cassette Adapter. (Refer to page 20 and page 21.) If you cannot use those solutions, consider using an FM Direct Adapter. (Refer to page 23.)</li> </ul>
No audio when using <i>PowerConnect</i> or FMDA	<ul style="list-style-type: none"> <li>• Check that your Onyx EZR and your vehicle's FM radio are tuned to the same FM channel.</li> <li>• For <i>PowerConnect</i>, ensure you are using the <i>PowerConnect</i> Vehicle Dock and <i>PowerConnect</i> Power Adapter.</li> <li>• If you are using the Vehicle Dock that came with the Universal Xpress Car Kit, ensure that the FM Transmitter in Onyx EZR is turned On.</li> </ul>
No song title or artist name is displayed	<ul style="list-style-type: none"> <li>• The information may not be available or updates may be in progress.</li> </ul>
Traffic and Weather channels sound different from other channels	<ul style="list-style-type: none"> <li>• Traffic/Weather channels are not available to Canadian subscribers.</li> </ul>
The demo is playing	<ul style="list-style-type: none"> <li>• Your Magnetic Mount Antenna is not connected or you are not receiving the signal. Check that the antenna is connected properly and is not obstructed.</li> <li>• Press and hold the <b>Select button</b> for 10 seconds to exit Demo Mode.</li> <li>• You can disable Demo Mode. Refer to "Demo Mode" on page 47.</li> </ul>



## **Patent Information**

It is prohibited to, and you agree that you will not, copy, decompile, disassemble, reverse engineer, hack, manipulate, or otherwise access and/or make available any technology incorporated in this product. Furthermore, the AMBE® voice compression software included in this product is protected by intellectual property rights including patent rights, copyrights, and trade secrets of Digital Voice Systems, Inc. The software is licensed solely for use within this product. The music, talk, news, entertainment, data, and other content on the Services are protected by copyright and other intellectual property laws and all ownership rights remain with the respective content and data service providers. You are prohibited from any export of the content and/or data (or derivative thereof ) except in compliance with applicable export laws, rules and regulations. The user of this or any other software contained in a Sirius XM Radio Inc is explicitly prohibited from attempting to copy, decompile, reverse engineer, hack, manipulate or disassemble the object code, or in any other way convert the object code into human-readable form.

## **Environmental Information**

Follow local guidelines for waste disposal when discarding packaging and electronic appliances.

**Canadian Compliance:** This Class B digital apparatus complies with Canadian CAN ICES-3 (B)/NMB-3(B). This device complies with Industry Canada license-exempt RSS standard(s). Operation is subject to the following two conditions:

1. This device may not cause harmful interference.
2. This device must accept any interference received, including interference that may cause undesired operation.

For product available in the Canada market, only channel 1-11 can be operated. Selection of other channels is not possible. This device and its antenna(s) must not be co-located or operation in conjunction with any other antenna or transmitter. To reduce potential radio interference to other users, the antenna type and its gain should be so chosen that the equivalent isotropically radiated power (e.i.r.p) is not more than that permitted for successful communication. IC Radiation Exposure Statement: This equipment complies with IC RSS-102 radiation exposure limits set forth for an uncontrolled environment. This equipment should be installed and operated with minimum distance 20cm between the radiator & your body.

**WARNING!** The FCC and FAA have not certified this Satellite Radio Receiver for use in any aircraft (neither portable nor permanent installation). Therefore, SiriusXM cannot support this type of application or installation.

## **IMPORTANT NOTICE: REQUIRED SUBSCRIPTION**

Hardware and subscription sold separately, and activation fee required. Other fees and taxes may apply. **Subscriptions governed by SiriusXM Customer Agreement; see [siriusxm.ca](http://siriusxm.ca). Service automatically renews into the subscription Package you choose (which may differ from the Package which arrived with the Radio), for additional periods of the same length, and automatically bills at then-current rates, after any complimentary trial or promotional period ends. You must call us to cancel at 1-888-539-7474.** Fees and programming are subject to change.

© 2018 Sirius XM Canada Inc. "SiriusXM", the SiriusXM logo, channel names and logos are trademarks of Sirius XM Radio Inc. and are used under license. "NFL" and the NFL Shield design are trademarks of the National Football League. NASCAR® is a registered trademark of the National Association for Stock Car Auto Racing, Inc. The NBA and NBA member team identifications are the intellectual property of NBA Properties, Inc. and the respective NBA member teams. © 2018 NBA Properties, Inc. All rights reserved. NHL and the NHL Shield are registered trademarks of the National Hockey League. © NHL 2018. Elvis Radio logo © EPE Reg. U.S. Pat & TM off. CFL® is a registered trademark of the Canadian Football League. All other trademarks, service marks, images and logos are property of their respective owners and are used with permission. All Rights Reserved. Required subscription sold separately. Pricing and programming is subject to change. Premier subscription required for some channels. See Customer Agreement for complete terms at [siriusxm.ca](http://siriusxm.ca).

The Radio model number is located below and the XM Radio ID is located on the label on the back of Onyx EZR.

Record the XM Radio ID in the space provided below. Refer to these numbers whenever you call your dealer regarding this product.

Radio Model Number: SXEZR1V1

XM Radio ID: \_\_\_\_\_

**Sirius XM Canada Inc.  
135 Liberty St. - 4th floor  
Toronto, Ontario, M6K 1A7  
1-888-539-7474**

**[siriusxm.ca](http://siriusxm.ca)**