



User Guide

**Onyx
Radio & Vehicle Kit**

Table of Contents

Introduction	5	Colour Themes	64
Features	6	Parental Controls	65
Safety and Care Information	7	Configuring Your Onyx	71
What's in the Box?	9	Radio ID	72
Onyx Functions	10	Find Available FM Channels in Your Area	73
PowerConnect Vehicle Dock	11	Set and Select an FM Channel	75
Vehicle Installation	13	Set Brightness	79
Step 1: Choose a Location for Your Radio	14	Set Audio Level	80
Step 2: Install the Dash or Vent Mount . 16		Signal Indicator	81
Step 3: Mount the Magnetic Mount Antenna	20	Factory Settings	82
Step 4: Route the Magnetic Mount Antenna Cable	25	Demo Mode	85
Step 5: Connect the Magnetic Mount Antenna and PowerConnect Power Adapter	37	Using the Vehicle Dock From the Universal Xpress Car Kit	87
Step 6: Connect the Audio	38	Turn FM Transmitter On/Off	88
Activation	49	Troubleshooting	91
Using Your Onyx	51	Product Specifications	97
The Main Display	52	Patent Information	99
Navigation Basics	53	Environmental Information	99
Listening to Satellite Radio	55	Owner's Record	102
FM Presets	60		
Special Features	63		

Introduction

Features

Congratulations on your purchase of the Onyx!

The Onyx has these exciting features to enhance your overall experience:

- **Large color display:** View artist name, song title, and channel information on a colour display.
- **Customize your display:** Choose the backlight colour theme that matches your mood or your vehicle dash lights.
- **Enhanced real-time channel guide:** Browse programs, artists, and songs playing on other channels, without having to change the channel you are on.
- **Favourite channel presets:** Save and enjoy fast access to up to 10 of your favourite channels.
- **FM preset button:** Store and quickly access FM channels that give you the best audio reception when using *PowerConnect*.
- **Parental controls:** Easily lock and unlock channels with mature content.

Please read the entire user guide before using your Onyx!

Safety and Care Information



IMPORTANT! Always read and understand all the instructions to avoid injury to yourself and/or damage to your device. XM Radio Inc. disclaims all responsibility for damage from data loss due to breakdown, repair, or other causes.

- Do not expose to extreme temperatures (above 60°C or below -20°C, or above 140°F or below -4°F).
- Do not expose to moisture. Do not use device near or in water.
- Do not let any foreign matter spill into device.
- Do not store in dusty areas.
- Do not expose to chemicals such as benzene and thinners. Do not use liquid or aerosol cleaners. Clean with a soft damp cloth only.
- Do not expose to direct sunlight for a prolonged period of time, and do not expose to fire, flame, or other heat sources.
- Do not try to disassemble and/or repair device yourself.
- Do not drop your device or subject it to severe impact.
- Do not place heavy objects on device.
- Do not subject device to excessive pressure.
- If the LCD screen is damaged, do not touch the liquid crystal fluid.

Introduction

Warning!

- Opening the case may result in electric shock.
- If the liquid crystal fluid comes in contact with your skin, wipe the skin area with a cloth and then wash the skin thoroughly with soap and running water. If the liquid crystal fluid comes into contact with your eyes, flush the eyes with clean water for at least 15 minutes and seek medical care. If the liquid crystal fluid is ingested, flush your mouth thoroughly with water. Drink large quantities of water, and induce vomiting. Seek medical care.
- Make sure that you insert the *PowerConnect* Power Adapter all the way into the vehicle's cigarette lighter or power adapter socket.
- Do not insert several devices into the same power socket.
- Use the *PowerConnect* Power Adapter and Vehicle Dock away from water sources to avoid fire or electric shock.
- Do not touch the device with wet hands.
- When using this product, it is always important to keep your eyes on the road and hands on the wheel. Not doing so could result in personal injury, death, and/or damage to your device, accessories, and/or to your vehicle or other property.
- Vehicle installation and radio configuration functions should not be performed while driving. Park your vehicle in a safe location before beginning installation.

Your device should be placed in your vehicle where it will not interfere with the function of safety features, e.g., deployment of airbags. Failure to correctly place device may result in injury to you or others, if the unit becomes detached during an accident and/or obstructs the deployment of an airbag.

What's in the Box?

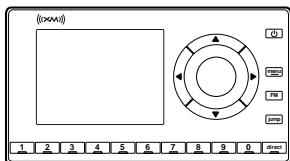

Onyx Radio

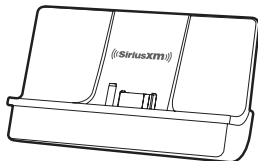

PowerConnect Vehicle Dock

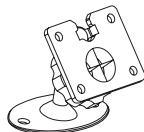

Dash Mount



Aux In Cable

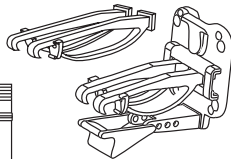

Vent Mount
and Extended
Vent Clamps



Screws (4)

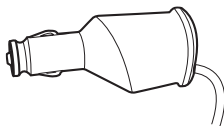

PowerConnect Power
Adapter

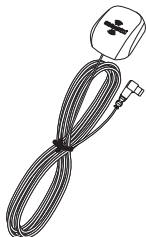

Magnetic Mount
Antenna



Antenna & Dash Mount
Alcohol Preparation Pads

Introduction

Onyx Functions

Up and Down Arrows
Scroll through lists and preview channels; also highlight menu options.

Left and Right Arrows
Search for channels by category.

Power Button
Turn radio on and off.

Select Button
Press to confirm selection for channel and menu items.

Menu Button
Access advanced features and configuration options; also press and hold to return to main display screen.

FM Button
Access and cycle through FM presets.

Jump
Jump back to the previous channel to which you were listening.

Number Buttons
Select your favourite channels; also enter a channel number.

Direct Button
Press first before entering the channel number, to directly tune to a channel.

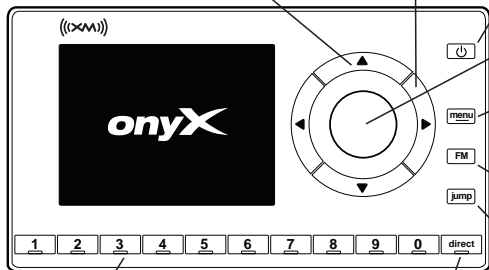

PowerConnect Vehicle Dock

Colour-Coded Connections

The *PowerConnect* Vehicle Dock has colour-coded connectors to assist you in connecting the cables to the correct connector.

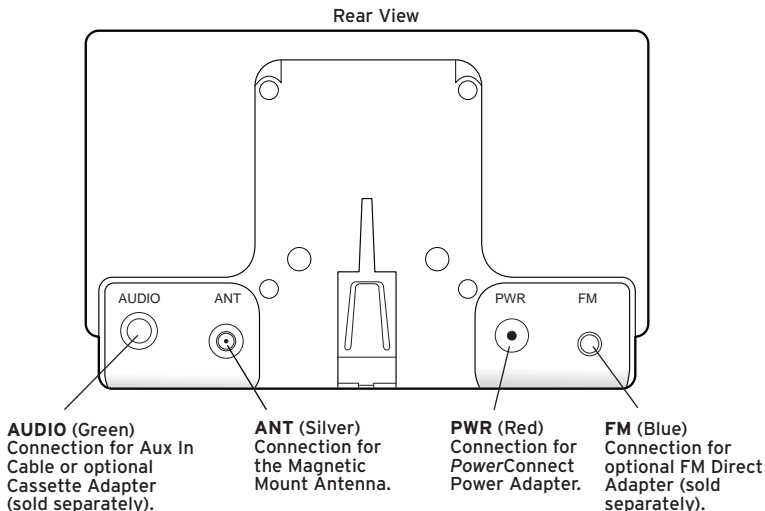

Introduction

Wire Guide

The *PowerConnect* Vehicle Dock has a wire guide at the top rear that can help you to organize the cables and wires connected to the dock. If you need to bring a cable or wire from one side of the dock to the other, utilize the wire guide by looping the cable through the wire guide as shown.

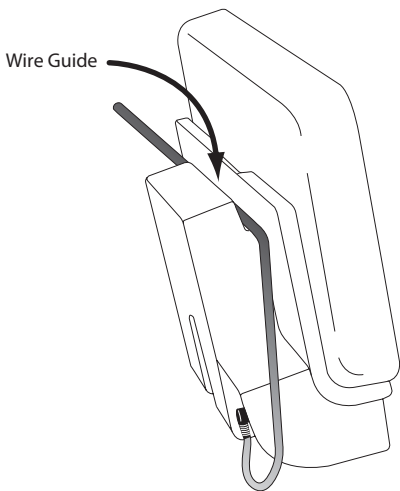

Vehicle Installation

Vehicle Installation

Step 1: Choose a Location for Your Radio

When installing the Onyx in your vehicle, choose a location where it will not block your vision, interfere with the controls, or obstruct the air bag. The location should be easily accessible and provide good visibility of the display, and should not be located where it will be in direct sunlight, which will affect the visibility of the the display screen.

Several examples of the Onyx mounted in a vehicle are shown: **A** is the on dash method using the Dash Mount, and **B** is the vent clip method using the Vent Mount.

Option 1

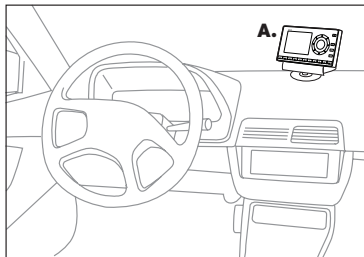

Option 2

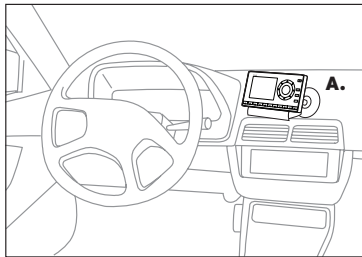

Option 3

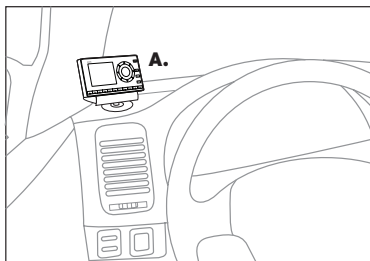

Option 4

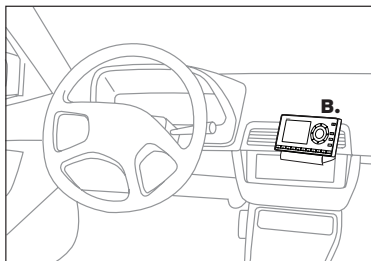

Option 5

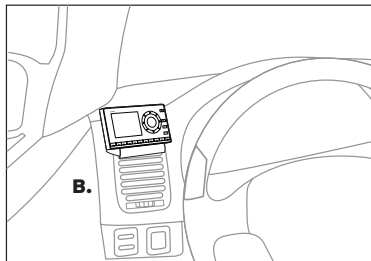

Vehicle Installation

Step 2: Install the Dash or Vent Mount

Follow the instructions on the next several pages for the mounting method you have selected.



NOTE! The *PowerConnect* Vehicle Dock included with Onyx is compatible with the T-slot style Dash and Vent Mounts. If you have an existing Dash Mount or Vent Mount in your vehicle, you can continue to use it with this dock, and skip this step.

Installing the Dash Mount:



CAUTION! The adhesive used on the Dash Mount may be difficult to remove. Do not install this mount on leather surfaces (contact your automobile dealership if you are unsure about your dash surface), and make sure the air temperature is at least 60°F (15°C) during installation. If it's not at least 60°F, turn on the heater in your vehicle to bring the temperature up to 60°F.

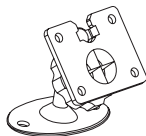

1. Locate a flat surface for the Dash Mount. Make sure there is ample room for the *PowerConnect* Vehicle Dock and Onyx Radio when installed.
2. Set the orientation of the Dash Mount before adhering it. Loosen the knob and adjust the adhesive foot for the location you selected in "Step 1: Choose a Location for Your Radio" on page 11.

- Option 1 & Option 3 should be oriented as **I**.
- Option 2 should be oriented as **II**.

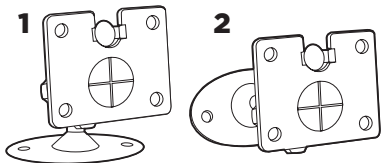

3. The dock mounting plate can be tilted in different directions. Adjust as necessary for your particular

vehicle. When the orientation is correct, tighten the knob.

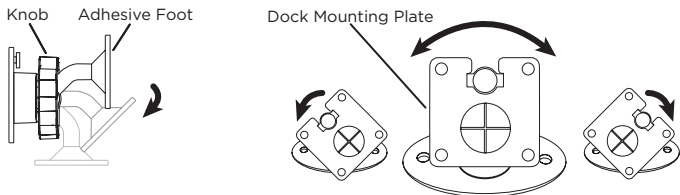

4. Attach the Dash Mount to the *PowerConnect Vehicle Dock* using the 4 provided screws.
5. Before you attach the Dash Mount to the dash, skip ahead and finish the remainder of the vehicle installation so that the cables are attached to the dock.
6. Once the cables have been attached to the dock, clean the mounting surface in the vehicle with the alcohol preparation pad and let it dry thoroughly.
7. Peel off the adhesive liner. Position, press, and hold the Dash Mount in place for 30 seconds.

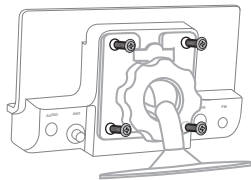

IMPORTANT! Allow the Dash Mount adhesive to cure (dry) for a minimum of 2-4 hours before using the mount. The best adhesion occurs after 24 hours.



TIP! To remove the Dash Mount, carefully lift the adhesive pad with your fingers or a spoon. Warming the pad with a hair dryer for several minutes will help soften the adhesive.

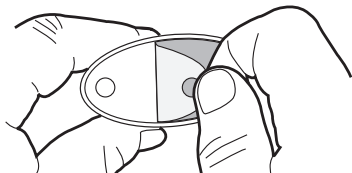

Vehicle Installation

Installing the Vent Mount:



IMPORTANT! To make the cable connections easier, wait until after you have connected all the cables to the dock before you attach the Vent Mount to a vent.

1. Locate a vent with horizontal louvers sturdy enough to hold your *PowerConnect* Vehicle Dock and Onyx Radio.
2. If the vent louvers in your vehicle are recessed, you may need to use the longer vent clamps with the Vent Mount. If so, remove the shorter vent clamps and install the longer ones into the Vent Mount. Be sure to observe the orientation of the vent clamps as shown.

Extended Vent Clamps

Short Vent Clamps

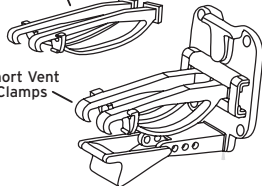

Remove End Cap

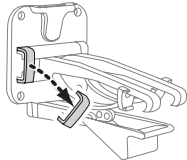

Slide Short Vent Clamps Out

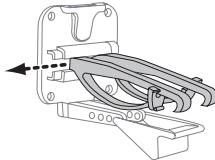

Slide Extended Vent Clamps In

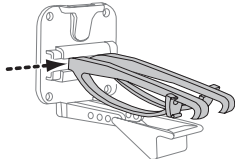

Replace End Cap

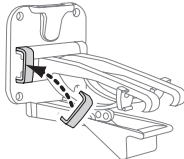

3. Attach the Vent Mount to the PowerConnect Vehicle Dock using the 4 provided screws.
4. Before you attach the Vent Mount to the vent, skip ahead and finish the remainder of the vehicle installation so that the cables are attached to the dock.

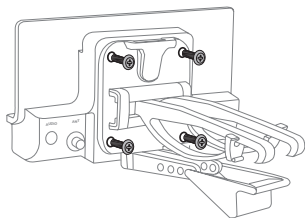

Note! For greater clarity, the next illustration does not show the dock attached to the Vent Mount, however, the dock should be attached before continuing.

5. Once the cables have been attached to the dock, push the Vent Mount onto the vehicle vent as shown (1) until it hooks on the rear of the vent louver (2).

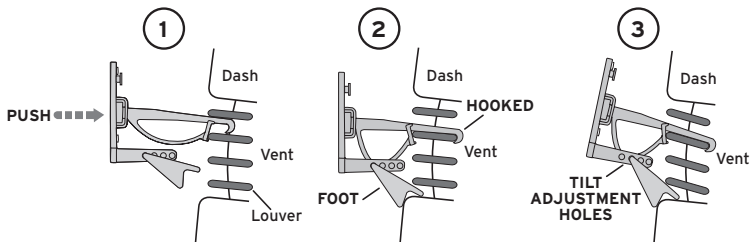

6. Rest the foot against the bottom of the vent (2), and adjust the tilt of the Vent Mount by repositioning the foot to a different adjustment hole (3).



TIP! To remove the Vent Mount, push the mount into the vent. Then lift up until disengaged from the rear of the vent louver, and remove the Vent Mount.

Vehicle Installation

Step 3: Mount the Magnetic Mount Antenna

The Magnetic Mount Antenna contains a strong magnet which will stick to any metal part of your vehicle, but will not damage the vehicle.

To install the Magnetic Mount Antenna:

1. Choose the best location for your antenna considering your vehicle type. Pay particular attention to any accessories that you may have like luggage racks and how frequently you may use them.



Sedan/Coupe: We recommend mounting the antenna just above either the front windshield or the back window as shown.

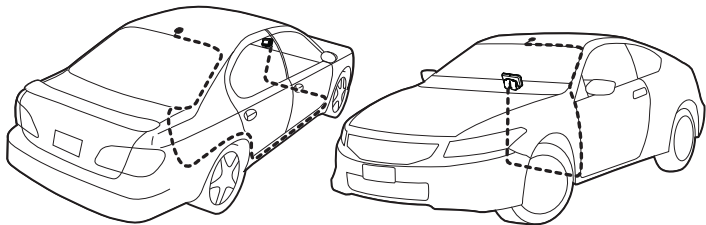

SUV: We recommend mounting the antenna at the rear of the roof as shown.

Convertible: We recommend mounting the antenna at the leading edge of the trunk as shown.

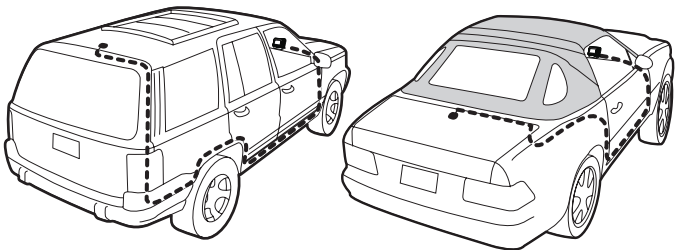

Pickup Truck: We recommend mounting the antenna just above the front windshield as shown.

2. Clean the surface of the selected mounting location using the alcohol preparation pad and let it dry thoroughly.

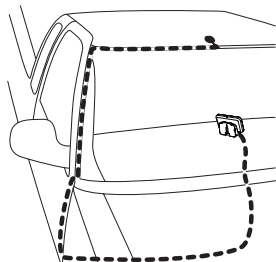

Vehicle Installation

3. Place the antenna in the location you selected. Follow the Tips and Cautions shown on the next several pages.

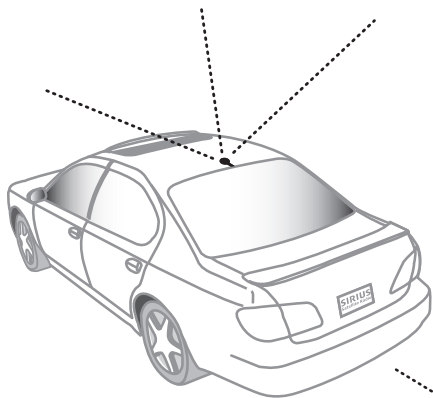

TIP! Mount the antenna on the roof (for most vehicles) or trunk (for convertibles) where it has a clear view of the sky in all directions.

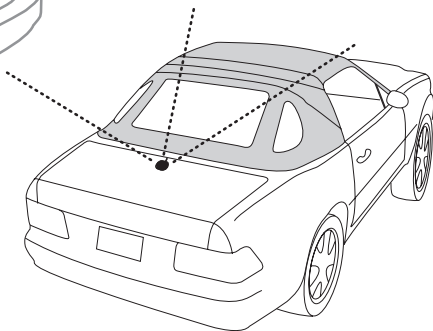



CAUTION! Don't mount the antenna inside the vehicle, for example, on the dashboard.

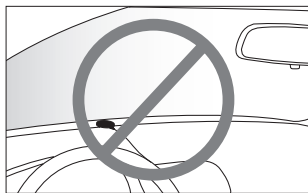

CAUTION! Don't mount the antenna on any of the vehicle's front, back or side pillars.

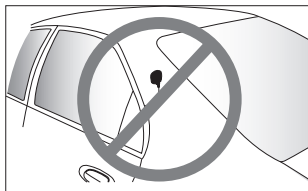

CAUTION! Don't mount the antenna close to a roof rack. Adjust the rack so it's further away from the antenna or move the antenna closer to the center of the roof.

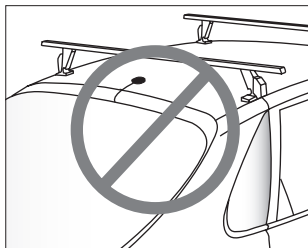

Vehicle Installation



CAUTION! Don't mount the antenna close to another antenna. Mount it at least 7.5 cm (3 inches) away.

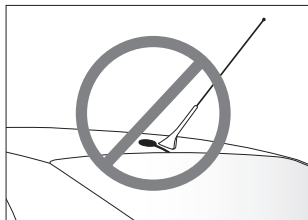

Step 4: Route the Magnetic Mount Antenna Cable

Before you begin routing the antenna cable, read these general instructions for how to route and hide the antenna cable. Then route your antenna cable according to the instructions which follow for your specific type of vehicle.

Use a blunt plastic putty knife, a credit card, a plastic knife, or a similar blunt tool to lift the rubber window moulding

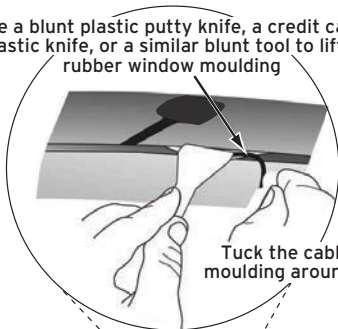

Tuck the cable under the moulding around the window

Feed cable under rubber moulding around window

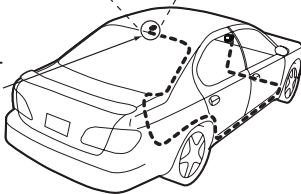

Vehicle Installation

Route cable out from under rear windshield moulding and tuck into weatherstripping around trunk opening
Avoid sharp bends by running cable through weatherstripping for several inches

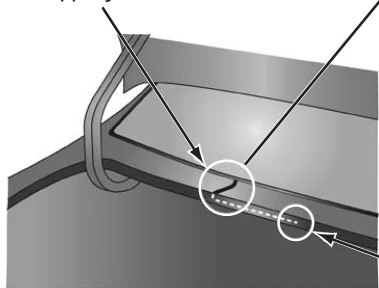

Pull weatherstripping from trunk opening

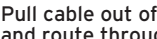

Tuck cable into weatherstripping. Route cable through weatherstripping several inches to avoid sharp bends

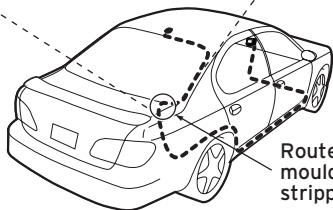
Pull cable out of weatherstripping and route through trunk to cabin

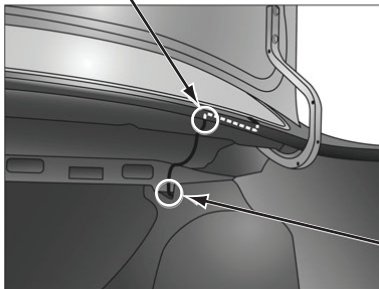

Route cable out of window moulding and into weatherstripping around trunk opening

Bring cable out of weatherstripping and into trunk



Route cable along trunk wall and into cabin through gap or conduit, along existing wiring harness

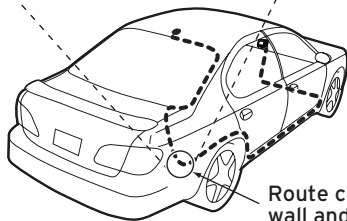

Route cable along trunk wall and into cabin

Vehicle Installation

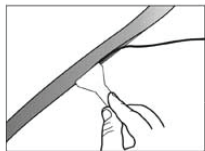

Use a blunt plastic putty knife or similar blunt tool to lift edge of interior trim and tuck cable under trim. Continue towards front of vehicle

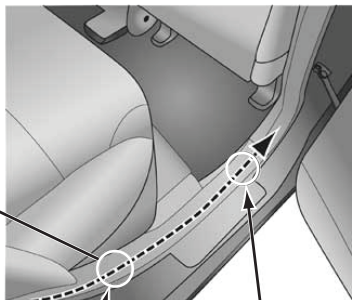

Route cable under trim or upholstery

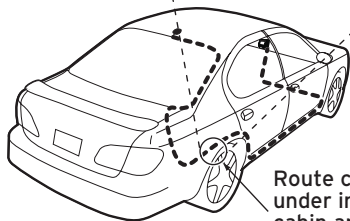

Route cable from trunk under interior trim, into cabin and towards front of vehicle

Continue routing cable under trim or carpet towards front of vehicle

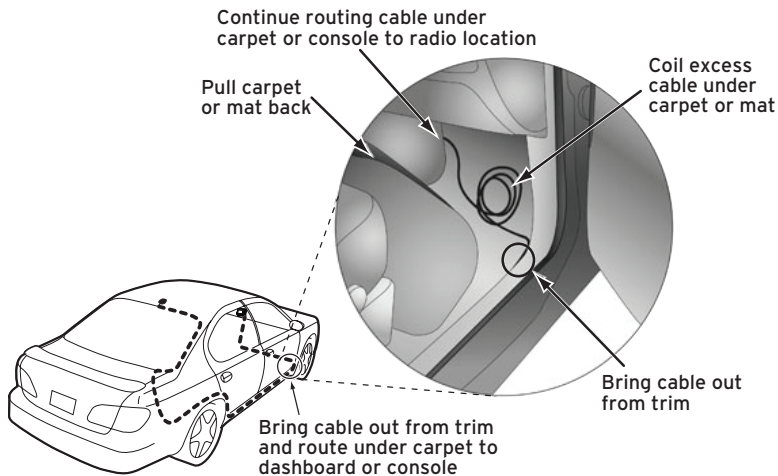

TIP! Always be careful to include enough slack in your cable to accommodate open doors or trunk lids. Use things typically found around the home, like electrical tape, to secure cables in areas so that hinges do not pinch the cable with the door. Hide any excess cable in the trim.

Vehicle Installation

- **Sedan/Coupe With Antenna Placed at the Rear of the Roof:**

1. Feed the antenna cable from the antenna underneath the rubber molding around the rear window. Use a blunt plastic putty knife or similar blunt tool to lift the rubber molding around the rear window and tuck the antenna cable underneath the molding. Route the antenna cable around and down the window to the lowest point. If your rear window does not have rubber molding, we recommend consulting a professional installer.
2. Route the antenna cable out of the window molding and into the rubber weather stripping around the trunk opening. Lift the weather stripping from the opening and tuck the cable inside it, then replace the weather stripping. To avoid sharp bends in the cable, run the cable inside the weather stripping for a few inches, then remove the cable from the weather stripping inside the trunk. Keep the cable away from hinges, gears, etc., that could damage it.
3. Route the cable out from the rubber weather stripping and along the trunk wall. Continue routing the cable into the vehicle cabin through a conduit or along an existing wiring harness.
4. Route the cable through the main cabin area under the interior trim, towards the front of the vehicle. Use a blunt plastic putty knife or similar blunt tool to lift the plastic trim just enough to tuck the cable underneath. Avoid side airbag locations on back pillars and above the doors. Airbag locations are marked with "SRS" logos. Be

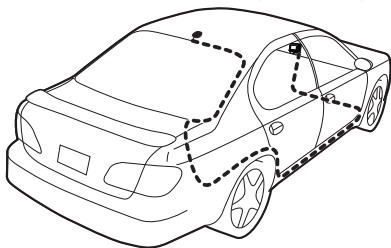

careful not to crimp or cut the cable.

5. Bring the cable out from the trim near the front of the cabin and route it under the carpet toward the dashboard or console. Coil any excess cable in a hidden location, such as under the carpet, keeping it away from any vehicle pedals or controls. Secure the excess cable with wire ties (purchased separately).
6. Bring the end of the cable out at the *PowerConnect* Vehicle Dock location. Leave yourself enough cable so you can easily connect it to the antenna connector of the dock.
7. Continue with "Step 5: Connect the Magnetic Mount Antenna and *PowerConnect* Power Adapter" on page 37.

Vehicle Installation

- **Sedan/Coupe With Antenna Placed at the Front of the Roof:**

1. Feed the antenna cable from the antenna underneath the rubber molding around the windshield. Use a blunt plastic putty knife or similar blunt tool to lift the rubber molding around the windshield and tuck the antenna cable underneath the molding. Route the antenna cable around and down the windshield to the lowest point.
2. At the lowest corner of the windshield, route the cable out of the windshield molding and into the rubber weather stripping around the door opening. Lift the weather stripping from the opening and tuck the cable inside it, then replace the weather stripping. Run the cable inside of the weather stripping to the bottom of the door opening.
3. Pull the cable out of the weather stripping at the bottom of the door opening and route it under the carpet toward the dashboard. Coil any excess cable in a hidden location, such as under the carpet, keeping it away from any vehicle pedals or controls. Secure the excess cable with wire ties.
4. Bring the end of the cable out at the *PowerConnect* Vehicle Dock location. Leave yourself enough cable so you can easily connect it to the antenna connector of the dock.
5. Continue with "Step 5: Connect the Magnetic Mount Antenna and *PowerConnect* Power Adapter" on page 37.

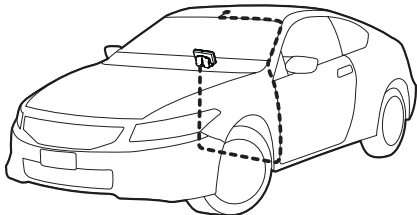

• SUV:

1. Feed the antenna cable underneath the rubber weather stripping of the rear tailgate window/door and route the cable along the rear hatch. Lift the weather stripping from the opening and tuck the cable inside it, then replace the weather stripping. Pull the cable out from weather stripping and route it into the cabin under the interior trim. Avoid hinges or gears that could crimp or cut the cable.
2. Route the cable through the SUV's main cabin area under the interior trim, towards the front of the vehicle. Use a blunt plastic putty knife or similar blunt tool to lift the plastic trim just enough to tuck the cable under underneath. Avoid side airbag locations on back pillars and above the doors. Airbag locations are marked with "SRS" logos. Be careful not to crimp or cut the cable.
3. Bring the cable out from the trim near the front of the cabin and route it under the carpet toward the dashboard or console. Coil any excess cable in a hidden location, such as under the carpet, keeping it away from any vehicle pedals or controls. Secure the excess cable with wire ties (purchased separately).
4. Bring the end of the cable out at the *PowerConnect Vehicle Dock* location. Leave yourself enough cable so you can easily connect it to the antenna connector of the dock.
5. Continue with "Step 5: Connect the Magnetic Mount Antenna and *PowerConnect Power Adapter*" on page 37.

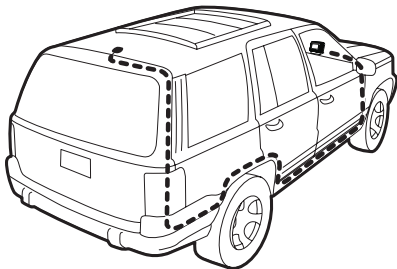

Vehicle Installation

- **Convertible:**

1. Bring the antenna cable from the antenna into the trunk at the front edge of the trunk lid. Keep any bends in the cable loose. Tape or tie the cable along the inside of the trunk lid to the trunk lid hinge strut.
2. Allow enough slack in the cable so the trunk lid can easily open and close and keep the cable away from hinges, gears, etc., that could crimp or cut it. Route the cable along the trunk wall and into the cabin through a conduit or along an existing wiring harness.
3. Route the cable through the main cabin area under the interior trim, towards the front of the vehicle. Use a blunt plastic putty knife or similar blunt tool to lift the plastic trim just enough to tuck the cable under underneath. Avoid side airbag locations on back pillars and above the doors. Airbag locations are marked with "SRS" logos. Be careful not to crimp or cut the cable.
4. Bring the cable out from the trim near the front of the cabin and route it under the carpet toward the dashboard or console. Coil any excess cable in a hidden location, such as under the carpet, keeping it away from any vehicle pedals or controls. Secure the excess cable with wire ties (purchased separately).
5. Bring the end of the cable out at the *PowerConnect* Vehicle Dock location. Leave yourself enough cable so you can easily connect it to the antenna

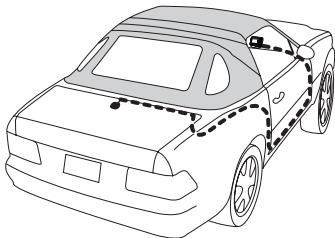

connector of the dock.

6. Continue with "Step 5: Connect the Magnetic Mount Antenna and PowerConnect Power Adapter" on page 37 .

• **Pickup Truck:**

1. Use a blunt plastic putty knife or similar blunt tool to lift the rubber molding around the windshield and tuck the antenna cable underneath it.
2. Continue tucking the cable underneath the windshield molding around the windshield to the lowest corner.
3. At the lowest corner of the windshield, route the cable out of the windshield molding and into the rubber weather stripping around the door opening. Lift the weather stripping from the opening and tuck the cable inside it, then replace the weather stripping. Run the cable inside of the weather stripping to the bottom of the door opening.
4. Pull the cable out of the weather stripping at the bottom of the door opening and route it under the carpet toward the dashboard. Coil any excess cable in a hidden location, such as under the carpet, keeping it away from any vehicle pedals or controls. Secure the excess cable with wire ties.

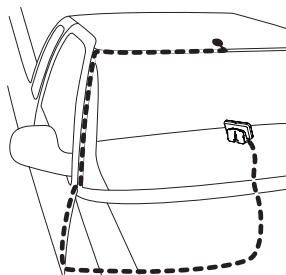

Vehicle Installation

5. Bring the end of the cable out at the *PowerConnect Vehicle Dock* location. Leave yourself enough cable so you can easily connect it to the antenna connector of the dock.
6. Continue with “Step 5: Connect the Magnetic Mount Antenna and *PowerConnect Power Adapter*” on page 37.

Step 5: Connect the Magnetic Mount Antenna and PowerConnect Power Adapter

1. Plug the Magnetic Mount Antenna into the **silver ANT** connector on the PowerConnect Vehicle Dock.

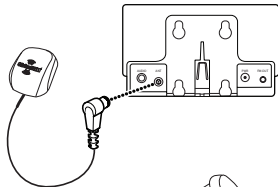

2. Insert the PowerConnect Power Adapter into your vehicle's cigarette lighter or power adapter socket.

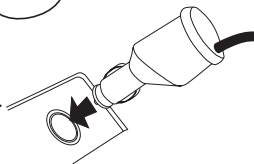

3. Plug the PowerConnect Power Adapter into the **red PWR** connector on the dock.

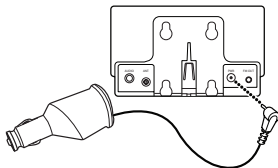

Vehicle Installation

Step 6: Connect the Audio

To play audio through your vehicle's stereo or FM radio, decide on one of the following audio connection options:

- **Option 1: Best:** Use the **Aux In Cable** if your vehicle's stereo system has an auxiliary input connection. Refer to your vehicle's owners manual to find the location of the auxiliary input jack, or consult the vehicle dealer.



TIP! The auxiliary input jack may be located on the face plate of the vehicle radio, on the back of the radio, anywhere on the front dash panel, inside the glove compartment, or inside the center console in between the front seats.

- **Option 2: Better:** Use a **Cassette Adapter** if your vehicle has a built-in cassette player. Cassette Adapters are sold separately and can be purchased from an electronics retailer, or go to siriusxm.ca.
- **Option 3: Good:** Use the **PowerConnect** feature in the Onyx. **PowerConnect** plays the audio through your vehicle's FM radio.
- **Option 4: Best:** Use the **FM Direct Adapter**. If none of the previous three audio connection options will work in your vehicle, then you will need to use the FM Direct Adapter (FMDA) (sold separately). The FMDA needs to be installed by a professional installer and directly connects the Onyx to your vehicle's FM radio.

Follow the installation instructions in the next several sections for the audio connection option that you have selected.

Option 1: Aux In Cable Installation Instructions

1. Plug one end of the Aux In Cable into the **green AUDIO** connector on the dock.

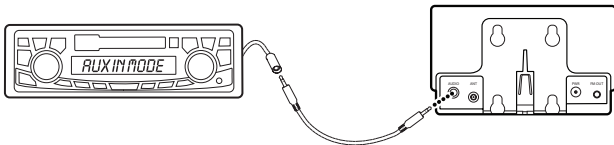

2. Plug the other end into the auxiliary input jack connection of your vehicle's stereo system.
3. Insert the dock into the mount.
4. Insert your Onyx into the dock.
5. Power on your Onyx by pressing the **Power button**.
6. Be sure the vehicle is outside and the antenna has a clear view of the sky. Verify that you are receiving the XM signal. There should be at least one bar on the lower left corner of the main display screen that denotes antenna signal

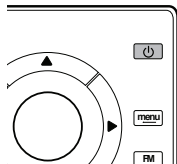
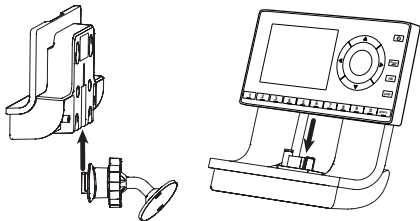

Vehicle Installation

strength. You can also press **menu** and then press ▼ to scroll to and highlight **Signal Indicator**. Press the **Select** button. The Satellite and Terrestrial bars show the strength of the signal being received. If the signal reception is good, press and hold **menu** to return to the main display screen.

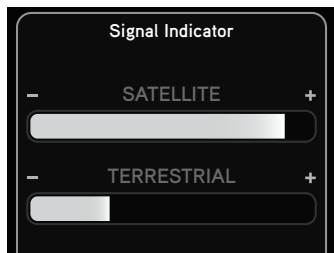

7. Ensure Onyx is tuned to channel 1. Upon power up, Onyx should tune to channel 1 by default, when it's not yet activated. If it's not on channel 1, refer to "Listening to Satellite Radio" on page 55 to learn about how to tune a channel.
8. Turn on your vehicle's stereo system. Set it to play input from the auxiliary input source.
9. You should hear XM channel 1 through your vehicle's stereo system. You are now ready to activate your Onyx.
10. Go back to "Step 2: Install the Dash or Vent Mount" on page 16 and finish installing the Dash or Vent Mount. Then the installation is complete.
11. The audio level output of the Onyx can be increased or decreased as necessary to match the audio levels of other sources in your vehicle. Refer to "Set Audio Level" on page 80.

If the signal reception is good, but there is no audio when tuned to channel 1, be sure the vehicle's stereo system is set to the correct source, i.e., auxiliary input source (step 8). Also be sure that the audio level is set high enough to be heard (step 10). Refer to "Troubleshooting" on page 92 for additional help.

Option 2: Cassette Adapter Installation Instructions

1. Plug the Cassette Adapter into the **green AUDIO** connector on the dock.
2. Insert the Cassette Adapter into the vehicle's cassette deck. You may need to turn on your vehicle's stereo system in order to do so.
3. Insert the dock into the mount.
4. Insert your Onyx into the dock.
5. Power on your Onyx by pressing the **Power** button.
6. Be sure the vehicle is outside and the antenna has a clear view of the sky. Verify that you are receiving the XM signal. There should be at least one bar on the lower left corner of the main display screen that denotes antenna signal strength. You can also press **menu** and then press **▼** to scroll to and highlight **Signal Indicator**.

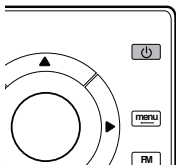
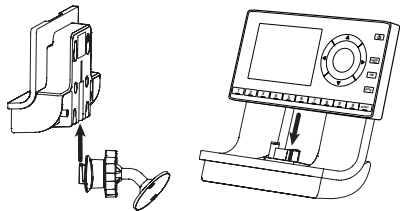
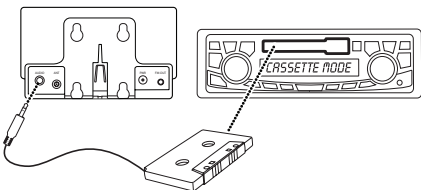

Vehicle Installation

Press the **Select** button. The Satellite and Terrestrial bars show the strength of the signal being received. If the signal reception is good, press and hold **menu** to return to the main display screen.

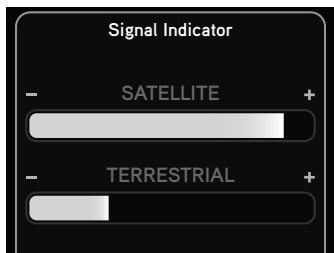

7. Ensure Onyx is tuned to channel 1. Upon power up, Onyx should tune to channel 1 by default, when it's not yet activated. If it's not on channel 1, refer to "Listening to Satellite Radio" on page 55 to learn about how to tune a channel.
8. If you haven't done so, turn on your vehicle's stereo system. Set it to play input from the cassette source.
9. You should hear XM channel 1 through your vehicle's stereo system. You are now ready to activate your Onyx.
10. Go back to "Step 2: Install the Dash or Vent Mount" on page 16 and finish installing the Dash or Vent Mount. Then the installation is complete.
11. The audio level output of the Onyx can be increased or decreased as necessary to match the audio levels of other sources in your vehicle. Refer to "Set Audio Level" on page 80.

If the signal reception is good, but there is no audio when tuned to channel 1, be sure the vehicle's stereo system is set to the correct source, i.e., cassette source (step 8). Also be sure that the audio level is set high enough to be heard (step 10). Refer to "Troubleshooting" on page 92 for additional help.

Option 3: *PowerConnect* Installation Instructions

1. Insert the dock into the mount.
2. Insert your Onyx into the dock.
3. Power on your Onyx by pressing the **Power button**.
4. Be sure the vehicle is outside and the antenna has a clear view of the sky. Verify that you are receiving the XM signal. There should at least be one bar on the lower left corner of the main display screen that denotes antenna signal strength. You can also press **menu** and then press ▼ to scroll to and highlight **Signal Indicator**. Press the **Select button**. The Satellite and Terrestrial bars show the strength of the signal being received. If the signal reception is good, press and hold **menu** to return to the main display screen. You are ready to make the audio connection.
5. You'll first need to find an available FM channel. An available FM

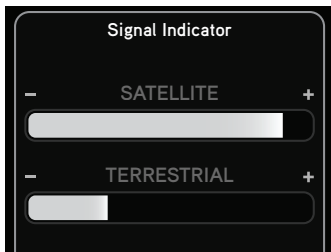
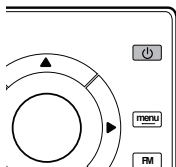
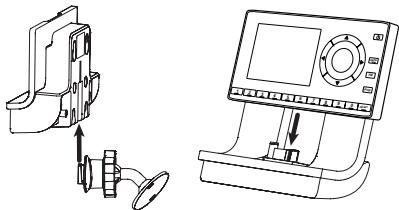

Vehicle Installation

channel is one that's not being used by an FM radio station in your area. When you tune your FM radio to an available channel, you should only hear static or silence - not talk or music. To find an available FM channel:

- Manually tune through your local FM channels on your vehicle's FM radio. Locate and create a list of channels that aren't being used by any FM radio station. Write down the list. Once you have created your list of available FM channels, you will need to find the one that provides the best match for Onyx.



TIP! You'll need to use the 'Manual' tune function on your vehicle's FM radio to tune through every FM channel one-by-one. Turn on your vehicle's FM radio. Start at 88.1 and use the 'Manual' tune function on your vehicle's FM radio to tune through each FM channel one-by-one (88.1 followed by 88.3 etc.) to locate channels that aren't being used by a local FM radio station. Write down each FM channel that has only static or silence on it, until you reach 107.9.

- 6 Ensure Onyx is tuned to channel 1. Upon power up, Onyx should tune to channel 1 by default, when it's not yet activated. If it's not on channel 1, refer to "Listening to Satellite Radio" on page 55 to learn about how to tune a channel.
- 7 Pick the first FM channel on your list from step 5. Turn on your vehicle's FM radio (if you have not already done so) and tune it to this FM channel.



NOTE! If you are using the Vehicle Dock from the Universal Xpress Car Kit instead of the *PowerConnect* Vehicle Dock which came with your Onyx, you will have to disable AUX Detect. Refer to "Using the Vehicle Dock From the Universal Xpress Car Kit" on page 87 , and complete the additional instructions before continuing with the next step.

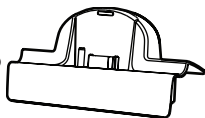

8. Set your Onyx to transmit on the same FM channel that you have selected in step 7:

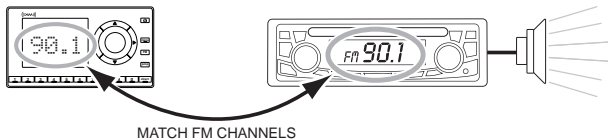

- i. Press **menu**.
- ii. Press ▼ to scroll to and highlight **FM Settings** and press the **Select button**.
- iii. **FM Channels** will be highlighted. If it is not highlighted, turn on the FM transmitter by highlighting **FM transmitter** and pressing **Select**.
- iv. Once the FM Transmitter is **On**, select **FM Channels** and press ▼ to scroll to and highlight the storage location **FM2** and press the **Select button**.
- v. Tune to the available FM channel you found in step 7. Press ◀ and ▶ to tune in steps of .2, i.e., 99.3 to 99.5. Press ▼ and ▲ to tune in steps of 1, i.e., 99.3 to 100.3. Press the **Select button** to select

Vehicle Installation

- the FM channel.
- vi. **Start Using** is highlighted. Press the **Select** button.
 - vii. The FM channel you selected will be confirmed on the display screen. The Onyx will tune to the FM channel.
9. You should hear XM channel 1 through your vehicle's stereo system. You are now ready to activate your Onyx.
 10. Go back to "Step 2: Install the Dash or Vent Mount" on page 16 and finish installing the Dash or Vent Mount. Then the installation is complete.
 11. If the selected FM channel doesn't work well for you, work down the list of FM channels until you find one that allows you to hear XM clearly. Each time, you will need to tune your vehicle's FM radio to the FM channel and then set your Onyx to transmit on the same FM channel (steps 7 & 8).

FM Channels		
FM 1	97.9	current
FM 2	--	--
FM 3	--	--
FM 4	--	--
FM 5	--	--

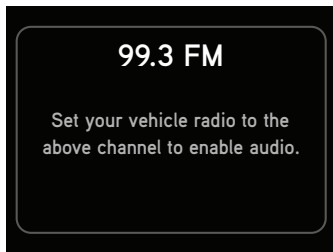

If the signal reception is good, but there is no XM audio when tuned to channel 1, verify that both the Onyx and your vehicle's FM radio are tuned to the same FM channel (steps 7 & 8). Also ensure the chosen FM channel is a suitable one to use in your area (step 5). Verify that nothing is plugged into the **AUDIO** connector on the *PowerConnect Vehicle Dock*. Refer to "Troubleshooting" on page 92 for additional help.

Option 4: FM Direct Adapter (FMDA) Installation

The FMDA needs to be installed by a professional installer. Professional installation can help improve your radio's reception and significantly reduce the visibility of wires. To learn more, check with the retailer where you bought your radio, or go to siriusxm.ca.

Activation

Activation

Onyx works on the XM network and requires a XM subscription. Before you can start listening, please do the following:

1. Make sure your Onyx is properly installed and receiving the XM signal so that you can hear the audio on channel 1.
2. Make a note of your XM Radio ID. You can find it on channel 0, on a label on the bottom of the gift box, and on the label on the back of your Onyx.



NOTE! The XM Radio ID does not use the letters I, O, S, or F.

3. Activate your service:

- Online: Go to www.xmradio.ca and click on "ACTIVATE SUBSCRIPTION"

OR

- By phone: Call 1-877-GET-XMSR (1-877-438-9677)



TIP! You can follow the built in activation wizard in your Onyx. If your radio has not been activated, press **menu** and the first item in the list will be **Activate Radio**. Press the **Select button**. A series of screens will guide you through the activation process. Follow the instructions on each screen. Press the **Select button** to advance to the next screen, or **menu** to cancel and return to the main display screen.

4. When your service is activated, your Onyx will receive all channels to which you have subscribed. At this time, if you press **▲** or **▼**, you can scroll and tune other channels. Activation usually takes 10 to 15 minutes, but may take up to an hour. We recommend that your radio remain on until activated.

Welcome

The next few screens will help you activate your satellite radio. Please press **Select** to continue with the activation of your radio, or press **menu** to cancel activation at this time.

Press **Select** to continue

Using Your Onyx

Using Your Onyx

The Main Display

When listening to a channel, information about the channel is displayed.

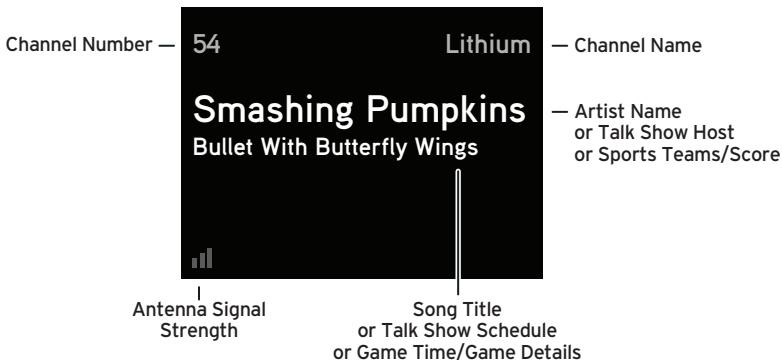

Navigation Basics

Power Button



Pressing the **Power button** turns the Onyx On or Off.

Navigation Buttons



Use the **Left**, **Right**, **Up**, and **Down** buttons to navigate through various features and functions of Onyx.

- **Left ◀ or Right ▶ button:** Displays the channel categories such as Rock, Pop, Sports, Talk/New etc. Repeated presses cycle through the categories one at a time. Decreases or increases the settings of various menu options such as Brightness, Audio Level, etc.
- **Up ▲ or Down ▼ button (press and release):** Immediately tunes to the next or previous channel in the channel lineup. Scrolls through lists and highlights an item in the list.
- **Up ▲ or Down ▼ button (press and hold):** Continuously scrolls through any list. While on the main display screen, continuously scrolls through the channel lineup and briefly displays the information of each channel. When the button is released, radio tunes to the last channel it had scrolled to in the channel lineup.

Select Button



The **Select button** selects a highlighted item in a list and confirms settings.

Using Your Onyx

Menu Button



Pressing **menu** displays various options to make setup and feature changes. Pressing **menu** when in menu options returns to the previous menu option screen until menu options is exited. Pressing and holding **menu** returns to the main display screen in most instances.

FM Button



Provides easy tuning of FM presets for optimized *PowerConnect* performance. Repeatedly pressing **FM** displays and cycles through the list of preset FM channels one at a time. The radio automatically tunes to the displayed FM channel. Pressing and holding **FM** accesses the FM Settings menu. It is not available when Aux In Cable or Cassette Adapter is used for audio connection.

Jump Button



Pressing the **jump** button will allow you to tune to the previous channel that was being played.

Direct Button



Pressing **direct** prompts for the entry of a channel number using the number buttons. Once the channel number is entered, the radio directly tunes to the new channel.

Number Buttons



Each number button stores a favourite channel in its button location and provides one touch access to it afterward. Number buttons also directly tune to a channel when the channel number is entered after pressing **direct**.

Listening to Satellite Radio

Tune a channel:

1. Press and release ▲ and ▼ to immediately tune to the next or previous channel.
2. Press and hold ▲ and ▼ to quickly scroll through the channels. Release to tune to the channel that is displayed.

View a category:

Channels are organized into categories to make it easier for you to find the ones that suit your taste.

To view a category press ◀ or ▶.

1. Scroll through the category using ▲ and ▼, and find the channel you want.
2. Press the **Select button** to select the channel, or press ◀ or ▶ for the previous or next category.

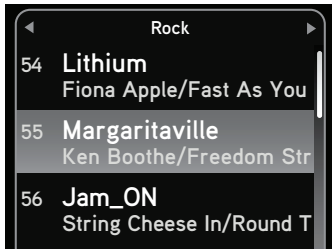

TIP! To briefly listen to each channel in the category, scroll to and highlight Scan at the end of the category list and press the **Select button**. Refer to "Scanning Channels in a Category" on page 59 to learn more about Scan.

Using Your Onyx

Direct Tune

A channel can be tuned directly by entering the channel number using the number buttons.

1. To directly tune a channel press **direct**.

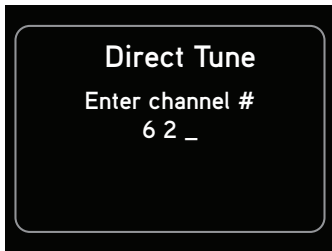

2. Use the number buttons **0-9** to enter the channel number and wait a moment until the channel is tuned, or press the **Select button** to immediately tune to the channel.

Jump

Pressing the jump button tunes the channel which you were previously listening to.

Return to Main Display Screen

Pressing and holding **menu** in most instances will return you to the main display screen. In some cases, you may need to follow the instructions on the display screen.

Using Your Onyx

Favourite Channels

You can set up to 10 of your favourite channels so you can easily access them. Each favourite channel can be assigned to a number button.

To assign a favourite channel to a number button:

1. Tune to the desired channel.
2. Press and hold the number button **0-9** you want to assign to that favourite channel.

To listen to a favourite channel:

1. Press the number button **0-9** that was assigned to the desired favourite channel.



TIP! When you are at the main display screen, press  to see your list of favourite channels. Scroll to highlight a favourite and press the **Select button** to listen to that channel.

Favorite Saved

26 The Pulse
saved as
Favorite 1

Scanning Channels in a Category

You can scan a category and listen to each channel for 10 seconds before the next channel is automatically tuned. If you want to stay tuned to the channel being played and stop the scan, just press the **Select button**.

To scan a category:

1. Press ◀ or ▶ until the desired category is displayed.
2. Scroll down to highlight the last item in the category which will be **Scan** and the category name.
3. Press the **Select button**. The scan will begin.
4. Press the **Select button** to stop the scan, and continue to listen to the channel currently being played, or press ▼ or ▲ to return to the channel you were listening to before you began the scan.

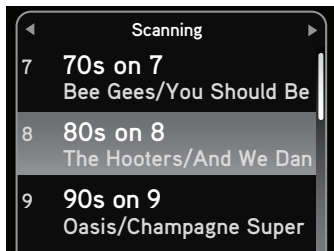
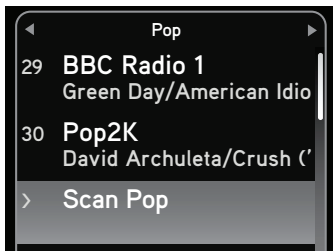

Using Your Onyx

FM Presets

FM presets make it easy to quickly access stored FM channels and choose a new FM channel from them.

Use FM presets when you use *PowerConnect* to listen to your Onyx through your vehicle's FM radio. (Refer to "Option 3: *PowerConnect* Installation Instructions" on page 43 for more information.)

To start using a different FM preset:

1. Press **FM** to display the current FM preset.
2. To display and select the next FM preset, press **FM**. The radio will tune to the displayed FM channel. If the preset is the one you want, press **menu** or wait for the screen to timeout.
3. Repeatedly pressing **FM** will cycle through the FM presets.
4. Set your vehicle's FM radio to the same FM channel.



IMPORTANT! You need to ensure that your vehicle's FM radio is tuned to the same FM channel.

99.3 FM

Set your vehicle radio to the above channel to enable audio.

103.7 FM

Set your vehicle radio to the above channel to enable audio.



TIP! To configure the list of preset FM channels, you need to find available FM channels in your area. Refer to “Find Available FM Channels in Your Area” on page 73. Next, refer to “Set and Select an FM Channel” on page 75.

Special Features

Special Features

Colour Themes

You can change the colour of the display screen to one of 6 colour themes: Blue, Red, Amber, Yellow, Silver, or Teal. You can coordinate the colour theme with your vehicle dash lights and with the Trim Ring of your choice for your Onyx. The default colour theme is blue.

To change the colour theme:

1. Press **menu**.
2. Press ▼ to scroll to and highlight **Colour Theme**. Press the **Select button**.
3. Press ◀ or ▶ to highlight the desired colour theme. The Onyx will immediately change to the selected colour theme.
4. Press the **Select button** to confirm the selected colour theme.
5. Press and hold **menu** to return to the main display screen.

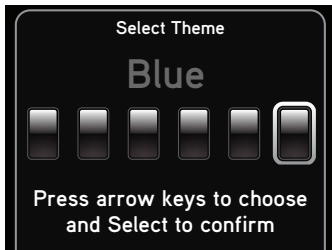

Parental Controls

Your Onyx has a parental control feature which will allow you to lock access to channels, or lock access to an entire category. A 4-digit code controls access to the locked channel or locked category.

When you browse a category, the locked channel number or locked category will be shown but not the artist and song/show information. Instead, a lock icon  and the word "Locked" is shown. If you scroll through the channels using ▼ and ▲, the locked channels are skipped and not displayed.

If you attempt to tune to a locked channel, either by using direct tune or through the category list, you'll be prompted to enter your 4-digit code. When the correct code is entered, you'll be able to tune to and listen to the channel. All locked channels become unlocked and will remain unlocked until you turn the Onyx Off, and back On. In the category list, the previously locked channels will show an unlocked icon .

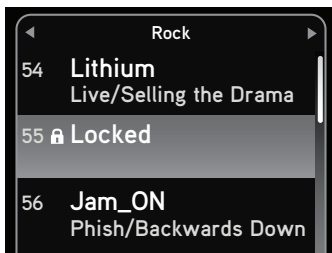

To turn Parental Controls On (or Off):

1. Press **menu**.
2. Press ▼ to scroll to and highlight **Parental Controls**. Press the **Select button**.
 - If this is the first time you want to turn on Parental Controls, **Parental Controls** will be highlighted. Press the **Select button**. You will be prompted to select a 4-digit code:

Special Features

- i. For each digit, press one of the 0-9 keys and then press ► to advance to the next digit. (Press ◀ if you need to go back and edit a previous digit.)
 - ii. When you have selected all 4 digits of your code press the **Select button**.
 - iii. The Code Confirmation screen will be displayed. For your records, write down the code you have selected. Press the **Select button**. Continue with step 3.
- If you had previously selected a 4-digit code you will be prompted to enter your code:
 - i. For each digit, press one of the 0-9 keys and then press ► to advance to the next digit. (Press ◀ if you need to go back and edit a previous digit.)
 - ii. When you have selected all 4 digits of the code press the **Select button**.
3. At the “Parental Controls” screen, **Parental Controls** will be highlighted. Press the **Select button** to turn parental control On (or press the **Select button** to turn parental control Off).

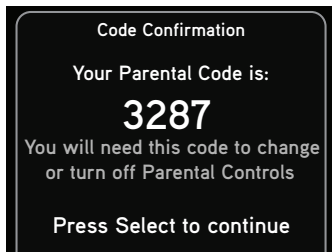
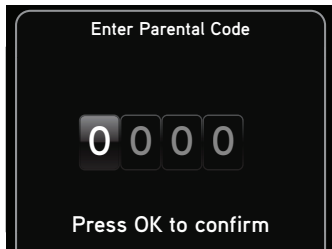

4. Press and hold **menu** to return to the main display screen.

To lock (or unlock) channels or categories:

1. Press **menu**.
2. Press ▼ to scroll to and highlight **Parental Controls**. Press the **Select button**.
3. You will be prompted to enter the 4-digit code. For each digit, press one of the 0-9 keys and then press ► to advance to the next digit. (Press ◀ if you need to go back and edit a previous digit.)
4. When you have entered all 4 digits of the code press the **Select button**.
5. If **Parental Controls** is shown as Off, press the **Select button** to turn it On, otherwise continue with the next step.
6. At the "Parental Controls" screen, Press ▼ to scroll to and highlight **Locked Channels**. Press the **Select button**.
7. A list of all the categories and the channels in each category will be displayed. Press ▼ and ▲ to scroll to and highlight a channel or category you want to lock. Press the **Select button**. A lock icon  will be displayed to the left of the channel or category you locked. (To unlock a locked channel or category, simply highlight the locked channel or category and press the **Select button**. The lock icon will disappear indicating the channel or category is unlocked.)

Special Features

Locked Channels

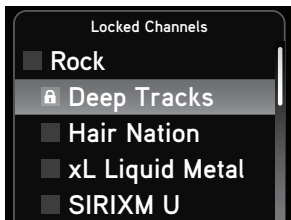

Locked Categories

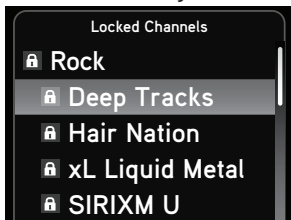

8. You can continue to lock and unlock as many channels or categories as you wish. When you are finished press and hold **menu** to return to the main display screen.

To change your code:

1. Press **menu**.
2. Press ▼ to scroll to and highlight **Parental Controls**. Press the **Select button**.
3. You will be prompted to enter your existing 4-digit code. For each digit, press one of the **0-9** keys and then press ► to advance to the next digit. (Press ◀ if you need to go back and edit a previous digit.)
4. When you have entered all 4 digits of the code press the **Select button**.
5. If **Parental Controls** are shown as Off, press the **Select button** to turn it On, otherwise continue with the next step.

6. At the "Parental Controls" screen, Press ▼ to scroll to and highlight **Change My Code**. Press the **Select button**.
7. You will be prompted to enter a new 4-digit code. For each digit, press one of the 0-9 keys and then press ► to advance to the next digit. (Press ◀ if you need to go back and edit a previous digit.)
8. The Code Confirmation screen will be displayed. For your records, write down the code you have selected. Press the **Select button**.
9. Press and hold **menu** to return to the main display screen.

Code Confirmation

Your Parental Code is:

3287

You will need this code to change
or turn off Parental Controls

Press Select to continue

Special Features

To listen to a locked channel:

There are two ways to tune to a channel which has been locked. The first is by directly tuning the locked channel, and the second is to select the locked channel from a category list.

1. Directly tune or select the locked channel:

To directly tune a locked channel:

- i. Press **direct** and enter the channel number using the **0-9** keys.

To select a locked channel from the category list:

- i. Press ◀ or ▶ to display the category list of the locked channel you wish to tune.
 - ii. Press ▼ to scroll to and highlight the locked channel. Press the **Select button**.
2. You will be prompted to enter your existing 4-digit code. For each digit, press one of the **0-9** keys and then press ▶ to advance to the next digit. (Press ◀ if you need to go back and edit a previous digit.)
 3. When you have entered all 4 digits of the code press the **Select button**. If your code is correct the channel will be tuned. All locked channels become unlocked and will remain unlocked until you turn the Onyx Off, and back On. In the category list, the previously locked channels will show an unlocked icon .

Configuring Your Onyx

Configuring Your Onyx

Radio ID

Your Onyx has an alphanumeric ID which uniquely identifies the radio. This ID is used during the activation process.

To display the Radio ID:

1. Press **menu**.
2. **Radio ID** will be highlighted. If it is not highlighted, press ▼ to scroll to and highlight **Radio ID**. Press the **Select button**. The Radio ID will be displayed.
3. Press and hold **menu** to return to the main display screen.

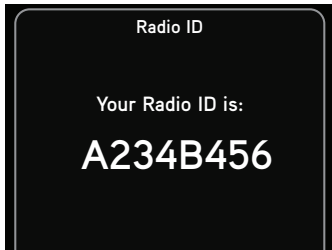

Find Available FM Channels in Your Area

Before attempting any of the procedures below, you should park your vehicle in a safe location. Do not attempt to set up your FM channels or any Onyx function while driving.

PowerConnect allows you to listen to XM audio through your vehicle's FM radio. You will first need to find an available FM channel, which is a channel that is not being used by an FM radio station in your area. When you tune your FM radio to an available channel, you should only hear static or silence - not talk or music.

Once you have found an available channel, you need to tune Onyx's built-in transmitter to the same channel to receive XM sound through your vehicle's radio.

To find an available FM channel:

- Manually tune through your local FM channels
 1. Manually tune through your local FM channels on your vehicle's FM radio. Turn on your vehicle's FM radio. Start at 88.1 and use the 'Manual' tune function on your vehicle's FM radio to tune through each FM channel one-by-one (88.1 followed by 88.3 etc.) to locate channels that aren't being used by a local FM radio station. Write down each FM channel that has only static or silence on it, until you reach 107.9. Once you have created your list of available FM channels, you will need to find the one that provides the best match for Onyx.
 2. Tune Onyx to a favourite XM channel (or to channel 1, if it's not yet activated). Pick the first FM channel on your list and tune the FM radio to that channel. Then tune the Onyx to the same FM channel. (Refer to "Set and Select an FM Channel" on page 75.) You should hear the XM channel through your vehicle's radio. If you are satisfied with the sound quality, you're done! If this FM channel doesn't work well for you, work

Configuring Your Onyx

down the list until you find an FM channel that allows you to hear XM clearly.



NOTE! You may find an FM channel with static or silence that does not work with Onyx. It is possible that some type of inaudible interference is present that prevents reception of the Onyx broadcast. Your only options are to use another FM channel or a different audio connection method.



TIP! If you regularly drive from one location to another, such as your daily commute, you may need to use different FM channels along your route for best performance. If this is the case, we recommend saving the best FM channels as presets on your FM radio and Onyx. Then you simply select and match the best channel for the area you are in.



TIP! It will be much more difficult to find available FM channels in large cities than in most suburban or rural locations. A direct audio connection using the Aux In Cable, Cassette Adapter or professional installation is your best solution if you drive in or near large metropolitan areas.



NOTE! The performance of FM radios are different, based on manufacturer and vehicle style. Some may not work well with the type of FM transmitter used by Onyx. This is why we recommend a direct audio connection using the Aux In Cable or Cassette Adapter if they can be used in your vehicle. Professional installation can also resolve almost any performance issue.

Set and Select an FM Channel

The Onyx allows you to easily store (i.e., preset) up to 5 different FM channels. At any time, you can select any one of these 5 FM presets to transmit audio from the Onyx to your vehicle's FM radio. Having a choice of 5 FM presets also makes it easy to switch to the appropriate FM channel as you travel from one area to another. Each FM preset is stored in its own storage location. You can easily add or edit the FM preset in any one of the 5 storage locations.



IMPORTANT! The Onyx and the vehicle's FM radio need to be tuned to the same FM channel in order to hear the audio.



TIP! The FM 1 storage location is preset with FM channel 97.9.

To set and select an FM preset:

1. Press **menu**.
2. Press ▼ to scroll to and highlight **FM Settings** and press the **Select button**.
3. **FM Channels** will be highlighted. If it is not highlighted, turn on the FM transmitter by highlighting **FM Transmitter** and pressing **Select**.
4. Once the FM Transmitter is **On**, select **FM Channels** and press ▼ to scroll to and highlight the storage location **FM2** and press the **Select button**. You can choose among the following options:

FM Channels	
FM 1	97.9
FM 2	99.3 <small>current</small>
FM 3	103.7
FM 4	— — —
FM 5	— — —

Configuring Your Onyx

- i. If the chosen storage location is empty (denoted by "---"), or if the storage location contains the FM preset currently being used (denoted by "current"), then the FM channel tuning screen is displayed.
 - ii. If the chosen storage location has an FM preset that is not currently being used, and you want to edit it, **Edit Channel** is highlighted. Press the **Select** button. The FM channel tuning screen is displayed.
 - iii. If the chosen storage location has an FM preset that is not currently being used, and you want to start using it, press ▲ to highlight **Start Using** and press the **Select** button. Skip to step 7.
5. Press ◀ and ▶ to tune the desired FM channel in steps of .2, i.e., 99.3 to 99.5. Press ▼ and ▲ to tune the desired channel in steps of 1, i.e., 99.3 to 100.3. Press the **Select** button to select the FM channel.
6. If you are editing the storage location that has the "current" FM preset, skip to step 7. Otherwise, **Start Using** will be highlighted. Press the **Select** button.



NOTE! You can also preset an FM channel in a storage location without having to start using it right away. Just press menu and exit the screen.

7. The chosen FM channel will be confirmed on the display screen and the Onyx will tune to that FM channel.
8. Set your vehicle's FM radio to same FM channel.



IMPORTANT! You'll first need to find a suitable FM channel that is unused or available in your area.

99.3 FM

Set your vehicle radio to the above channel to enable audio.

Configuring Your Onyx

To quickly select an FM channel from the preset list:

1. Press **FM** to display the current FM preset.
2. To display and select the next FM preset, press **FM**. The radio will tune to the displayed FM channel. If the preset is the one you want, press **menu** or wait for the screen to timeout.
3. Repeatedly pressing **FM** will cycle through the FM presets.
4. Set your vehicle's FM radio to same FM channel.

99.3 FM

Set your vehicle radio to the above channel to enable audio.

103.7 FM

Set your vehicle radio to the above channel to enable audio.

Set Brightness

To change the display's brightness:

1. Press **menu**.
2. Press ▼ to scroll to and highlight **Brightness** and press the **Select button**.
3. Press ◀ to decrease or ▶ to increase the brightness of the display.
4. Press the **Select button** to confirm the brightness setting.
5. Press and hold **menu** to return to the main display screen.



Configuring Your Onyx

Set Audio Level

The audio level of the Onyx can be adjusted when an audio connection is made between the dock and the vehicle's stereo system. Audio level is used to adjust the Onyx's volume level to match the volume of other audio sources you may use, such as a CD player, other FM stations, or an MP3 player.

Do not use the audio level as a volume control. Use the volume control on your vehicle's stereo instead.

To adjust the audio level:

1. Press **menu**.
2. Press ▼ to scroll to and highlight **Audio Level** and press the **Select button**.
3. Press ◀ to decrease or ▶ to increase the audio level.
4. Press the **Select button** to confirm the new audio level.
5. Press and hold **menu** to return to the main display screen.

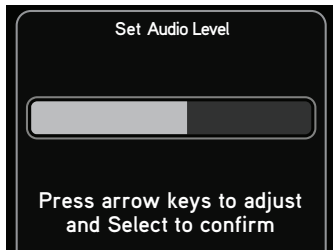

Signal Indicator

For best reception, your Magnetic Mount Antenna should have an unobstructed view of the XM satellites. In large cities, there are terrestrial transmitters (ground repeaters) to help increase the signal coverage.

Your Onyx can display the received strength of the satellite and terrestrial signals being received.

To display the signal strength:

1. Press **menu**.
2. Press ▼ to scroll to and highlight **Signal Indicator** and press the **Select** button.
3. The Satellite and Terrestrial bars show the strength of the signal being received.
4. Reposition the antenna if you are having trouble receiving the signal. Be sure your vehicle is outside with an unobstructed view of the sky.
5. Press and hold **menu** to return to the main display screen.

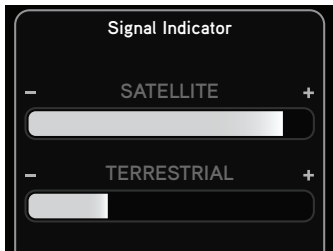

Configuring Your Onyx

Factory Settings

The factory settings menu has two choices, **AUX Detect** and **Restore Defaults**.

AUX Detect

AUX Detect allows the Onyx Radio to automatically detect a connection made to the **AUDIO** connector of the *PowerConnect Vehicle Dock* by an Aux In Cable or Cassette Adapter. AUX Detect is enabled by default.



IMPORTANT! If you are using the *PowerConnect Vehicle Dock* which came with your Onyx Radio, AUX Detect should remain enabled.

If you are using the older model Vehicle Dock from the Universal Xpress Car Kit, and plan to use *PowerConnect* or *FMDA* as the audio connection option, you will need to disable AUX Detect. Please read the additional instructions, "Using the Vehicle Dock From the Universal Xpress Car Kit" on page 87. Once AUX Detect is disabled, you'll have to turn the FM Transmitter On. Refer to "Turn FM Transmitter On/Off" on page 88.

To disable AUX Detect:

(Do this only when using the older model Vehicle Dock.)

1. Press **menu**.
2. Press ▼ to scroll to and highlight **Factory Settings** and press the **Select** button.



3. **AUX Detect** should be highlighted and show as enabled. Press the **Select button** to toggle the setting.
4. A warning screen will be displayed. Press the **Select button** to confirm that you want to disable AUX Detect.
5. If you want to cancel press **menu** to return to **Factory Settings**. AUX Detect will remain enabled.
6. AUX Detect will show as disabled. Press and hold **menu** to return to the main display screen.

To enable AUX Detect

(Do this when radio is transferred to the *PowerConnect* Vehicle Dock from an older model Vehicle Dock.)

1. Press **menu**.
2. Press ▼ to scroll to and highlight **Factory Settings** and press the **Select button**.
3. **AUX Detect** will be highlighted and show as disabled. Press the **Select button** again to toggle the setting to enabled.
4. Press and hold **menu** to return to the main display screen.

Configuring Your Onyx

Restore Defaults

You can clear all of your personal settings, such as favourite channels, FM presets etc. and return the radio to its original out-of-the-box settings

To reset Onyx to factory defaults:



NOTE! Restoring defaults permanently removes all personal settings.

1. Press **menu**.
2. Press ▼ to scroll to and highlight **Factory Settings** and press the **Select button**.
3. Press ▼ to scroll to and highlight **Restore Defaults** and press the **Select button**.
4. A warning screen will be displayed. If you are certain that you want to reset your Onyx to the default settings, press the **Select button** to confirm.
5. If you want to cancel, press **menu** to return to **Factory Settings**.

Are You Sure?

All settings will be erased.

Press **Select** to confirm
or **menu** to cancel

Demo Mode

Your Onyx has a demo mode that starts playing when, for a prolonged period of time (more than 5 minutes), the radio either detects it's not connected to the antenna, or the antenna stops receiving a signal. It disappears when the antenna is connected properly or when the radio starts receiving a signal. You can also exit demo mode at any time, by pressing and holding the **Select button** for 10 seconds. If desired, you can also manually put the Onyx in demo mode.

The ability for Onyx to enter demo mode is enabled by default. If you don't want Onyx to ever enter the demo mode, you can disable the demo feature. You can enable it again at another time if desired.

To enable or disable the demo mode:

1. Press **menu**.
2. Press ▼ to scroll to and highlight **Demo Mode** and press the **Select button**.
3. **Status** will be highlighted. Press the **Select button** to toggle the setting between enabled or disabled. (Repeatedly pressing the **Select button** toggles between the choices.)
4. If you have selected disabled, press and hold **menu** to return to the

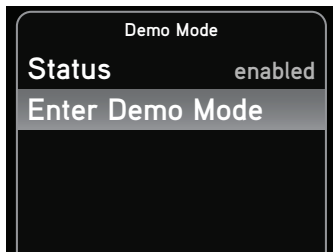

Configuring Your Onyx

main display screen. If you have selected enabled continue with step 5.

5. Press ▼ to scroll to and highlight **Enter Demo Mode** and press the **Select button**. The demo mode will start in 10 seconds.
6. To exit demo mode at any time, press and hold the **Select button** for 10 seconds.

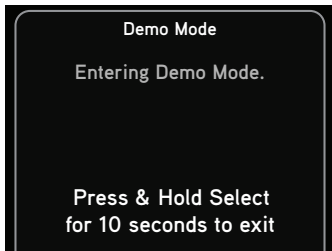

Using the Vehicle Dock From the Universal Xpress Car Kit

If you have chosen to use the Vehicle Dock from the Universal Xpress Car Kit rather than the *PowerConnect* Vehicle Dock included with your Onyx radio, you will need to complete some additional installation steps. When you have completed these additional steps, you can continue with the installation of your Onyx.

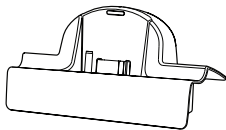

When you are using the Universal Xpress Vehicle Dock, the screen will initially display “AUX Connected” when you power on your Onyx. Ignore this message. Once you have completed the steps below, it will not be displayed again.

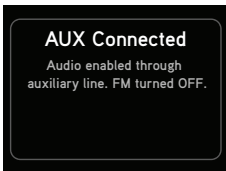

If you are connecting the audio using PowerConnect (or FMDA):

1. Disable the AUX Detect feature. Refer to “AUX Detect” on page 82, and disable AUX Detect.
2. Turn the FM Transmitter in the Onyx On. Refer to “Turn FM Transmitter On/Off” on page 88, and turn the FM Transmitter On.
3. Continue with the installation.

If you are connecting the audio using the Aux In Cable or Cassette Adapter:

1. Disable the AUX Detect feature. Refer to “AUX Detect” on page 82, and disable AUX Detect.



TIP! The FM Transmitter must be Off. To verify that the FM Transmitter is Off, refer to “Turn FM Transmitter On/Off” on page 88 .

2. Continue with the installation.

Configuring Your Onyx

Turn FM Transmitter On/Off

Turning the FM Transmitter On applies only if you are using the older model Vehicle Dock from the Universal Xpress Car Kit, and plan to use PowerConnect or FMDA as the audio connection option.

You'll have to turn On the FM Transmitter under the **FM Settings** menu. However, before you can access the **FM Settings** menu, you first need to disable AUX Detect. Refer to "AUX Detect" on page 82. Once you have disabled AUX Detect, the **FM Settings** menu will be accessible.

To turn the FM Transmitter On:

1. Press **menu**.
2. Press ▼ to scroll to and highlight **FM Settings** and press the **Select** button.
3. **FM Transmitter** will be highlighted. Press the **Select** button to toggle the setting from Off to On.
4. The **FM Channels** menu item will now be accessible, allowing you to tune the Onyx and the FM radio in your vehicle to the same FM channel.

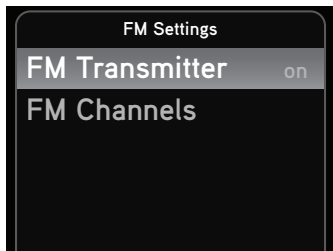

TIP! Onyx is programmed with FM channel 97.9 as the default setting.

To turn the FM Transmitter Off:

If you are using the older model Vehicle Dock from the Universal Xpress Car Kit, and plan to use the Aux In Cable or a Cassette Adapter as the audio connection option, you'll have to turn the FM Transmitter under the **FM Settings** menu in the Onyx Radio Off, if it was previously turned On.

1. Press **menu**.
2. Press ▼ to scroll to and highlight **FM Settings** and press the **Select button**.
3. **FM Transmitter** will be highlighted. Press the **Select button** to toggle the setting from On to Off.
4. A warning message will be displayed advising you to connect the Aux In Cable. Press the **Select button** to confirm that you want to turn off the FM Transmitter.
5. Press and hold **menu** to exit.

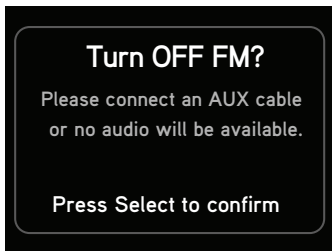
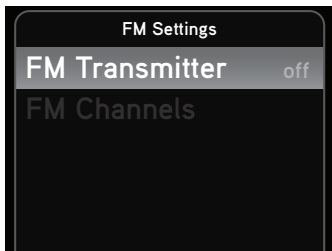

Troubleshooting

Troubleshooting

Onyx has been designed and built to be trouble-free but if you experience a problem, try this:

- Check that all connections are firm and secure.
- Make sure the vehicle power socket is clean and free of corrosion.
- Make sure you have connected the Onyx as described in this User Guide. Verify that the *PowerConnect Power Adapter* is plugged into the vehicle's cigarette lighter or power adapter socket, and that the LED on the *PowerConnect Power Adapter* is lit (on). If not, your vehicle may need to be running to provide power to the socket.

If you see this on the screen:	Try this:
Acquiring Signal	<ul style="list-style-type: none">• Make sure that the vehicle is outdoors with a clear view of the sky.• Make sure the Magnetic Mount Antenna is mounted outside of the vehicle.• Move the antenna away from any obstructed area. For example, if you are parked in an underground garage, you should receive a signal after leaving the garage.• If you are using Onyx at home, move the antenna to a south-facing window. Don't know which way is south? No problem. Start at any window then work from window to window in a simple pattern to find the best location.

If you see this on the screen:	Try this:
Check Antenna Connection	<ul style="list-style-type: none"> • Make sure that the antenna cable is firmly and securely plugged into the <i>PowerConnect Vehicle Dock</i>. Make sure the cable is not bent or broken. • Turn Onyx Off, then On, to reset this message. • If the message persists, most likely the Magnetic Mount Antenna cable has been damaged. Replace the antenna.
Channel Off Air	<ul style="list-style-type: none"> • The channel you've selected is not currently broadcasting. Tune to another channel.
Loading	<ul style="list-style-type: none"> • Your Onyx is acquiring audio or program information. This message usually goes away in a few seconds.
Updating	<ul style="list-style-type: none"> • Your Onyx is updating with the latest encryption code. Wait until the update is done. • You may be trying to tune to a channel that is blocked or unavailable. Tune to another channel.
–	<ul style="list-style-type: none"> • No program information, such as artist name, song title, or channel exists.
If this happens:	Try this:
You do not receive all the channels to which you subscribed	<ul style="list-style-type: none"> • Ensure that you have activated your service by following the steps in "Activation" on page 50. • Go to www.siriusxm.ca and follow the directions refresh your radio. • Call 1-877-438-9677 for further assistance.

Troubleshooting

If this happens:	Try this:
No audio when using the Aux In Cable or Cassette Adapter	<ul style="list-style-type: none">• Check all cables between your Onyx and your vehicle's stereo system for a firm and secure connection.• Ensure you have selected the proper input source on your vehicle's stereo system.• If you are using the Vehicle Dock that came with the Universal Xpress Car Kit, ensure that the FM Transmitter in the Onyx is turned Off, and increase the audio level of the Onyx. Refer to "Set Audio Level" on page 80.
Audio sounds too soft	<ul style="list-style-type: none">• Raise the volume of your stereo system or increase the audio level of your Onyx until the sound quality improves. Refer to "Set Audio Level" on page 80.
Audio fades or has static when listening	<ul style="list-style-type: none">• Check all cables for a firm and secure connection.• If you are using <i>PowerConnect</i> to listen via your vehicle's FM radio, and the problem persists, it most likely is interference from another commercial or broadcast FM station. You will need to find an unused or available FM channel in your area. Refer to "Find Available FM Channels in Your Area" on page 73.• If you are using <i>PowerConnect</i>, and you cannot solve the audio problem, try connecting the audio using the Aux In Cable or a Cassette Adapter. (Refer to page 39 and page 41.) If you cannot use those solutions, consider using an FM Direct Adapter. (Refer to page 47.)

If this happens:	Try this:
No audio when using PowerConnect or FMDA	<ul style="list-style-type: none"> • Check that your Onyx and your vehicle's FM radio are tuned to the same FM channel. • If you are using the Vehicle Dock that came with the Universal Xpress Car Kit, ensure that the FM Transmitter in the Onyx is turned On. Refer to "Turn FM Transmitter On/Off" on page 88 .
No song title or artist name is displayed	<ul style="list-style-type: none"> • The information may not be available or updates may be in progress.
The demo is playing	<ul style="list-style-type: none"> • Your Magnetic Mount Antenna is not connected or you are not receiving the signal. Check that the antenna is connected properly and is not obstructed. • Press and hold the Select button for 10 seconds to exit Demo Mode. • You can disable Demo Mode. Refer to "Demo Mode" on page 85.

Product Specifications

Product Specifications

Dimensions

Onyx 115 mm (W) X 61 mm (H) X 18 mm (D)
4.5 in (W) X 2.4 in (H) X 0.71 in (D)

Weight

Onyx 93 g (3.28 oz)

Audio Outputs

3.5 mm diameter mini stereo jack

External Power

Voltage 5V DC
Current 1.5A

Patent and Environmental Information

Patent Information

It is prohibited to, and you agree that you will not, copy, decompile, disassemble, reverse engineer, hack, manipulate, or otherwise access and/or make available any technology incorporated in this product. Furthermore, the AMBE[®] voice compression software included in this product is protected by intellectual property rights including patent rights, copyrights, and trade secrets of Digital Voice Systems, Inc. The software is licensed solely for use within this product. The music, talk, news, entertainment, data, and other content on the Services are protected by copyright and other intellectual property laws and all ownership rights remain with the respective content and data service providers. You are prohibited from any export of the content and/or data (or derivative thereof) except in compliance with applicable export laws, rules and regulations. The user of this or any other software contained in an XM radio is explicitly prohibited from attempting to copy, decompile, reverse engineer, hack, manipulate or disassemble the object code, or in any other way convert the object code into human-readable form.

Environmental Information

Follow local guidelines for waste disposal when discarding packaging and electronic appliances.

Your radio is packaged with cardboard, polyethylene, etc., and does not contain any unnecessary materials.

FCC and IC Statement

The user is cautioned that changes or modifications not expressly approved by XM Radio Inc. can void the user's authority to operate this device.

This device complies with Part 15 of the FCC Rules and is certified to Industry Canada's RSS-210 specifications. Operation is subject to the following two conditions:

1. This device may not cause harmful interference.
2. This device must accept any interference received, including interference that may cause undesired operation.

This equipment has been tested and found to comply with the limits for a Class B digital device, pursuant to Part 15 of the FCC Rules and Industry Canada's RSS-210 specifications. These limits are designed to provide reasonable protection against harmful interference in a residential installation.

This equipment generates, uses, and can radiate radio frequency energy and, if not installed and used in accordance with the installation instructions, may cause harmful interference to radio communications. However, there is no guarantee that interference will not occur in a particular installation. If this equipment does cause harmful interference to radio or television reception, which can be determined by turning the equipment off and on, the user is encouraged to try to correct the interference by one or more of the following measures:

- Reorient or relocate the receiving antenna of the affected receiver.
- Increase the separation between the XM equipment and the affected receiver.
- Connect the XM equipment into an outlet on a circuit different from that to which the affected receiver is connected.
- Consult the dealer or an experienced radio/TV technician for help.

WARNING! The FCC and FAA have not certified this Satellite Radio Receiver for use in any aircraft (neither portable nor permanent installation). Therefore, XM Radio Inc. cannot support this type of application or installation.

Copyrights and Trademarks

© 2012 Sirius XM Canada Inc. "SiriusXM", the SiriusXM logo, channel names and logos are trademarks of Sirius XM Radio Inc. and are used under license. "NFL" and the NFL Shield design are trademarks of the National Football League. NASCAR® is a registered trademark of the National Association for Stock Car Auto Racing, Inc. The NBA and NBA member team identifications are the intellectual property of NBA Properties, Inc. and the respective NBA member teams. © 2012 NBA Properties, Inc. All rights reserved. NHL and the NHL Shield are registered trademarks of the National Hockey League. © NHL 2012. Elvis Radio logo © EPE Reg. U.S. Pat & TM off. CFL® is a registered trademark of the Canadian Football League. All other trademarks, service marks, images and logos are property of their respective owners and are used with permission. All Rights Reserved. Required subscription sold separately. Premier subscription required for some channels. Prices and programming is subject to change. See Customer Agreement for complete terms at siriusxm.ca.

Owners Record

Owner's Record

The radio model number is located below and the XM Radio ID is located on the label on the back of the Onyx.

Record the XM Radio ID in the space provided below. Refer to these numbers whenever you call your dealer regarding this product.

Radio Model Number: XDNX1V1KC

XM Radio ID: _____

www.siriusxm.ca

**Sirius XM Canada Inc.
135 Liberty St. - 4th floor
Toronto, Ontario, M6K 1A7**

1-877-438-9677

© 2012 Sirius XM Canada Inc.

Onyx User Guide 120830a