



**User Guide**

**Home Kit For Sirius Radios**



# Table of Contents

<b>Introduction</b> .....	<b>5</b>
Features .....	6
Safety and Care Information .....	7
Warnings .....	7
What's in the Box? .....	8
Connections .....	9
<b>Home Installation</b> .....	<b>11</b>
Step 1: Connect the Home Dock .....	12
Step 2: Install the Indoor/Outdoor Antenna .....	17
<b>Troubleshooting</b> .....	<b>21</b>
<b>Product Specifications</b> .....	<b>25</b>
Patent Information .....	27
Environmental Information .....	27





# Introduction

## Features

**Congratulations on the purchase of your new home kit for Sirius radios.**

The Home Kit lets you enjoy your favourite SiriusXM programming through your home audio system.

Compatible with the Sportster 3/4/5/6, Starmate 3/4/5/6/7/8, Stratus 3/5/6/7, Streamer 3/GT3/GT5.

## Safety and Care Information

Be sure to observe the following warnings. Failure to follow these safety instructions and warnings may result in a serious accident and/or personal injury.

- Installation must be performed according to this installation guide. SIRIUS is not responsible for issues arising from installations not performed according to the procedures in this guide.
- Use only the provided AC Power Adapter.
- Do not install the unit where it will be exposed to high levels of humidity, moisture, or dust.
- To avoid short circuits, do not open the unit, and never put or leave any metallic objects (coins, tools, etc.) inside the unit.
- If the unit emits smoke or unusual odors, turn the power off immediately, and disconnect the unit from any power source.
- Do not drop the unit or subject it to strong shocks.
- The installation and use suggestions contained in this manual are subject to any restrictions or limitations that may be imposed by applicable law. The purchaser should check applicable law for any restrictions or limitations before installing and/or operating this unit.

## Warnings

### Cleaning and Maintenance

If the home dock becomes dirty, turn the power off and wipe it clean with a soft cloth. Do not use hard cloths, strong cleaning fluids, paint thinner, alcohol, or other volatile solvents to clean. These may cause damage to the unit.

# Introduction

## What's in the Box?

The following items are included with your purchase of the Home Kit. Unpack the kit carefully and make sure that everything shown is present. If anything is missing or damaged, or if the kit fails to operate properly, notify your dealer immediately. It is recommended that you retain the original carton and packing materials in case you need to ship your kit in the future.

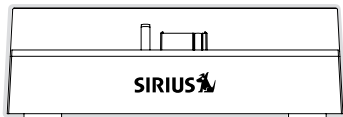

Home Dock

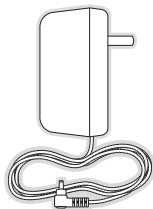

AC Adapter



Audio Cable



Indoor/Outdoor Home  
Antenna



Home Dock Spacer



## Connections

The following identifies and describes the connectors of the home dock.

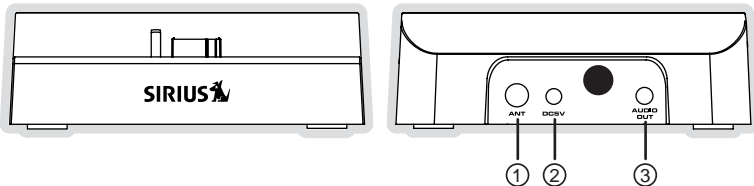

1. **ANT Antenna Connector:** Connection for the satellite antenna.
2. **DC5V Power Connector:** Power connection for the AC Power Adapter.
3. **AUDIO OUT Connector:** Audio output connection for connecting to your home entertainment system, or amplified speakers.



# Home Installation

# Home Installation

There are two parts to setting up your Home Kit. First, connecting the Home Dock to your stereo or powered speakers, then placing and aiming the Home Antenna. Let's start with getting your Home Dock set up.

## Step 1: Connect the Home Dock

When installing the Home Dock in your home, choose a location in close proximity to your home stereo system or powered speakers, and also where the cable from the Indoor/Outdoor Antenna can reach the Home Dock. The location should be easily accessible and provide good visibility of the display, but should not be located where it will be in direct sunlight, which will affect the visibility of the display screen.

You will also need to decide whether you will be connecting your Home Dock to your home stereo system using the provided Stereo Audio Cable, or directly to powered speakers.

### Connect the Indoor/Outdoor Antenna

Once you have selected a location, connect the antenna to the **ANT** connector at the rear of the Home Dock. (After completing a few additional steps, we will work on the location of the antenna.)

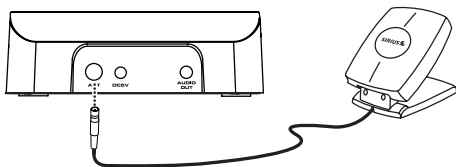

## Connect the Home Power Adapter

Connect the Home Power Adapter to the **DC5V** connector at the rear of the Home Dock, and plug it into a wall outlet.

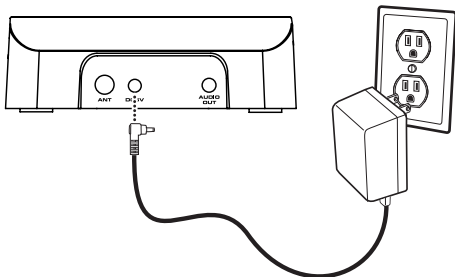

## Connect the Home Dock to a Home Stereo System or Powered Speakers

The Home Dock can be connected to your home stereo system, or to a pair of powered speakers. If you are connecting to a home stereo system, see the following section. If you are connecting to a pair of powered speakers, see "To Connect the Home Dock to Your Powered Speakers" on page 15.

### *To Connect the Home Dock to Your Home Stereo System*

The Home Dock can be connected to your home stereo system through the AUX IN or LINE IN connection of your home stereo system, using the provided Stereo Audio Cable.

# Home Installation

1. Take the provided Stereo Audio Cable and connect the single 3.5 mm (1/8") connector to the **AUDIO OUT** connector at the rear of the Home Dock.
2. Connect the white left and red right Stereo Audio Cable connectors ("L" and "R" are also on each respective tip) to any available input other than PHONO on your home stereo system. (If your stereo's inputs are marked red and black, simply connect the white plug to the black input.)
3. Turn the home stereo system On, and make sure you select the correct input on your stereo system for the **AUX In** or **LINE In** connection.

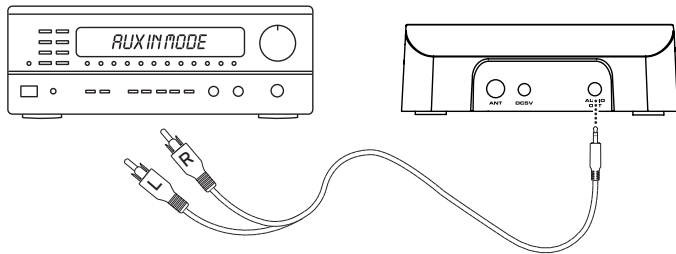

### ***To Connect the Home Dock to Your Powered Speakers***

The Home Dock can be connected directly to a pair of powered speakers.

1. Connect the 3.5 mm (1/8") connector from the powered speakers to the **AUDIO OUT** connector at the rear of the Home Dock.

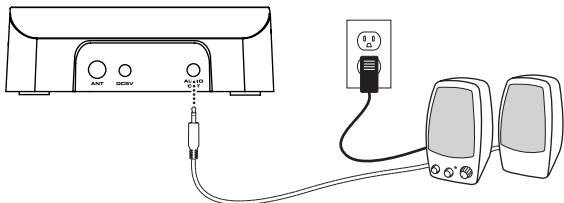

2. Plug the powered speakers into an AC outlet.
3. Turn On the powered speakers.

# Home Installation

## Dock Your Radio

If your radio is a plug and play model other than the Sportster™ 3 or Sportster 4, you may need to install the spacer on the home dock. To install the spacer, peel the backing off the adhesive strip on the rear of the spacer and position the spacer on the home dock as shown.

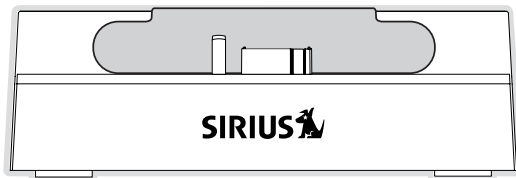

Place the radio into the home dock, aligning the connector on the radio with the connector on the home dock, and gently press the radio down until it is fully seated in the home dock. Press the power button on the radio to turn it on.



## Step 2: Install the Indoor/Outdoor Antenna

To begin, try experimenting with the Home Antenna to get a feel for the reception in your location. Move the antenna around the room or from room to room. Aim it from different windows. In major metropolitan areas, you might find that you get great reception in several locations without worrying too much about aim and placement.

Refer to your radio's User Guide for instructions, and access the **Signal** or **Signal Indicator** screen of your radio to see a visual indication of signal strength. If you're receiving a good Satellite and Terrestrial signal strength, you're done. If not, try some of the suggestions which follow.

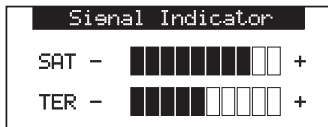

### **Other Indoor/Outdoor Antenna Installation Suggestions**

If you find you are getting a signal, but it's inconsistent, try moving the Indoor/Outdoor Antenna closer to a window, ideally one that is facing due south.

Not sure which way is south? Think about where the sun rises (in the east) and sets (in the west). Then stand so that east is to your left and you'll be facing south. Is there a

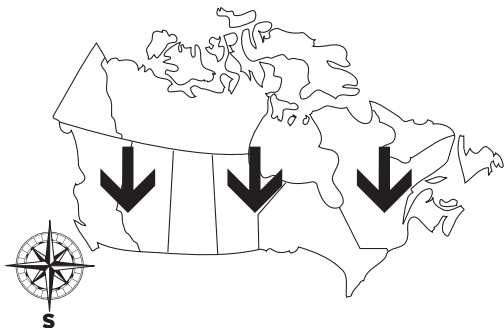

# Home Installation

window in the direction you're facing? Move the antenna closer to the window.



**TIP!** Still not sure which way is south or where to place your Home Antenna? Look up your location on an online mapping Web site that offers satellite views of street addresses where you can easily see which way is south, and what window may offer an unobstructed view of the sky.

Another easy method is to start at any window, then work from window to window in a simple pattern to find the window gives the best signal strength. Note that the antenna must also have an unobstructed view. No trees or buildings blocking its aim. If the antenna is aimed through a window, be aware that blinds, screens, or any other non-glass elements such as thermal insulation can sometimes cause reception issues. If this is the case, you may want to use another window or place the antenna outside of the window.

If you find a window that gives you good signal strength, you can place the antenna on the windowsill. The antenna may need to be placed on something to raise it above the level of the window frame.

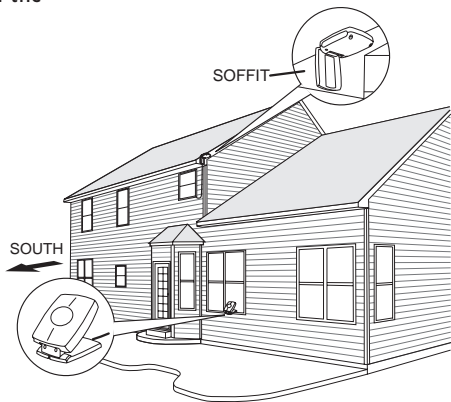
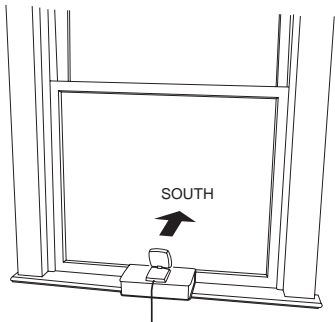

If you don't have a window where you receive a consistent signal, or placing the antenna in a window is not a practical solution for you, **BETTER** reception can be achieved by placing the antenna outside on a window ledge, porch, table, or patio. The location you choose should provide the antenna with a clear view of the southern sky.

If none of the previous solutions work for you, then the **BEST** reception can be achieved by mounting the antenna outdoors, with a clear view of the southern sky.

Note that you will want to consider any potential hazards when you choose the mounting location, and possibly consider professional installation. XM Radio Inc. is not liable for any damages.

To mount the antenna, you will need four screws (not included) with a 1/4" head (e.g., an M3 screw), and that are suitable for the material onto which you are affixing the antenna, (e.g., wood, metal, etc.). The screws should be spaced 30 mm (1-3/16") apart horizontally and 36.5 mm (1-7/16") vertically. Refer to the template on "Indoor/Outdoor Antenna Template" on page 32.

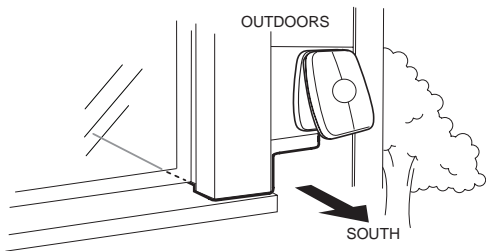

# Home Installation

Once you have found a suitable location for the antenna, route the antenna cable to the Home Dock. Be sure you avoid any obstructions that could crimp, kink, or twist the cable. Use protective grommets wherever rough openings are encountered. If the antenna is installed outdoors, route the cable from the antenna location to the interior of the home, working the cable through the basement, under a window sill, etc., and make adjustments to take up cable slack as necessary.



**TIP!** If your Indoor/Outdoor Antenna's cable isn't long enough, visit [siriusxm.ca](http://siriusxm.ca), or your favourite retailer, and consider a 15 m (50 ft.) Indoor/Outdoor Antenna Extension Cable or a Wireless Home Signal Repeater.

If the signal is good for either Satellite or Terrestrial (or both), and you are hearing the audio from the radio, the installation is complete.

If the signal reception is low, or intermittent, try another location for the antenna. Verify that the antenna is pointed south, and that the antenna's view of the sky is not blocked by a tree, a building, a bridge, or anything else. Adjust until you are receiving a good signal.

The Indoor/Outdoor Antenna's reception can also be tweaked by opening or closing the antenna clamshell, and turning the antenna. While observing the

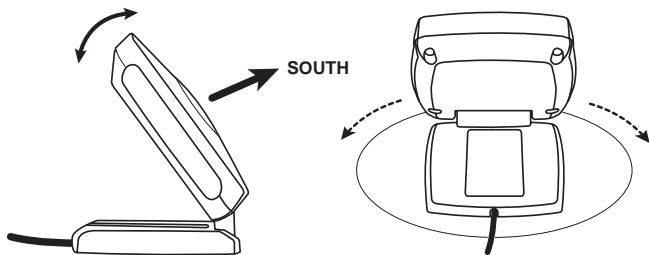

signal strength, make small adjustments to the angle of tilt of the clamshell until the highest possible signal strength is achieved. If you have not wall-mounted the antenna, turn the antenna slightly to the right or left and observe if the signal strength increases. For each tweak, allow a few seconds in each position to determine if the signal strength increases.

If the signal reception is good, but there is no audio, verify your audio connection.

- If you are connected to a home stereo system, be sure the system is set to the auxiliary input source, and you have connected the Stereo Audio Cable to the auxiliary input connectors.
- If you are connected to powered speakers, be sure the speakers are plugged into an outlet, and are turned On.

The audio level of your radio can also be increased. Refer to the User Guide which accompanied your radio and increase the audio level.

If you still have questions, for example, 'Are there any other options/things I should consider?', etc., refer to "Troubleshooting" on page 24.



# Troubleshooting

# Troubleshooting

Your Home Kit has been designed and built to be trouble-free, but if you experience a problem, try this:

- Check that all connections are firm and secure.
- Make sure you have connected the Home Dock as described in this User Guide. Verify that the AC power outlet is working.

Symptom	Solution
Radio does not power on	<ul style="list-style-type: none"><li>• AC Power Adapter is not connected, or the AC outlet into which it is plugged is not working.</li><li>• Check that the AC Power Adapter is connected to the home dock. Try plugging the AC Power adapter into a different outlet.</li></ul>
Radio displays: <i>Antenna Not Detected</i>	<ul style="list-style-type: none"><li>• The satellite antenna is not connected to the home dock.</li><li>• Check the satellite antenna connection to the home dock.</li></ul>
Radio displays: <i>Acquiring Signal</i>	<p>No satellite signal is being received.</p> <ul style="list-style-type: none"><li>• Check for obstacles over or around the satellite antenna.</li><li>• Change the location of the antenna to eliminate nearby obstacles (buildings, trees, overhangs, etc).</li></ul>
Audio static or loss of clarity	<ul style="list-style-type: none"><li>• If using connecting to your home entertainment system, check the audio cable connections.</li><li>• If using amplified speakers, check that the audio connection to the radio.</li><li>• Refer to the section, “<i>Connect the Home Dock to a Home Stereo System or Powered Speakers</i>” on page 13.</li></ul>



Symptom	Solution
No sound	<ul style="list-style-type: none"><li>• The audio cables are not correctly connected. Check the audio cables at the home entertainment system and the SIRIUS radio.</li><li>• The amplified speakers are not plugged in, or not turned on. Verify that they are plugged in and turned on.</li><li>• Refer to the section, <i>“Connect the Home Dock to a Home Stereo System or Powered Speakers”</i> on page 13.</li></ul>



# Product Specifications

# Product Specifications

Home Dock Power Requirements .....	5 Volts DC, 1.5A, Center Positive
Operation Temperature.....	-5° to +40° C (23° to 104° F)
Audio Output .....	18mW Left + 18mW Right @ 16 ohms
Signal-to-noise (S/N).....	Greater than 70dB
Home Dock Dimensions (Height x Width x Depth) .....	1.41" x 4.49" x 2.16" (3.6cm x 11.4cm x 5.5cm)
Antenna Type .....	Windowsill Indoor/Outdoor
Antenna Cable Length .....	21' (single micro-cable)
Antenna Connector Type .....	SMB
Audio Interface (Line Out) .....	1/8" / 3.5mm Stereo Jack

# Patent and Environmental Information

## Patent Information

It is prohibited to, and you agree that you will not, copy, decompile, disassemble, reverse engineer, hack, manipulate, or otherwise access and/or make available any technology incorporated in this product. The music, talk, news, entertainment, data, and other content on the Services are protected by copyright and other intellectual property laws and all ownership rights remain with the respective content and data service providers. You are prohibited from any export of the content and/or data (or derivative thereof) except in compliance with applicable export laws, rules and regulations. The user of this or any other software contained in a Sirius radio is explicitly prohibited from attempting to copy, decompile, reverse engineer, hack, manipulate or disassemble the object code, or in any other way convert the object code into human-readable form.

## Environmental Information

Follow local guidelines for waste disposal when discarding packaging and electronic appliances.

Your Home Kit is packaged with cardboard, polyethylene, etc., and does not contain any unnecessary materials.

# IC Statement

Operation is subject to the following two conditions: (1) this device may not cause interference, and (2) this device must accept any interference, including interference that may cause undesired operation of the device. For product available in the Canada market, only channel 1~11 can be operated. Selection of other channels is not possible. This device and its antenna(s) must not be co-located or operation in conjunction with any other antenna or transmitter. To reduce potential radio interference to other users, the antenna type and its gain should be so chosen that the equivalent isotropically radiated power (e.i.r.p) is not more than that permitted for successful communication. IC Radiation Exposure Statement: This equipment complies with IC RSS-102 radiation exposure limits set forth for an uncontrolled environment. This equipment should be installed and operated with minimum distance 20cm between the radiator & your body.

**WARNING!** The FCC and FAA have not certified this Satellite Radio Receiver for use in any aircraft (neither portable nor permanent installation). Therefore, SiriusXM cannot support this type of application or installation.

# Copyrights and Trademarks

© 2012 Sirius XM Canada Inc. "SiriusXM", the SiriusXM logo, channel names and logos are trademarks of Sirius XM Radio Inc. and are used under license. "NFL" and the NFL Shield design are trademarks of the National Football League. NASCAR® is a registered trademark of the National Association for Stock Car Auto Racing, Inc. The NBA and NBA member team identifications are the intellectual property of NBA Properties, Inc. and the respective NBA member teams. © 2012 NBA Properties, Inc. All rights reserved. NHL and the NHL Shield are registered trademarks of the National Hockey League. © NHL 2012. Elvis Radio logo © EPE Reg. U.S. Pat & TM off. CFL® is a registered trademark of the Canadian Football League. All other trademarks, service marks, images and logos are property of their respective owners and are used with permission. All Rights Reserved. Required subscription sold separately. Premier subscription required for some channels. Prices and programming is subject to change. See Customer Agreement for complete terms at [siriusxm.ca](http://siriusxm.ca).

# Indoor/Outdoor Antenna Template

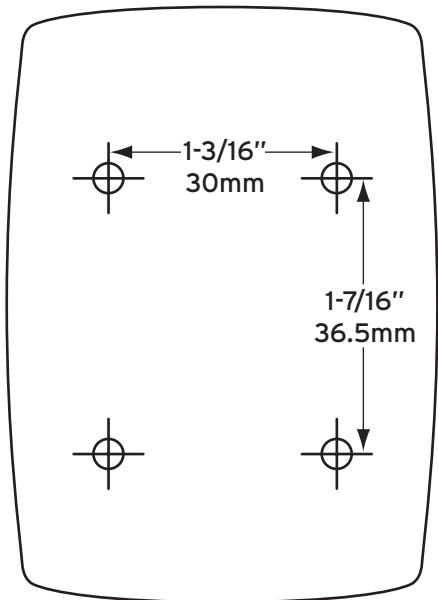





**[www.siriusxm.ca](http://www.siriusxm.ca)**

**Sirius XM Canada Inc.  
135 Liberty St. - 4th floor  
Toronto, Ontario, M6K 1A7**

**1-888-539-SIRIUS (7474)**

© 2012 Sirius XM Canada Inc.

SUPH1C 120727a