



User Guide

Vehicle Kit For Sirius Radios

Table of Contents

Introduction	5
Features	6
Safety and Care Information	7
What's in the Box?	9
PowerConnect+ Vehicle Dock	10
Vehicle Installation	11
Step 1: Choose a Location for Your Radio	12
Step 2: Install the Dash or Window Mount	14
Step 3: Mount the Magnetic Mount Antenna	18
Step 4: Route the Magnetic Mount Antenna Cable	25
Step 5: Connect the Magnetic Mount Antenna and PowerConnect+ Power Adapter	36
Step 6: Connect the Audio	37
Appendix: How To Find Available FM Channel	45
Troubleshooting	49
Product Specifications	53
Patent Information	55
Environmental Information	55

Introduction

Features

Congratulations, on your purchase of the Vehicle Kit!

The Vehicle Kit lets you easily move your SiriusXM Radio to a second vehicle so you can enjoy your favourite programming in whichever vehicle you choose to drive.

Compatible with the Sportster 5/6, Starmate 3/4/5/6/7/8, Stratus 3/5/6/7, Streamer 3/GT3/GT5.

For the latest information about this and other SiriusXM products and accessories, visit www.siriusxm.ca or your local retailer.

Safety and Care Information



IMPORTANT! Always read and understand all the instructions to avoid injury to yourself and/or damage to your device. Sirius XM Canada Inc. disclaims all responsibility for damage from data loss due to breakdown, repair, or other causes.

- Do not expose to extreme temperatures (above 140°F or below -4°F, or above 60°C or below -20°C).
- Do not expose to moisture. Do not use device near or in water. Do not touch the device with wet hands
- Do not let any foreign matter spill into device.
- Do not store in dusty areas.
- Do not expose to chemicals such as benzene and thinners. Do not use liquid or aerosol cleaners. Clean with a soft damp cloth only.
- Do not expose to direct sunlight for a prolonged period of time, and do not expose to fire, flame, or other heat sources.
- Do not try to disassemble and/or repair device yourself.
- Do not drop your device or subject it to severe impact.
- Do not place heavy objects on device.
- Do not subject device to excessive pressure.

Introduction

WARNING!

- Opening the case may result in electric shock.
- Make sure that you insert the *PowerConnect+* Power Adapter's plug all the way into the outlet.
- For optimal audio performance, insert the *PowerConnect+* Power Adapter directly into your vehicle's cigarette lighter/power outlet. Don't use an intermediary device, such as a dual vehicle power adapter for multiple devices.
- When using this product, it is always important to keep your eyes on the road and hands on the wheel. Not doing so could result in personal injury, death, and/or damage to your device, accessories, and/or to your vehicle or other property.
- Vehicle installation and Radio configuration functions should not be performed while driving. Park your vehicle in a safe location before beginning installation.

Your device should be placed in your vehicle where it will not interfere with the function of safety features, e.g., deployment of airbags. Failure to correctly place device may result in injury to you or others, if the unit becomes detached during an accident and/or obstructs the deployment of an airbag.

What's in the Box?

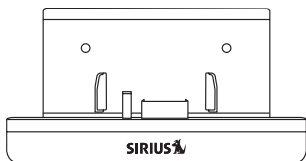

PowerConnect+ Vehicle Dock

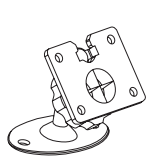

Dash Mount

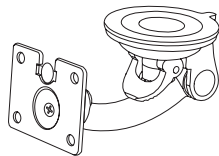

Window Mount



Aux In Cable

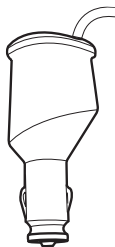

PowerConnect+
Power Adapter

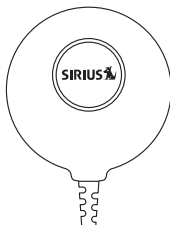

Magnetic Mount Antenna
and Tail



Screws



Alcohol
Preparation Pads

Introduction

PowerConnect+ Vehicle Dock

Color-Coded Connections

The color-coded *PowerConnect+* Vehicle Dock makes it simple to connect, just match the colors on the cable ends to the colors on the dock to see what goes where.

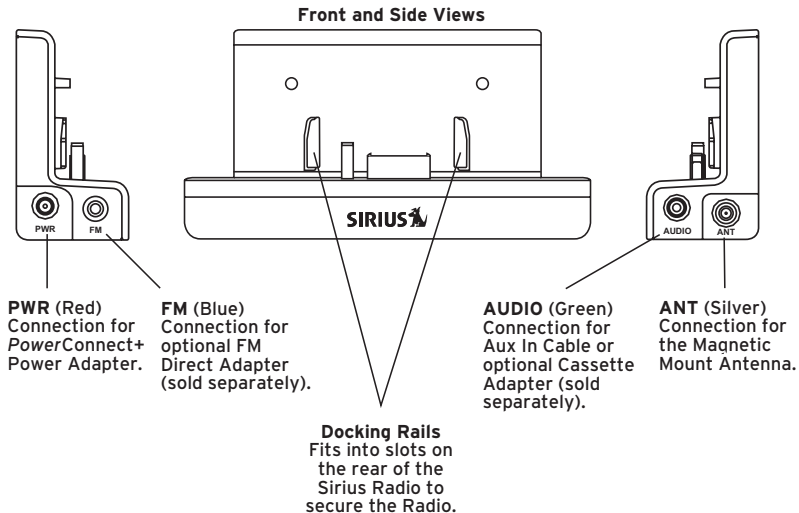

Vehicle Installation

Vehicle Installation

Step 1: Choose a Location for Your Radio

Before you begin, you may want to have the User Guide for your Satellite Radio handy, as there are a couple of steps where we suggest you reference it. If you do not have the User Guide, go to siriusxm.ca, click on **ACTIVATE**, then **INSTALLATION SUPPORT**, and then **VIEW USER GUIDES**. Click on the **User Manual** link for your Radio.

When installing the *PowerConnect+* Vehicle Dock (included in this Kit) in your vehicle, choose a location where it will not block your vision, interfere with the controls, or obstruct the air bag. The location should be easily accessible and provide good visibility of the display, and should not be located where it will be in direct sunlight, which will affect the visibility of the display screen.

Here are some examples of the dock (with a Radio) mounted using either the Dash Mount or the Window Mount.

DASH MOUNT - Option 1

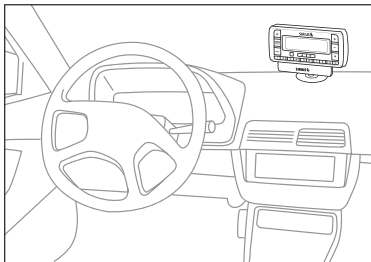

DASH MOUNT - Option 2

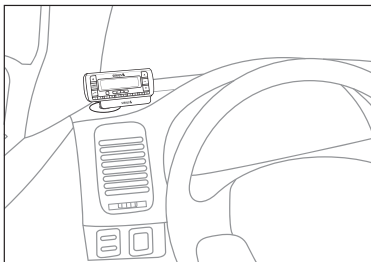

DASH MOUNT - Option 3

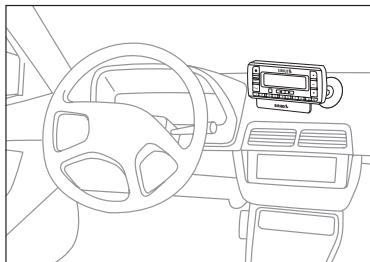

WINDOW MOUNT - Option 1

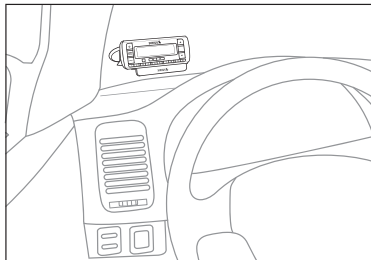

WINDOW MOUNT - Option 2

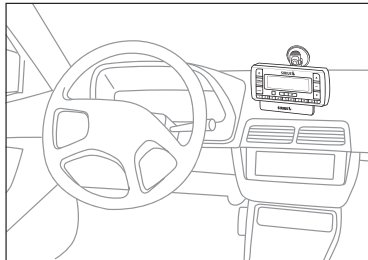

Vehicle Installation

Step 2: Install the Dash or Window Mount

Depending on your situation, you can either choose to use the Dash Mount or the Window Mount.

Installing the Dash Mount:



CAUTION! The adhesive used on the Dash Mount may be difficult to remove. Do not install this mount on leather surfaces (contact your automobile dealership if you are unsure about your dash surface), and make sure the air temperature is at least 60° F (15° C) during installation. If it's not at least 60° F, turn on the heater in your vehicle to bring the temperature up to 60° F.

- 1 Locate a flat surface for the Dash Mount. Make sure there is ample room for the *PowerConnect+* Vehicle Dock and Radio when installed.
- 2 Set the orientation of the Dash Mount before adhering it. Loosen the knob and adjust the adhesive foot for the location you selected in "Step 1:

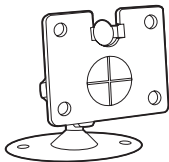

DASH MOUNT - Option 1 and DASH MOUNT - Option 2 should be oriented like the image above.

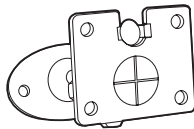

DASH MOUNT - Option 3 should be oriented like the image above.

Choose a Location for Your Radio" on page 12.

- 3 Attach the Dash Mount to the *PowerConnect+ Vehicle Dock* using the provided screws.
- 4 Clean the surface with the alcohol preparation pad and let it dry thoroughly.
- 5 Peel off the adhesive liner. Position, press, and hold the Dash Mount and *PowerConnect+ Vehicle Dock* in place for 30 seconds.



IMPORTANT! Allow the Dash Mount adhesive to cure (dry) for at least 24 hours before using the mount.

- 6 The dock mounting plate can be tilted in different directions. Adjust as necessary for your particular vehicle. When the orientation is correct, tighten the knob.

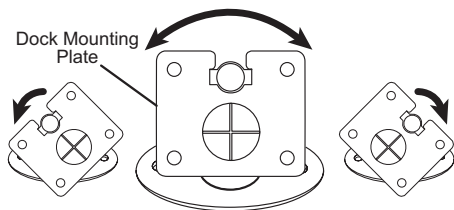
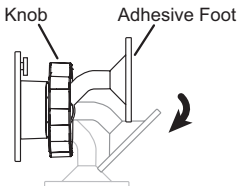
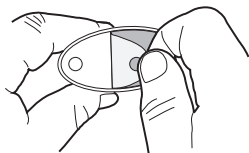
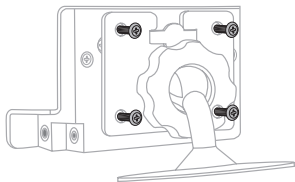

Vehicle Installation



TIP! To remove, carefully lift the adhesive pad with your fingers or a spoon. Warming the pad with a hair dryer for several minutes will help soften the adhesive. Be careful not to overheat the surface with the hair dryer or you may damage the surface or Dash Mount.

Installing the Window Mount:

- 1** Locate a place on the windshield for the mount. Make sure there is ample room for the *PowerConnect+* Vehicle Dock and Radio when installed, and that it does not block the driver's vision or any airbag. (Airbag locations are typically marked with "SRS" logos.)
- 2** Clean the surface with the alcohol preparation pad and let it dry thoroughly.
- 3** Attach the Window Mount to the *PowerConnect+* Vehicle Dock using the provided screws.

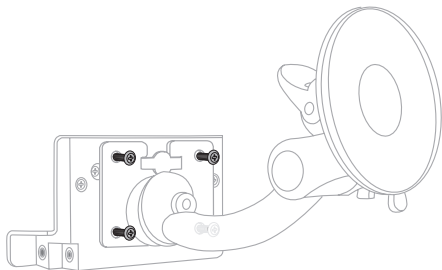



IMPORTANT! For clarity, the illustrations on this page do not show the dock attached to the mount. However, the dock should already be attached as shown in step 3.

- 4 Press and hold the mount against the windshield. Then press the lever all the way down to attach the Window Mount to the windshield.
- 5 Loosen the knob on the Window Mount to adjust the height of the Radio for the best view. Once the height is correct, tighten the knob. The dock mounting plate can be swiveled to the left or right, and adjusted up or down, to optimize the driver's view of the Radio.

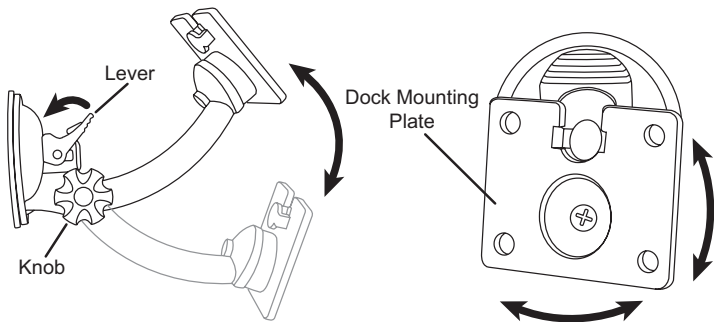
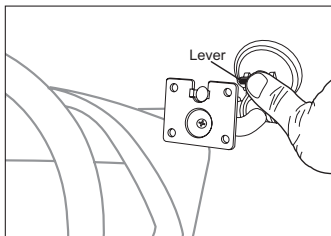

Vehicle Installation

Step 3: Mount the Magnetic Mount Antenna

The Magnetic Mount Antenna contains a strong magnet which will stick to any metal part of your vehicle, but will not damage the vehicle.

To install the Magnetic Mount Antenna:

- 1 Choose the best location for your Magnetic Mount Antenna considering your vehicle type. Pay particular attention to any accessories that you may have like luggage racks and how frequently you may use them.

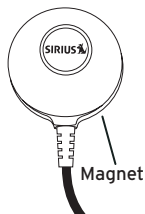

Sedan/Coupe: We recommend mounting the antenna just above either the front windshield or the back window as shown.

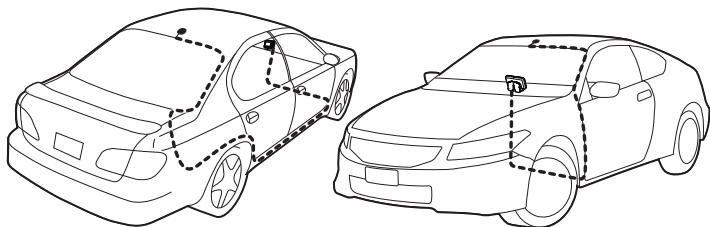

SUV: We recommend mounting the antenna at the rear of the roof as shown.

Convertible: We recommend mounting the antenna at the leading edge of the trunk as shown.

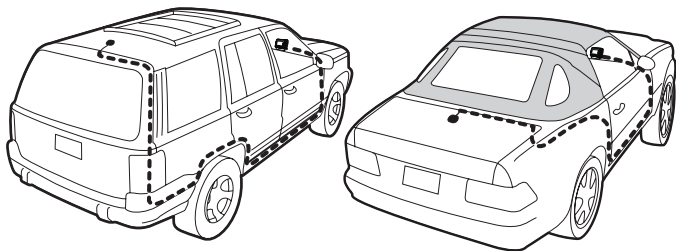

Pickup Truck: We recommend mounting the antenna just above the front windshield as shown.

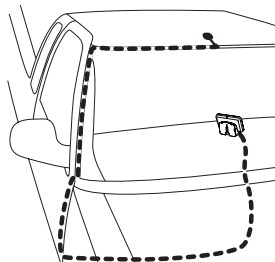

Vehicle Installation

- 2 Attach the Rubber Tail to the antenna and press the antenna cable into the Rubber Tail. The Rubber Tail will help to position the antenna the correct distance from the edge of the roof or trunk lid.
- 3 Clean the surface of the selected mounting location using the alcohol preparation pad and let it dry thoroughly.
- 4 Follow the Tips and Cautions shown on the next several pages, and place the antenna in the location you selected. Peel the protective material from the adhesive strips and press the Rubber Tail firmly into place on the vehicle.
- 5 Continue to press firmly down on the Rubber Tail for another 30 seconds. At room temperature (68° F), maximum adhesion usually occurs within 72 hours. During this period, avoid car washes and other contact with the antenna and the Rubber Tail.

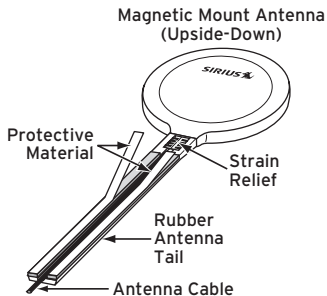

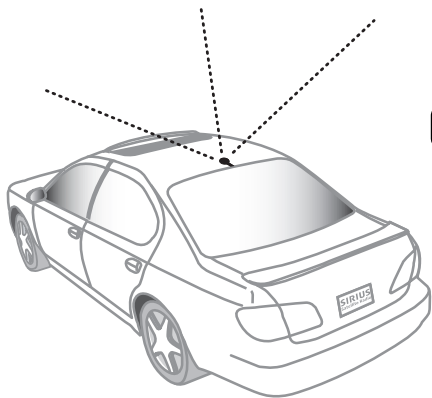

TIP! Mount the antenna on the roof (for most vehicles) or trunk (for convertibles) where it has a clear view of the sky in all directions.

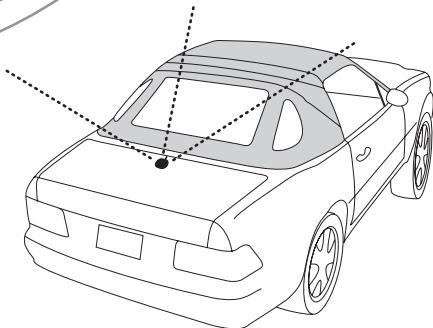

Vehicle Installation



TIP! Mount the antenna on the roof where it has at least 3 inches of clear space around it.

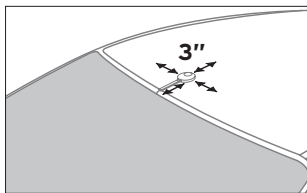

TIP! Use the supplied Rubber Tail to cover and protect the antenna cable.

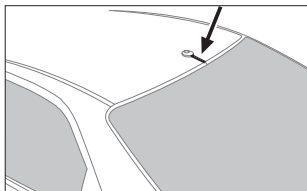

CAUTION! Don't mount the antenna closer than 3 inches from the edge of the roof. Use the supplied Rubber Tail as a guide for judging proper length and correct positioning.

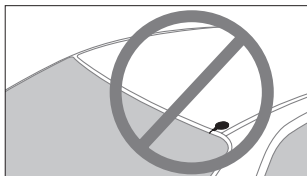



CAUTION! Don't mount the antenna inside the vehicle, for example, on the dashboard.

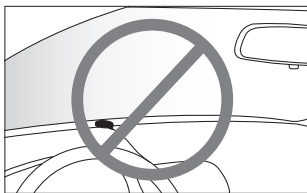

CAUTION! Don't mount the antenna on any of the vehicle's front, back or side pillars.

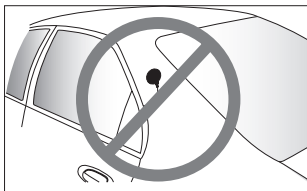

CAUTION! Don't mount the antenna close to a roof rack. Adjust the rack so it's further away from the antenna or move the antenna closer to the center of the roof.

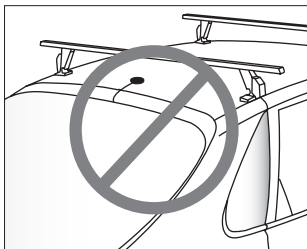

Vehicle Installation



CAUTION! Don't mount the Magnetic Mount Antenna close to another antenna. Mount it at least 3 inches away.

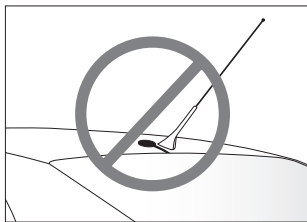

TIP! Always be careful to include enough slack in your cable to accommodate open doors or trunk lids. Use things typically found around the home, like electrical tape, to secure cables in areas so that hinges do not pinch the cable with the door. Hide any excess cable in the trim.

Step 4: Route the Magnetic Mount Antenna Cable

Before you begin routing the antenna cable, read these general instructions for how to route and hide the antenna cable. Then route your antenna cable according to the instructions which follow for your specific type of vehicle.

Use a blunt plastic putty knife, a credit card, a plastic knife, or a similar blunt tool to lift the rubber window moulding

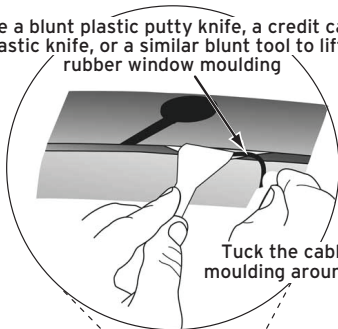

Tuck the cable under the moulding around the window

Feed cable under rubber moulding around window

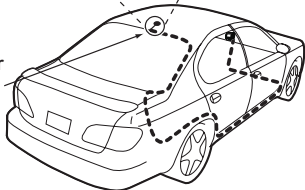

Vehicle Installation

Route cable out from under rear windshield moulding and tuck into weatherstripping around trunk opening

Avoid sharp bends by running cable through weatherstripping for several inches



Pull weatherstripping from trunk opening



Tuck cable into weatherstripping. Route cable through weatherstripping several inches to avoid sharp bends

Pull cable out of weatherstripping and route through trunk to cabin

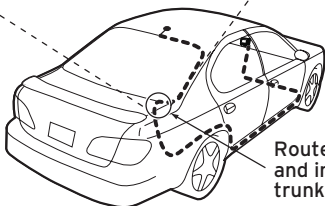
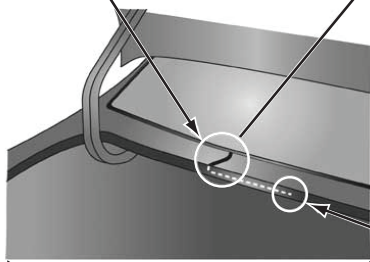

Route cable out of window moulding and into weatherstripping around trunk opening

Bring cable out of weatherstripping and into trunk

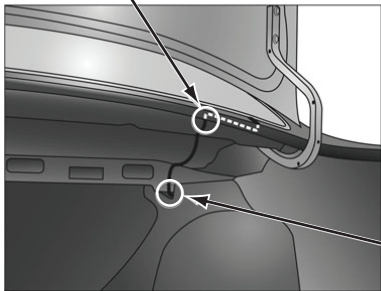

Route cable along trunk wall and into cabin through gap or conduit, along existing wiring harness

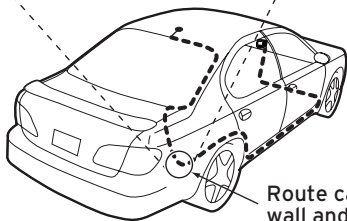

Route cable along trunk wall and into cabin

Vehicle Installation

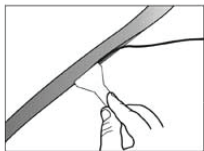

Use a blunt plastic putty knife or similar blunt tool trim and tuck cable under trim. Continue towards front of vehicle

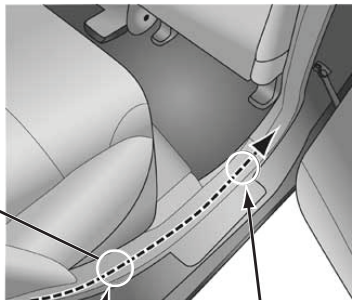

Route cable under trim or upholstery

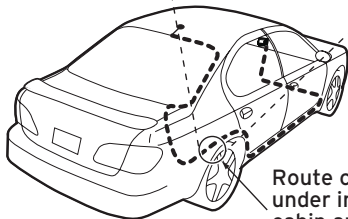

Route cable from trunk under interior trim, into cabin and towards front of vehicle

Continue routing cable under trim or carpet towards front of vehicle

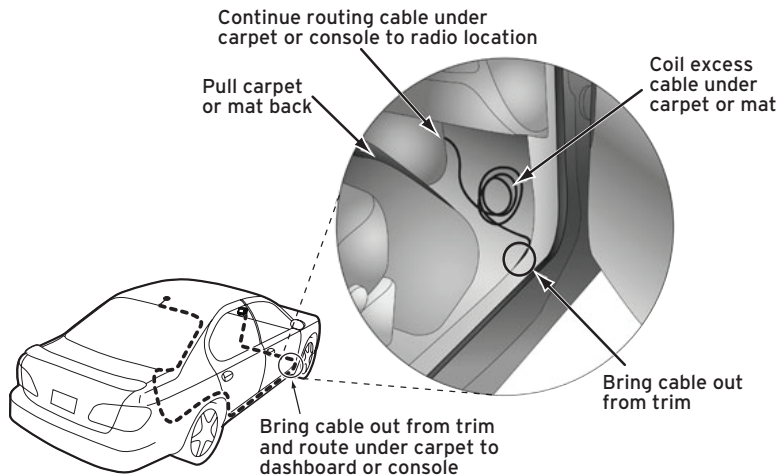

TIP! Always be careful to include enough slack in your cable to accommodate open doors or trunk lids. Use things typically found around the home, like electrical tape, to secure cables in areas so that hinges do not pinch the cable with the door. Hide any excess cable in the trim.

Vehicle Installation

• Sedan/Coupe With Antenna Placed at the Rear of the Roof:

1. Feed the antenna cable from the antenna underneath the rubber molding around the rear window. Use a blunt plastic putty knife or similar blunt tool to lift the rubber molding around the rear window and tuck the antenna cable underneath the molding. Route the antenna cable around and down the window to the lowest point. If your rear window does not have rubber molding, we recommend consulting a professional installer.
2. Route the antenna cable out of the window molding and into the rubber weather stripping around the trunk opening. Lift the weather stripping from the opening and tuck the cable inside it, then replace the weather stripping. To avoid sharp bends in the cable, run the cable inside the weather stripping for a few inches, then remove the cable from the weather stripping inside the trunk. Keep the cable away from hinges, gears, etc., that could damage it.
3. Route the cable out from the rubber weather stripping and along the trunk wall. Continue routing the cable into the vehicle cabin through a conduit or along an existing wiring harness.
4. Route the cable through the main cabin area under the interior trim, towards the front of the vehicle. Use a blunt plastic putty knife or similar blunt tool to lift the plastic trim just enough to tuck the cable underneath. Avoid side airbag locations on back pillars and above the doors. Airbag locations are marked with "SRS" logos. Be careful not to crimp or cut the cable.
5. Bring the cable out from the trim near the front of the cabin and route it under the carpet toward

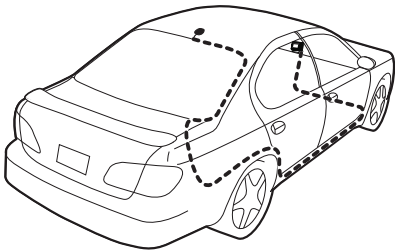

- the dashboard or console. Coil any excess cable in a hidden location, such as under the carpet, keeping it away from any vehicle pedals or controls. Secure the excess cable with wire ties (purchased separately).
6. Bring the end of the cable out at the *PowerConnect+* Vehicle Dock location. Leave yourself enough cable so you can easily connect it to the antenna connector of the dock.
 7. Continue with “Step 5: Connect the Magnetic Mount Antenna and *PowerConnect+* Power Adapter” on page 36.

Vehicle Installation

• Sedan/Coupe With Antenna Placed at the Front of the Roof:

1. Feed the antenna cable from the antenna underneath the rubber molding around the windshield. Use a blunt plastic putty knife or similar blunt tool to lift the rubber molding around the windshield and tuck the antenna cable underneath the molding. Route the antenna cable around and down the windshield to the lowest point.
2. At the lowest corner of the windshield, route the cable out of the windshield molding and into the rubber weather stripping around the door opening. Lift the weather stripping from the opening and tuck the cable inside it, then replace the weather stripping. Run the cable inside of the weather stripping to the bottom of the door opening.
3. Pull the cable out of the weather stripping at the bottom of the door opening and route it under the carpet toward the dashboard. Coil any excess cable in a hidden location, such as under the carpet, keeping it away from any vehicle pedals or controls. Secure the excess cable with wire ties.
4. Bring the end of the cable out at the *PowerConnect+ Vehicle Dock* location. Leave yourself enough cable so you can easily connect it to the antenna connector of the dock.
5. Continue with "Step 5: Connect the Magnetic Mount Antenna and *PowerConnect+ Power Adapter*" on page 36.

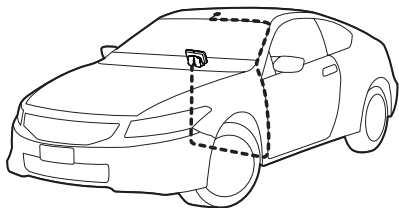

• SUV:

1. Feed the antenna cable underneath the rubber weather stripping of the rear tailgate window/door and route the cable along the rear hatch. Lift the weather stripping from the opening and tuck the cable inside it, then replace the weather stripping. Pull the cable out from weather stripping and route it into the cabin under the interior trim. Avoid hinges or gears that could crimp or cut the cable.
2. Route the cable through the SUV's main cabin area under the interior trim, towards the front of the vehicle. Use a blunt plastic putty knife or similar blunt tool to lift the plastic trim just enough to tuck the cable under underneath. Avoid side airbag locations on back pillars and above the doors. Airbag locations are marked with "SRS" logos. Be careful not to crimp or cut the cable.
3. Bring the cable out from the trim near the front of the cabin and route it under the carpet toward the dashboard or console. Coil any excess cable in a hidden location, such as under the carpet, keeping it away from any vehicle pedals or controls. Secure the excess cable with wire ties (purchased separately).
4. Bring the end of the cable out at the *PowerConnect+ Vehicle Dock* location. Leave yourself enough cable so you can easily connect it to the antenna connector of the dock.
5. Continue with "Step 5: Connect the Magnetic Mount Antenna and *PowerConnect+ Power Adapter*" on page 36.

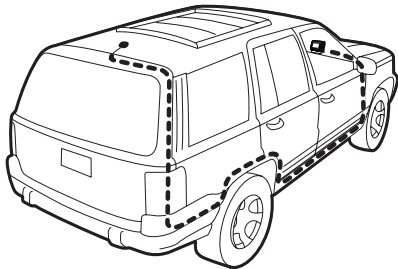

Vehicle Installation

• Convertible:

1. Bring the antenna cable from the antenna into the trunk at the front edge of the trunk lid. Keep any bends in the cable loose. Tape or tie the cable along the inside of the trunk lid to the trunk lid hinge strut.
2. Allow enough slack in the cable so the trunk lid can easily open and close and keep the cable away from hinges, gears, etc., that could crimp or cut it. Route the cable along the trunk wall and into the cabin through a conduit or along an existing wiring harness.
3. Route the cable through the main cabin area under the interior trim, towards the front of the vehicle. Use a blunt plastic putty knife or similar blunt tool to lift the plastic trim just enough to tuck the cable under underneath. Avoid side airbag locations on back pillars and above the doors. Airbag locations are marked with "SRS" logos. Be careful not to crimp or cut the cable.
4. Bring the cable out from the trim near the front of the cabin and route it under the carpet toward the dashboard or console. Coil any excess cable in a hidden location, such as under the carpet, keeping it away from any vehicle pedals or controls. Secure the excess cable with wire ties (purchased separately).
5. Bring the end of the cable out at the *PowerConnect+ Vehicle Dock* location. Leave yourself enough cable so you can easily connect it to the antenna connector of the dock.
6. Continue with "Step 5: Connect the Magnetic Mount Antenna and *PowerConnect+ Power Adapter*" on page 36.

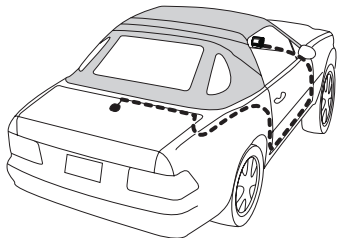

• **Pickup Truck:**

1. Use a blunt plastic putty knife or similar blunt tool to lift the rubber molding around the windshield and tuck the antenna cable underneath it.
2. Continue tucking the cable underneath the windshield molding around the windshield to the lowest corner.
3. At the lowest corner of the windshield, route the cable out of the windshield molding and into the rubber weather stripping around the door opening. Lift the weather stripping from the opening and tuck the cable inside it, then replace the weather stripping. Run the cable inside of the weather stripping to the bottom of the door opening.
4. Pull the cable out of the weather stripping at the bottom of the door opening and route it under the carpet toward the dashboard. Coil any excess cable in a hidden location, such as under the carpet, keeping it away from any vehicle pedals or controls. Secure the excess cable with wire ties.
5. Bring the end of the cable out at the *PowerConnect+ Vehicle Dock* location. Leave yourself enough cable so you can easily connect it to the antenna connector of the dock.
6. Continue with “Step 5: Connect the Magnetic Mount Antenna and *PowerConnect+ Power Adapter*” on page 36.

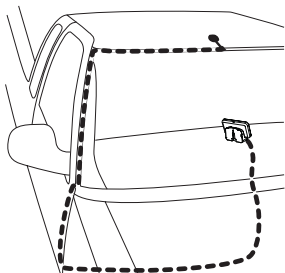

Vehicle Installation

Step 5: Connect the Magnetic Mount Antenna and PowerConnect+ Power Adapter

- 1 Plug the Magnetic Mount Antenna into the **silver ANT** connector on the right side of the PowerConnect+ Vehicle Dock.

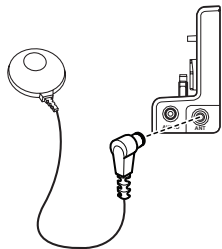

- 2 Insert the PowerConnect+ Power Adapter into your vehicle's cigarette lighter or power adapter socket.

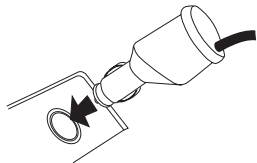

- 3 Plug the PowerConnect+ Power Adapter into the **red PWR** connector on the left side of the dock.

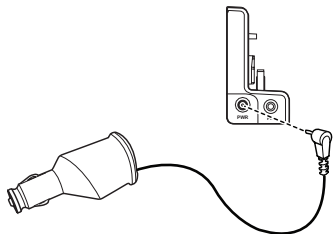

Step 6: Connect the Audio

To play audio through your vehicle's stereo or FM radio, decide on one of the following audio connection options:

- **Option 1: Best:** Use the included **Aux In Cable** if your vehicle's stereo system has an auxiliary input connection. Refer to your vehicle's owners manual to find the location of the auxiliary input jack, or consult the vehicle dealer.



TIP! The auxiliary input jack may be located on the face plate of the vehicle radio, on the back of the radio, anywhere on the front dash panel, inside the glove compartment, or inside the center console in between the front seats.

- **Option 2: Better:** Use a **Cassette Adapter** if your vehicle has a built-in cassette player. Cassette Adapters are sold separately and can be purchased from an electronics retailer, or go to siriusxm.ca.
- **Option 3: Good:** Use the **PowerConnect+** feature in the Radio. *PowerConnect+* plays the audio through your vehicle's FM radio.
- **Option 4: Best:** Use the **FM Direct Adapter**. If none of the previous three audio connection options will work in your vehicle, then you will need to use the FM Direct Adapter (FMDA) (sold separately). The FMDA needs to be installed by a professional installer and directly connects your Radio to your vehicle's FM radio. To learn more, check with the retailer where you bought your Radio, or go to www.siriusxm.ca.

Follow the installation instructions in the next several sections for the audio connection option that you have selected.

Vehicle Installation

Option 1: Aux In Cable Installation Instructions

- 1 Plug one end of the Aux In Cable into the **green AUDIO** connector on the dock.

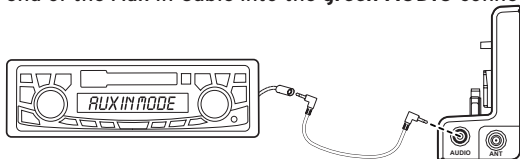

- 2 Plug the other end into the auxiliary input jack connection of your vehicle's stereo system.
- 3 Insert your Radio into the dock, aligning the Radio against the rear of the dock so that the rails on the dock fit into the mounting slots in the back of the Radio.

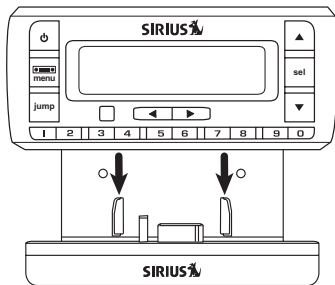

4 Power on your Radio by pressing the **Power button**.

5 Set your vehicle's stereo system to play input from the auxiliary input source.

6 Be sure the vehicle is outside and the antenna has a clear view of the sky. Verify that you are receiving the satellite signal. Refer to the User Guide which accompanied your Radio, and display the **Signal Indicator** screen. If the signal is good, and you are hearing the audio when tuned to channel 184, the installation is complete. Now sit back and enjoy SiriusXM radio.

7 The audio level output of the Radio can be increased or decreased as necessary to match the audio levels of other sources in your vehicle. Refer to the User Guide which accompanied your Radio for instructions.

If the signal reception is good, but there is no audio when tuned to channel 184, be sure the vehicle's stereo system is set to the correct source, i.e., auxiliary input source (step 5). Also be sure that the audio level is set high enough to be heard (step 7). Refer to "Troubleshooting" on page 50 for additional help.

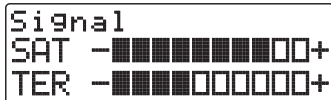
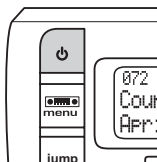

Vehicle Installation

Option 2: Cassette Adapter Installation Instructions

1 Plug the Cassette Adapter into the **green AUDIO** connector on the dock.

2 Insert the Cassette Adapter in the vehicle's cassette deck.

3 Place your Radio into the *PowerConnect+ Vehicle*

Dock, aligning the Radio against the rear of the dock so that the rails on the dock fit into the mounting slots in the back of the Radio. Slide the Radio all the way down onto the dock so that it fits firmly.

4 Power on your Radio by pressing the **Power** button.

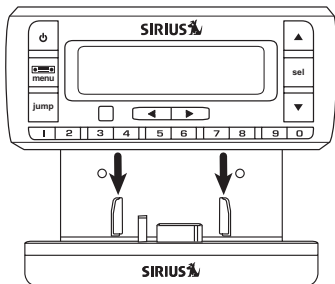
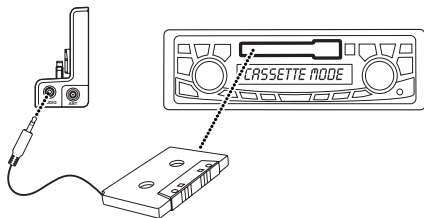

- 5 Set the vehicle's stereo system to play from the cassette source.
- 6 Be sure the vehicle is outside and the antenna has a clear view of the sky. Verify that you are receiving the satellite signal. Refer to the User Guide which accompanied your Radio, and display the **Signal Indicator** screen. If the signal is good, and you are hearing the audio when tuned to channel 184, the installation is complete. Now sit back and enjoy SiriusXM radio.

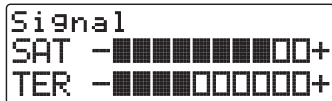
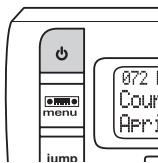

- 7 The audio level output of the Radio can be increased or decreased as necessary to match the audio levels of other sources in your vehicle. Refer to the User Guide which accompanied your Radio for instructions.

If the signal reception is good, but there is no audio when tuned to channel 184, be sure the vehicle's stereo system is set to the correct source, i.e., cassette source (step 5). Also be sure that the audio level is set high enough to be heard (step 7). Refer to "Troubleshooting" on page 50 for additional help.

Vehicle Installation

Option 3: *PowerConnect+* Installation Instructions

- 1 Place your Radio into the *PowerConnect+* Vehicle Dock, aligning the Radio against the rear of the dock so that the rails on the dock fit into the mounting slots in the back of the Radio. Slide the Radio all the way down onto the dock so that it fits firmly.
- 2 Power on your Radio by pressing the **Power** button.
- 3 Be sure the vehicle is outside and the antenna has a clear view of the sky. Verify that you are receiving the satellite signal. There should at least be one bar on main display screen that denotes antenna signal strength. You can also refer to the User Guide which accompanied your Radio, and display the **Signal Indicator** screen. The Satellite and Terrestrial bars show the strength of the signal being received. If the signal reception is good, press and hold **menu** to return to the main display screen. You are ready to make the audio connection.

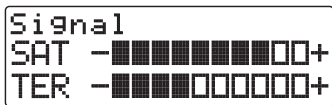
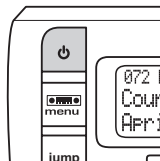
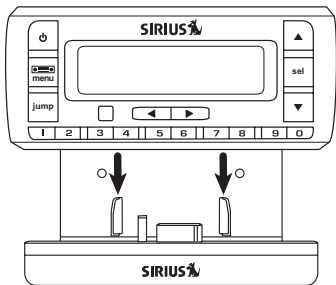

- 4 You'll first need to find an available FM channel to listen to the SiriusXM audio through your vehicle's FM radio. Refer to "How To Find Available FM Channels In Your Area" on page 46.
- 5 Ensure that the Radio is tuned to channel 184. Upon power up, the Radio should tune to channel 184 by default, when it's not yet activated. If it's not on channel 184, tune to channel 184.
- 6 Pick the first FM channel on your list from step 4. Turn on your vehicle's FM radio (if you have not already done so) and tune it to this FM channel.
- 7 Refer to the User Guide which accompanied your Radio, and set your Radio to transmit on the same usable FM channel that you found in step 4.



- 8 You should hear Sirius channel 184 through your vehicle's FM radio. If you are satisfied with the sound quality, you're done! Now sit back and enjoy SiriusXM radio.
- 9 If the selected FM channel doesn't work well for you, work down the list of FM channels until you find one that allows you to hear SiriusXM clearly. Each time, you will need to tune your vehicle's FM radio to the FM channel and then set your Radio to transmit on the same FM channel (steps 6 & 7).

If the signal reception is good, but there is no SiriusXM audio when tuned to channel 184, verify that both the Radio and your vehicle's FM radio are tuned to the same FM channel (steps 6 & 7). Also ensure the chosen FM channel is a suitable one to use in your area (step 4). Verify that nothing is plugged

Vehicle Installation

into the **AUDIO** connector on the *PowerConnect+* Vehicle Dock. Refer to “Troubleshooting” on page 50 for additional help.

Option 4: FM Direct Adapter (FMDA) Installation

The FMDA needs to be installed by a professional installer. Professional installation can help improve your Radio’s reception and significantly reduce the visibility of wires. To learn more, check with the retailer where you bought your Radio, or go to siriusxm.ca.

Your installer will help you get set up, but if you travel away from your local area, you will want to familiarize yourself with the section called “How To Find Available FM Channels In Your Area” on page 46.

Appendix: How To Find Available FM Channel

Appendix: How To Find Available FM Channel

How To Find Available FM Channels In Your Area

An available FM channel is one that is not being used by an FM radio station in your area. When you tune your FM radio to an available channel, you should only hear static or silence – not talk or music. Once you have found an available channel, you need to tune your Satellite Radio's built-in transmitter to the same channel to receive SiriusXM audio through your vehicle's radio.

We recommend one of the following methods to find an available FM channel:

1 Use the FM Frequency Finder

Use the FM Frequency Finder at www.siriusxm.ca. Go to the website and enter your postal code. The FM Frequency Finder will suggest a list of available FM channels in your area. For convenience, write down or print out the list.

Now, tune your Satellite Radio to a favourite SiriusXM channel (or to channel 184, if it's not yet activated). Turn on your vehicle's FM radio. Pick the first FM channel on your Channel Finder list and tune the FM radio to that channel. If you do not hear a local FM station broadcast, then tune your Satellite Radio to the same FM channel. (Consult your User Guide if you are unsure how to tune it to the same FM channel.) You should hear the Sirius channel through your vehicle's radio. If you are satisfied with the sound quality, you're done! If this FM channel doesn't work well for you, work down the FM Frequency Finder list until you find an FM channel that allows you to hear SiriusXM clearly.

OR

2 Manually tune through your local FM channels

Manually tune through your local FM channels on your vehicle's FM radio. Turn on your vehicle's FM radio. Start at 88.1 and use the 'Manual' tune function on your vehicle's FM radio to tune through each FM channel one-by-one (88.1 followed by 88.3 etc.) to locate channels that aren't being used by a local FM radio station. Write down each FM channel that has only static or silence on it, until you reach 107.9. Once you have created your list of available FM channels, you will need to find the one that provides the best match for your Satellite Radio.

Now, tune your Satellite Radio to a favourite SiriusXM channel (or to channel 184, if it's not yet activated). Pick the first FM channel on your list and tune the FM radio to that channel. Then tune your Satellite Radio to the same FM channel. (Consult your User Guide if you are unsure how to tune it to the same FM channel.) You should hear the Sirius channel through your vehicle's radio. If you are satisfied with the sound quality, you're done! If this FM channel doesn't work well for you, work down your list until you find an FM channel that allows you to hear SiriusXM clearly.



NOTE! You may find an FM channel with static or silence that does not work with your Satellite Radio. It is possible that some type of inaudible interference is present that prevents reception of the broadcast. Your only options are to use another FM channel or a different audio connection method.

Appendix: How To Find Available FM Channels



TIP! If you regularly drive from one location to another, such as your daily commute, you may need to use different FM channels along your route for best performance. If this is the case, we recommend saving the best FM channels as presets on your FM radio and on your Satellite Radio. Then you simply select and match the best channel for the area you are in.



TIP! It will be much more difficult to find available FM channels in large cities than in most suburban or rural locations. A direct audio connection using the Aux In Cable, Cassette Adapter, or professional installation is your best solution if you drive in or near large metropolitan areas.



NOTE! The performance of FM radios are different, based on manufacturer and vehicle style. Some may not work well with the type of FM transmitter used by your Satellite Radio. This is why we recommend a direct audio connection using the Aux In Cable or Cassette Adapter if they can be used in your vehicle. Professional installation can also resolve almost any performance issue.

Troubleshooting

Troubleshooting

Your Vehicle Kit has been designed and built to be trouble-free, but if you experience a problem, try this:

- Check that all connections are firm and secure.
- Make sure the vehicle power socket is clean and free of corrosion.
- Make sure you have connected the Radio as described in this installation guide. Verify that the *PowerConnect+* Power Adapter is plugged into the vehicle's cigarette lighter or power adapter socket and that the LED on the *PowerConnect+* Power Adapter is lit (on). If not, your vehicle may need to be running to provide power to the socket.

If you see this on the screen:	Try this:
Acquiring Signal	<ul style="list-style-type: none">• Make sure that the vehicle is outdoors with a clear view of the sky.• Make sure the Magnetic Mount Antenna is mounted outside of the vehicle.• Move your antenna away from any obstructed area. For example, if you are parked in an underground garage, you should receive a signal after leaving the garage.
No Antenna Check Antenna Connections Antenna Not Detected	<ul style="list-style-type: none">• Make sure that the antenna cable is firmly and securely plugged into the <i>PowerConnect+</i> Vehicle Dock. Make sure the cable is not bent or broken.• If the message persists, most likely the antenna cable has been damaged. Replace the antenna.

If you see this on the screen:	Try this:
Invalid Channel	<ul style="list-style-type: none"> • You have attempted to tune to a channel that you have not subscribed to, or does not exist. Select a channel to which you have subscribed.
Firmware Updating	<ul style="list-style-type: none"> • Your Radio is being updated over the air with the latest software. Wait until the update is done.
If this happens:	Try this:
You do not receive all the SiriusXM channels to which you subscribed	<ul style="list-style-type: none"> • If you have not yet activated your service, refer to the User Guide which accompanied your Radio. • Call 1-888-539-7474 for further assistance.
No audio when using the Aux In Cable or Cassette Adapter	<ul style="list-style-type: none"> • Check all cables between your Radio and your vehicle's stereo system for a firm and secure connection. • Ensure you have selected the proper input source on your vehicle's stereo system.
No audio when using PowerConnect+ or FM/DA	<ul style="list-style-type: none"> • Check that your Radio and your vehicle's FM Radio are tuned to the same FM channel.
Audio sounds too soft	<ul style="list-style-type: none"> • Raise the volume of your stereo system or increase the audio level of your Radio until the volume improves. Refer to the User Guide which accompanied your Radio for instructions.

Troubleshooting

If this happens:	Try this:
Audio fades or has static when listening	<ul style="list-style-type: none">• Check all cables for a firm and secure connection.• If you are using <i>PowerConnect+</i> or the <i>FMDA</i> to listen via your vehicle's FM radio, and the problem persists, it most likely is interference from another commercial or broadcast FM station. You will need to find an unused or available FM channel in your area. Refer to "Option 3: <i>PowerConnect+</i> Installation Instructions" on page 42, step 3.• If you are using <i>PowerConnect+</i>, and you cannot solve the audio problem, try connecting the audio using the <i>Aux In Cable</i> or a <i>Cassette Adapter</i>. (Refer to page 38 and page 40.) If you cannot use those solutions, consider using an <i>FM Direct Adapter</i>. (Refer to page 44.)
No song title or artist name is displayed	<ul style="list-style-type: none">• The information may not be available or updates may be in progress.

Product Specifications

Product Specifications

System:

Power Requirements:	9-16 V DC, 500 mA (max)
Operating Temperature:	4°F to +140°F (-20°C to +60°C)
Audio Output:	1.8 Vrms (max) Radio Dependent

PowerConnect+ Vehicle Dock:

Dimensions:	4.0 in (width) x 2.3 in (height) x 1.2 in (depth) 102 mm (width) x 59 mm (height) x 31 mm (depth)
Weight:	1.6 oz (46 g)
Audio Connector:	1/8 in (3.5 mm) female
Antenna Connector:	SMB male
Power Connector:	Female

PowerConnect+ Power Adapter:

Dimensions:	3.7 in (width) x 1.7 in (height) x 1.3 in (depth) 94 mm (width) x 43 mm (height) x 34 mm (depth)
Weight:	2.4 oz (69 g)
Input/Output:	9-16 V DC / 5 V DC, 1.5 A
Cable Length:	4 ft 7 in (1.4 m)

Vehicle Antenna:

Type:	Sirius Magnetic Mount
Connector:	SMB female, right angle
Cable Length:	23 ft (7.0 m)

Aux In Cable:

Connectors:	1/8 in (3.5 mm) stereo male to 1/8 in (3.5 mm) stereo male
Cable Length:	4 ft (1.2 m)

Patent and Environmental Information

Patent Information

It is prohibited to, and you agree that you will not, copy, decompile, disassemble, reverse engineer, hack, manipulate, or otherwise access and/or make available any technology incorporated in this product. The music, talk, news, entertainment, data, and other content on the Services are protected by copyright and other intellectual property laws and all ownership rights remain with the respective content and data service providers. You are prohibited from any export of the content and/or data (or derivative thereof) except in compliance with applicable export laws, rules and regulations. The user of this or any other software contained in a SiriusXM Radio is explicitly prohibited from attempting to copy, decompile, reverse engineer, hack, manipulate or disassemble the object code, or in any other way convert the object code into human-readable form.

Environmental Information

Follow local guidelines for waste disposal when discarding packaging and electronic appliances.

Your Second Vehicle Kit is packaged with cardboard, polyethylene, etc., and does not contain any unnecessary materials.

IC Statement

This Class B digital apparatus complies with Canadian ICES-003.

IC STATEMENT

Operation is subject to the following two conditions: (1) this device may not cause interference, and (2) this device must accept any interference, including interference that may cause undesired operation of the device. For product available in the Canada market, only channel 1~11 can be operated. Selection of other channels is not possible. This device and its antenna(s) must not be co-located or operation in conjunction with any other antenna or transmitter. To reduce potential radio interference to other users, the antenna type and its gain should be so chosen that the equivalent isotropically radiated power (e.i.r.p) is not more than that permitted for successful communication. IC Radiation Exposure Statement: This equipment complies with IC RSS-102 radiation exposure limits set forth for an uncontrolled environment. This equipment should be installed and operated with minimum distance 20cm between the radiator & your body.

FCC Statement

The user is cautioned that changes or modifications not expressly approved by Sirius XM Canada Inc. can void the user's authority to operate this device.

This device complies with Part 15 of the FCC Rules. Operation is subject to the following two conditions:

1. This device may not cause harmful interference.
2. This device must accept any interference received, including interference that may cause undesired operation.

This equipment has been tested and found to comply with the limits for a Class B digital device, pursuant to Part 15 of the FCC Rules. These limits are designed to provide reasonable protection against harmful interference in a residential installation.

This equipment generates, uses, and can radiate radio frequency energy and, if not installed and used in accordance with the installation instructions, may cause harmful interference to radio communications. However, there is no guarantee that interference will not occur in a particular installation. If this equipment does cause harmful interference to radio or television reception, which can be determined by turning the equipment off and on, the user is encouraged to try to correct the interference by one or more of the following measures:

- Reorient or relocate the receiving antenna of the affected receiver.
- Increase the separation between the equipment and the affected receiver.
- Connect the equipment into an outlet on a circuit different from that to which the affected receiver is connected.
- Consult the dealer or an experienced radio/TV technician for help.

WARNING! The FCC and FAA have not certified Satellite Radio Receiver use in any aircraft (neither portable nor permanent installation). Therefore, Sirius XM Canada Inc. cannot support this type of application or installation.

Copyrights and Trademarks

© 2012 Sirius XM Canada Inc. "SiriusXM", the SiriusXM logo, channel names and logos are trademarks of Sirius XM Radio Inc. and are used under license. "NFL" and the NFL Shield design are trademarks of the National Football League. NASCAR® is a registered trademark of the National Association for Stock Car Auto Racing, Inc. The NBA and NBA member team identifications are the intellectual property of NBA Properties, Inc. and the respective NBA member teams. © 2012 NBA Properties, Inc. All rights reserved. NHL and the NHL Shield are registered trademarks of the National Hockey League. © NHL 2012. Elvis Radio logo © EPE Reg. U.S. Pat & TM off. CFL® is a registered trademark of the Canadian Football League. All other trademarks, service marks, images and logos are property of their respective owners and are used with permission. All Rights Reserved. Required subscription sold separately. Premier subscription required for some channels. Prices and programming is subject to change. See Customer Agreement for complete terms at siriusxm.ca.

www.siriusxm.ca

**Sirius XM Canada Inc.
135 Liberty St. - 4th floor
Toronto, Ontario, M6K 1A7**

1-888-539-SIRIUS (7474)

© 2012 Sirius XM Canada Inc.

Sirius Vehicle Kit User Guide 121004a