

STILETTO 10

Live Portable Satellite Radio



User Guide

Congratulations on the purchase of your new Stiletto 10!

The Stiletto 10™ is SIRIUS's first live personal satellite radio. It includes everything you need to listen live to SIRIUS® radio almost anywhere you want to go. Powerful features allow you to record up to 10 hours of SIRIUS broadcasts.

With your Stiletto 10 you can:

- Listen live to 110 SIRIUS satellite channels of 100% commercial free music, sports, and talk programming.
- Store up to 10 hours of recordings from live SIRIUS broadcasts.
- Schedule recordings up to 6 hours long so you never miss your favorite shows.
- Mark any music or artist you hear for a seek alert, which will alert you whenever that song or artist is playing.

The Stiletto 10 includes My Sirius Studio™ software to keep the device software current.



Table of Contents

TABLE OF CONTENTS.	2
WARNING AND SAFETY INFORMATION.	4
IC Caution	4
General Precautions	5
PACKAGE CONTENTS.	7
BATTERY LIFE, INSTALLATION, AND CHARGING.	10
CONTROLS	13
Stiletto 10 Reference Guide	13
Vehicle Dock Button and Connector Guide	16
Remote Control Reference Guide	18
Using the Media Dial	20
GETTING STARTED	21
Turning the Stiletto 10 On/Off, Sleep, and Lock Modes	21
Navigating Menus and Lists	22
Receiving the SIRIUS Satellite Signal	24
Subscribing to the SIRIUS Service	25
Connecting the Stiletto 10 to a PC Computer	26
OPERATION	27
Satellite Radio	28
Library	40
Radio Replays	46
Recording	50
Settings	54
VEHICLE DOCKING STATION INSTALLATION & USE	59
Installing the Vehicle Docking Station	59
Installing the Antenna	64
Connecting the Cigarette Lighter Adapter	66
Docking and Un-docking the Stiletto 10	67

Selecting an FM Frequency	68
Presets	69
Direct Channel Tuning	70
MY SIRIUS STUDIO SOFTWARE INSTALLATION	71
TROUBLESHOOTING	72
OPTIONAL ACCESSORIES.	74
SPECIFICATIONS.	76
WARRANTY	77
END USER LICENSE AGREEMENT	78
COPYRIGHTS & TRADEMARKS	86
Copyrighted Broadcast Material	86
Copyrights & Trademarks	86
SIRIUS ID	87
INDEX.	88

Warning and Safety Information

IC Caution

Operation is subject to the following two conditions: (1) this device may not cause interference, and (2) this device must accept any interference, including interference that may cause undesired operation of the device.

To reduce potential radio interference to other users, the antenna type and its gain should be so chosen that the equivalent isotropically radiated power (EIRP) is not more than that required for successful communication. This device has been designed to operate with an antenna having a maximum gain of 2 dBi. Antenna having a higher gain is strictly prohibited per regulations of Industry Canada. The required antenna impedance is 50 ohms.

To reduce potential radio interference to other users, the antenna type and its gain should be so chosen that the equivalent isotropically radiated power (e.i.r.p.) is not more than that permitted for successful communication.

IMPORTANT NOTE:

IC Radiation Exposure Statement

This EUT is compliance with SAR for general population/uncontrolled exposure limits in IC RSS-102 and had been tested in accordance with the measurement methods and procedures specified in IEEE 1528. This equipment should be installed and operated with minimum distance 1.5cm between the radiator & your body.

Body Worn Operation

To maintain compliance with IC RF exposure requirements, use only belt-clips, holsters or similar accessories that does not contain metallic components in its assembly. The use of accessories that do not satisfy these requirements may not comply with IC RF exposure requirements, and should be avoided.

This device and its antenna(s) must not be co-located or operating in conjunction with any other antenna or transmitter.

General Precautions

SIRIUS disclaims all liability for hearing loss, bodily injury, or property damage as a result of the use or misuse of this product.

Volume and Hearing Safety Precautions

- When listening to your Stiletto, be aware of your surroundings. The use of earbuds or headphones while riding a bike or operating a vehicle or motorcycle may be prohibited by law, and is not recommended.
- If you experience ringing in the ears while listening, stop using the Stiletto and consult a medical professional.
- When using your Stiletto, start the volume low and gradually turn it up to a medium level which you can hear. If the ambient sounds around you are noisy or loud, do not turn the volume up to high level. Find a quieter location instead.
- Permanent hearing loss can occur if you set the volume too high. Your ears adapt to the loud volume and can be permanently damaged.
- The use of earbuds or headphones for an extended period of time can cause serious damage to your ears. Wearing them for prolonged periods of time or while sleeping is not recommended.

Liquid Crystal Precautions

If the LCD screen on the Stiletto is damaged, do not to touch the liquid crystal fluid. If any of the following situations happen, take the action indicated:

1. If the liquid crystal fluid comes in contact with your skin, wipe the skin area with a cloth and then wash the skin thoroughly with soap and running water.
2. If the liquid crystal fluid gets into your eye, flush the eye with clean water for at least 15 minutes. Seek medical care.
3. If the liquid crystal fluid is ingested, flush your mouth thoroughly with water. Drink large quantities of water and induce vomiting. Seek medical care.

General Safety Precautions

Be sure to observe the following warnings. Failure to follow these safety instructions and warnings may result in a serious accident.

- Do not expose the Stiletto to moisture or use it near or in water. Do not handle it with wet hands, or let water or any other liquid spill on or in it.
- Do not operate the Stiletto in a way that might divert your attention from driving safely. As a driver, you alone are responsible for safely operating your vehicle in accordance with traffic safety laws at all times.
- Be sure the unit is installed as described in the installation instructions in this guide. When installing the unit using a Vehicle Kit, Home Kit or Executive Sound System, follow the installation instructions included with those accessories.
- To avoid short circuits, do not open the unit, and never put or leave any metallic objects (coins, tools, etc.) inside the unit.
- If the unit emits smoke or unusual odors, turn the power off immediately, and disconnect the unit from any power source.
- Do not drop the unit or subject it to strong shocks.
- If the unit doesn't seem to be working properly, turn the unit off, remove the battery from the unit, wait 10 seconds, replace the battery and then turn it on again.

My Sirius Studio Software

The My Sirius Studio software CD-ROM included with the Stiletto 10 will allow you to connect your Stiletto 10 to your PC computer running the Windows® XP operating system with Service Pack 2. Be sure to periodically connect the Stiletto 10 to your PC computer to load the latest device software updates. Refer to the user guide included on the software CD-ROM for further information on installing and using the software.

The My Sirius Studio software should be installed *before* connecting the Stiletto 10 to your PC computer.

Operating Temperature

The Stiletto 10 is designed to operate between -5° to +40° C (23° to 104° F). Avoid leaving the unit in a vehicle or elsewhere where the temperature may fall outside this range. Extreme temperatures or extreme temperature fluctuations can degrade the performance of the LCD display screen, and possibly damage it.

Cleaning and Maintenance

If the Stiletto 10 becomes dirty, turn the power off and wipe it clean with a soft clean cloth. Do not use hard cloths, paint thinner, alcohol, or other volatile solvents to clean. These may cause damage to the unit.

Package Contents

The following items are included with your purchase of the Stiletto 10:



Stiletto 10

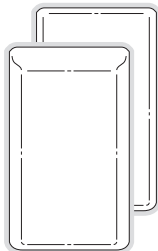

**Two Batteries
(Standard & Slim)**



Remote Control



**Vehicle Docking
Station**

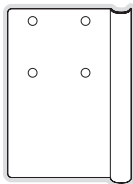

**Docking Station
Finger Grip**

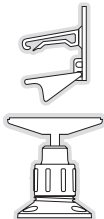

Vehicle Mounts



Ear Buds & Pads

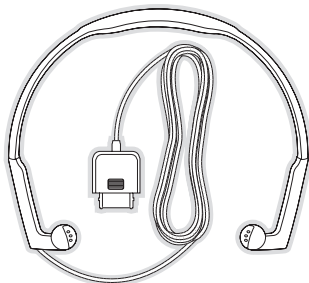

Antenna Headphones



USB Cable

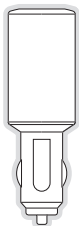

Cigarette Lighter Adapter

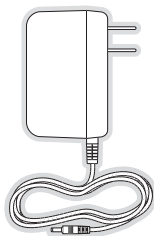

AC Adapter



Magnetic Antenna



Antenna Cable Cover/Tail



Mounting Screws



Alcohol Swab



User Guide, Quick Start Guide, Inserts, and PC Software CD

ENHANCING THE VERSATILITY OF YOUR STILETTO

Stiletto Vehicle Kit (Model SLV1C)

In order to use your Stiletto in a vehicle, you will need the Stiletto Vehicle Kit. The kit includes a compact vehicle dock that rapidly charges your Stiletto's battery, connects to an externally mounted antenna for more reliable reception, and plays audio through your vehicle's stereo system. Ten dedicated preset buttons (30 presets total) and an included remote control make it easy to tune and operate your Stiletto without taking your eyes from the road.

Stiletto Home Kit (Model SLH1C)

The Stiletto Home Kit provides everything you need to use the Stiletto in your home or office. The sleek home dock provides a convenient way to charge your Stiletto's battery along with an extra slot for charging a spare battery. The included indoor/outdoor antenna provides improved reception, while audio cables enable you to connect the Stiletto to amplified speakers or a home entertainment system. A remote control is included, along with USB cable and PC computer software for optionally connecting the home dock to your PC computer.

Battery Life, Installation, and Charging

Two batteries are supplied with your Stiletto 10, a slim battery and a standard battery. The batteries when fully charged will provide a range of listening times depending on the listening mode. The following table provides the approximate listening times:

Listening Mode	Approximate Listening Time	
	Standard Battery	Slim Battery
Satellite Radio	4 hours	2 hours
Library	20 hours	10 hours
Radio Replays	20 hours	10 hours

As batteries age, the amount of listening time diminishes. Replacement (or spare) batteries are available from your SIRIUS product distributor.

The amount of listening time the battery provides is dependent upon several settings: decreasing the length of time the backlight of the display screen remains on will prolong battery life as well as adjusting the brightness of the display screen to a dimmer setting. Both of these adjustments are made through the *Settings* menu. Refer to **Brightness** and **Backlight Timer** on page 55 for details about these settings.

Stiletto 10 Battery Installation and Removal

To install the battery, refer to Figure 1 and slide the bottom of the battery (1) into the bottom of Stiletto 10 (2) until the battery engages the clips. Then press the left side of the battery down (3) until the release latch (4) locks the battery in place.

To remove the battery from the Stiletto 10, pull the release latch (4). When the battery pops up, grasp the battery and slide it toward the latch until it disengages from the radio.

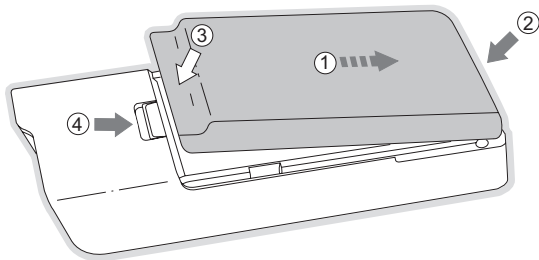

Figure 1

Battery Charging

The battery in the Stiletto 10 is shipped partially charged but should be fully charged before using. For the fastest charging time, the Stiletto 10 should be turned off while the battery is being charged. When off, a fully discharged slim battery will charge in 2 hours and a standard battery will charge in 4 hours.

To charge the Stiletto, power the unit off and connect the AC Adapter as shown in Figure 2.



Figure 2

Battery Disposal

When disposing of batteries, do so in accordance with the local waste disposal regulations. Batteries should not be disposed of in household waste, but should be recycled instead.

Controls

Stiletto 10 Reference Guide

Figure 1 identifies the buttons, controls, and connectors of the Stiletto 10.

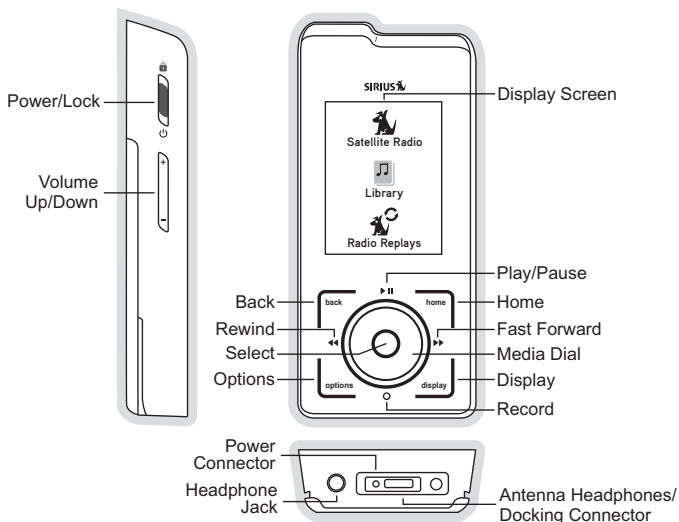













Figure 1

The following table describes the functions of the buttons and controls on the Stiletto 10.

Stiletto 10 Button and Control Descriptions			
Button	Action	Satellite Radio Mode	Replay/Library Mode
 Power/Lock	Slide Up	Locks all buttons on the Stiletto 10	
	Center	Unlocks all buttons on the Stiletto 10	
	Slide Down	Slide down and release: Turns Stiletto 10 On (if Off), or places radio in sleep mode (if On) Slide down and hold for 5 seconds: Turns the Stiletto 10 Off	
 Volume	Press	+ Increases the audio volume - Decreases the audio volume	
 Play/Pause	Press	Pauses a broadcast or resumes playing a paused broadcast	Pauses or resumes playing the recording
 Rewind	Press	If listening, skips to the previous song or show If in a channel or preset list, moves through categories or preset banks	Skips to the beginning of the song or show
	Hold	If listening, rewinds through a broadcast	Rewinds through song or show
 Fast-Forward	Press	If listening, skips in the replay buffer to the next song or show If in a channel or preset list, moves through categories or preset banks	Skips to the next song or show
	Hold	Fast-Forwards through the replay buffer	Fast-Forwards through song or show

Stiletto 10 Button and Control Descriptions *Continued*

Button	Action	Satellite Radio Mode	Replay/Library Mode
 Record	Press	Displays recording setup screen.	No Action
	Hold	While recording, prompts to stop recording	No Action
 Media Dial	Scroll	If listening, displays channel or category list If in a list, menu, or prompt, scrolls to next or previous item	
 Select	Press	Selects highlighted item a in list, menu, or prompt	
 back	Press	Returns back to the screen displayed just prior to the currently displayed screen	
 home	Press	First press returns to the Home screen Additional press returns to the Now Playing screen	
 options	Press	Displays available options for the currently displayed screen If no options are available, nothing is displayed	
 display	Press	Cycles between 3-channel display mode, 6-channel display mode, artist name, and song title when in the channel browsing mode	Cycles list of recordings between order by date or by channel (Library mode only)

Vehicle Dock Button and Connector Guide

Figure 2 identifies the buttons and connectors of the Vehicle Dock.

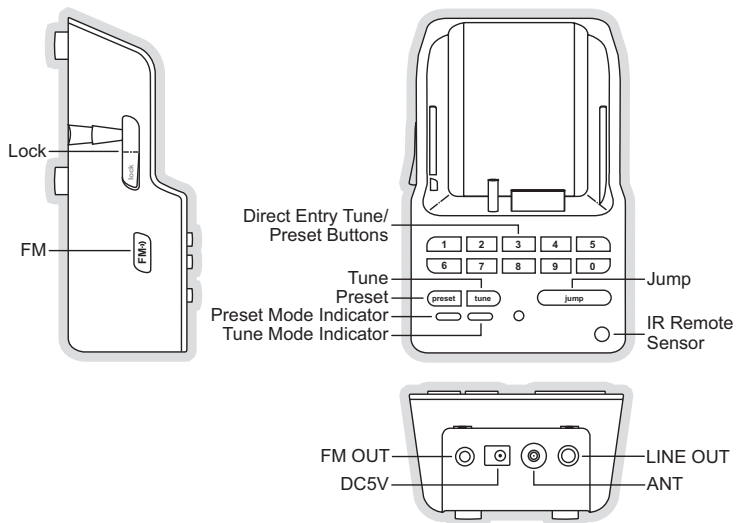

Figure 2

The following table identifies the buttons and connectors of the Vehicle Dock.

Vehicle Dock Button and Connector Descriptions		
Button/ Connector	Action	Description
0 – 9	Press	<i>In Tune Mode:</i> Directly selects the channel indicated by the numbers which were pressed <i>In Preset Mode:</i> Selects presets 0 – 9
tune	Press	Changes to the direct tuning mode where channel numbers may be entered
preset	Press	Changes to the preset mode and displays the list of preset channels A second and subsequent press cycles through the preset banks, A, B, and C
jump	Press	Jumps to a preselected traffic/weather channel, or other preselected channel A second press returns to the previous channel or song/show
FM	Press	Displays the FM Frequency screen where the FM transmitter frequency can be selected, or a FM preset selected using the 0 – 9 buttons
Lock	Toggle	Locks or unlocks the Stiletto 10 in the vehicle dock
FM OUT	This connection is used for the optional FM Relay Switch which connects to the vehicle's FM radio antenna input	
DC 5V	Connection for the Cigarette Lighter Adapter	
LINE OUT	Audio output for connection to the vehicle's audio system. An audio cable (not supplied) is required to utilize this connection	
ANT	Connection for the Magnetic Antenna	

Remote Control Reference Guide

Figure 3 identifies the buttons of the remote control. The remote control works only when the Stiletto 10 is in the vehicle or home dock.

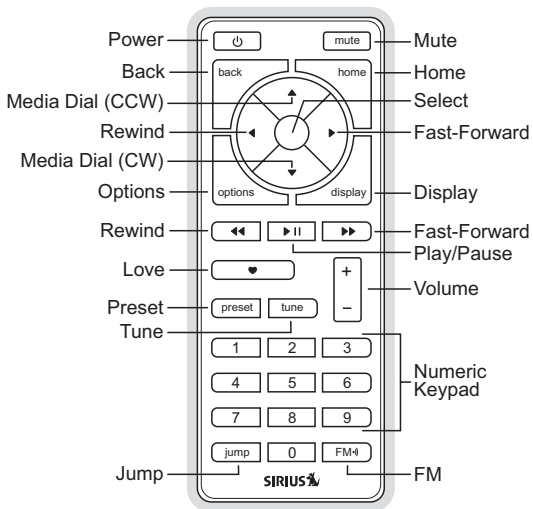





Figure 3

The following table describes the functions of the buttons unique to the remote control. Please refer to the Stiletto 10 or vehicle dock button descriptions for the descriptions of the other buttons.

Remote Control Button Descriptions		
Button	Action	Description
 Power	Press	Turns the Stiletto 10 On/Off
0 - 9	Press	<i>In Tune Mode:</i> Directly selects the channel indicated by the numbers which were pressed <i>In Preset Mode:</i> Selects presets 0 – 9
Mute	Press	Mutes (or un-mutes) the audio
 Up/Down	Press	Pressing Up is equivalent to turning the Media Dial counter-clockwise Pressing Down is equivalent to turning the Media Dial clockwise
 Left/Right	Press	Pressing Right is equivalent to Fast-Forward Pressing Left is equivalent to Rewind

Using the Media Dial

The ● Media Dial of the Stiletto 10 is controlled by placing your finger on the ● Media Dial and rotating the dial clockwise or counter-clockwise to scroll, highlighting a channel, genre, preset, menu item, or list item. (Figure 4) It may also be pressed at the north, south, east and west locations for selecting ►► Play/Pause, ○ Record, ►► Fast-Forward, and ◀◀ Rewind as labeled. Pressing the center button provides the ● Select function for selecting a highlighted item.

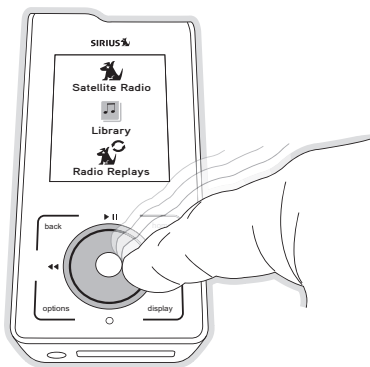





Figure 4

Getting Started

Turning the Stiletto 10 On/Off, Sleep, and Lock Modes

To turn the Stiletto 10 on, slide the  Power/Lock switch down momentarily and then release it. When on, to put the Stiletto into sleep mode, slide the  Power/Lock switch down momentarily and release it. The Stiletto will display *Going to Sleep*. (Figure 1) Sleep mode allows the Stiletto to start up quickly when powered on. The Stiletto will power itself completely off after 18 hours of sleep.

To turn the Stiletto 10 completely off, hold the  Power/Lock switch down for 5 seconds until the display goes blank. When completely off, the battery will remain charged for several weeks. When completely off, the Stiletto will take 1–2 minutes to power up. (Figure 2)



The Stiletto 10 may be locked to prevent the accidental pressing of a button by sliding the  Power/Lock switch up to the locked position (Figure 3) The  Power/Lock switch must be placed back into the unlocked (center) position for the other buttons to function.



Figure 1



Figure 2

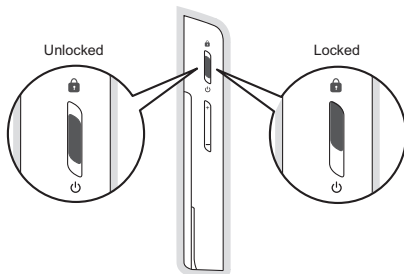

Figure 3

Navigating Menus and Lists

The menu and list structures in the Stiletto 10 are navigated by using the **Media Dial** to scroll through a menu or list to highlight your choice, and then pressing the **Select** button to select the choice. To return to the Home screen at any time, press the **Home** button. (Figure 4)

Tip: Pressing the **Home** button twice from any menu will return you to the Now Playing screen.



Figure 4

Let's say you have saved a recording from channel 13 and now you want to listen to it. Use the **Media Dial** to highlight a choice and press the **Select** button to select the choice until you have navigated to the song. Refer to Figure 5 for an example.

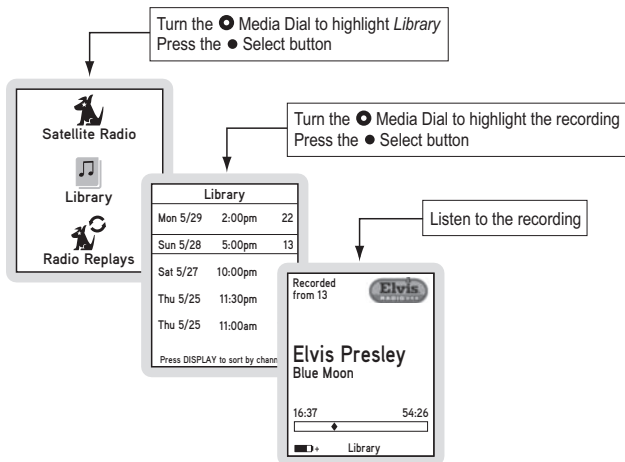

Figure 5

In this user guide, menu or list structures like the previous example are shown as:

Home → *Library* → *[Select from list]* → Listen.

The **Back** button will move you back to the previous display screen and the **Home** button will return you to the Home screen. Pressing the **Home** button again will return you to the Now Playing screen.

Receiving the SIRIUS Satellite Signal

The SIRIUS satellite signal is broadcast from satellites covering almost all of North America. To receive the satellite signal your Stiletto must have a clear view of the sky. Obstructions such as buildings, trees, bridges and high voltage power lines can easily interfere with the satellite signal. For that reason SIRIUS also broadcasts its signal from terrestrial radio towers in most major cities.

To activate or use your Stiletto 10 in portable mode, first be sure you have a strong satellite or terrestrial signal. You may view the signal strength in your location by navigating to *Settings* → *Device* → *Antenna Aiming*. (Figure 6) At least one of the signals should be greater than 50% to reliably activate and use the Stiletto 10.

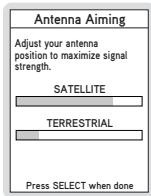



Figure 6

Signal reception can be greatly improved by installing the Stiletto 10 in the vehicle dock, or by attaching the antenna headset (included). For best performance it is recommended that you use your Stiletto 10 with one of these accessories when activating your subscription.

Figures 8 and 9 illustrate several unacceptable situations where obstacles are blocking the Stiletto 10 from having a clear view of the sky, preventing reception of the signal from the SIRIUS satellites.

Subscribing to the SIRIUS Service

Before you can listen to the SIRIUS service, you need to activate your subscription. To subscribe, do the following:

1. Be sure that the Stiletto 10 is correctly installed, is in the vehicle dock, and that the antenna is oriented to receive the SIRIUS signal.
2. Turn on the Stiletto 10. After the startup sequence, Select *Satellite Radio* → *All Channels* and tune to channel 184. The SIRIUS channel line-up will begin updating. Wait until the channel updates have completed before pressing any buttons.
3. Once the channels have been updated, the display will change to *Call 1-888-539-SIRIUS to Subscribe*. You will not be able to listen to other channels until you activate your SIRIUS subscription.
4. Use the ● Media Dial to tune to channel 0 to display the Stiletto 10's unique 12-digit SIRIUS ID Number (SID). (Figure 7) You can also tune to channel 0 by using the remote control: Press the  Tune button, then the 0 (zero) button and then the ● Select button. The SID number is also available on the Stiletto 10's packaging, and may also be accessed by selecting *Settings* → *Device* → *Sirius ID*. Write the SID number down in the space provided near the end of this guide.
5. Have your credit card handy and contact SIRIUS on the Internet at: <https://www.siriuscanada.ca/activate/> and follow the prompts to activate your subscription. You can also call SIRIUS toll-free at: 1-888-539-SIRIUS (1-888-539-7474).
6. When you have successfully subscribed to the SIRIUS service, and the Stiletto 10 has been updated with your subscription information, an alert will be displayed. To continue, press the ● Select button.

You are now ready to begin enjoying SIRIUS Satellite Radio's digital entertainment, and can tune to other channels!

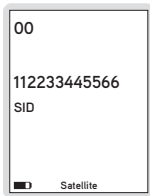

Figure 7

Connecting the Stiletto 10 to a PC Computer

Your Stiletto 10 includes My Sirius Studio software and a USB cable for connecting to a PC computer. The Stiletto 10 should be periodically connected to a PC computer to receive device software updates for the Stiletto.

Before connecting the Stiletto 10 to your PC computer, install the My Sirius Studio software that came with your Stiletto. Refer to the **My Sirius Studio Software Installation** section on page 71 for more information.

To connect the Stiletto 10 to a PC computer, connect one end of the USB cable to the Stiletto 10 and the other end to an available USB port on the PC computer, as shown in Figure 8.

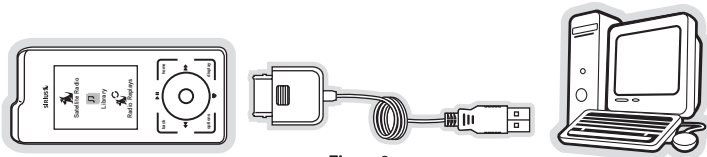

Figure 8

Your PC computer software will recognize the Stiletto and ask you which application you want to use to manage the content on your device. Choose My Sirius Studio.

When you connect to the PC computer, the Stiletto will display a message asking you to turn off Satellite Radio and connect. (Figure 9) You may cancel and continue listening to satellite radio, or stop satellite radio and connect to the PC computer.

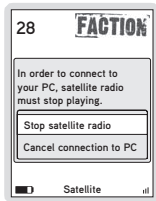

Figure 9

Operation

The Stiletto 10 delivers great audio entertainment in three distinct listening environments:

- **Satellite Radio.** Listen live to satellite broadcasts of all SIRIUS 100% commercial free music channels, talk, and sports programming. (Page 28)
- **Library.** Listen to recordings saved from SIRIUS broadcasts. (Page 40)
- **Radio Replays.** Listen to content which has been automatically saved from your favourite music channels. (Page 46)

Each of these environments are described in detail in the sections following along with:

- **Recording.** Set up scheduled recordings to record SIRIUS broadcasts. (Page 50)
- **Settings.** Make changes to the global settings of the Stiletto 10 to personalize your experience. (Page 54)



Satellite Radio

Satellite Radio allows you to listen to live SIRIUS broadcasts when you are receiving a signal from the SIRIUS satellite or terrestrial transmitters. You can browse and select the SIRIUS channels, and see information about the songs, artists, sports, news, weather, and traffic being broadcast.

To access Satellite Radio on your Stiletto 10, from the Home screen use the ● Media Dial to highlight Satellite Radio and press the ● Select button.

NOW PLAYING SCREEN INFORMATION

The Now Playing screen for Satellite Radio provides information such as the currently tuned channel, song or show being played, mode, recording, and other information. Figure 1 identifies the information which may be displayed when in the Satellite Radio mode.

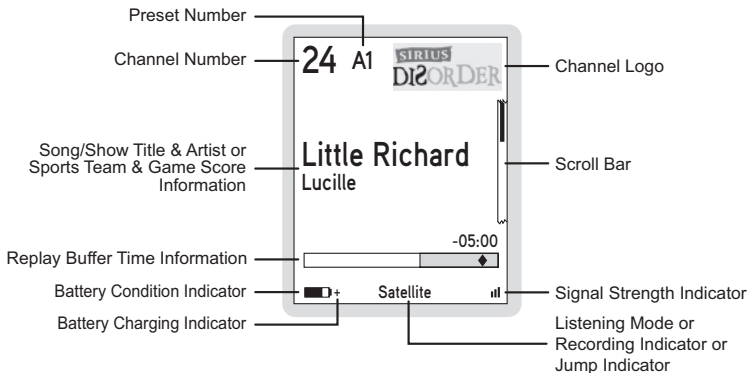

Figure 1

BROWSING AND NAVIGATING CHANNELS

When Satellite Radio is selected (Figure 2), channels may be browsed in several ways:

- In a list of all channels in numerical order. (Figure 3)
- In a list of channels which have been saved as presets. (Figure 4)
- In groupings of channels by genre (also referred to as categories) such as *Pop*, *Rock*, *Country*, etc. (Figure 5)

Use the **Media Dial** to highlight your choice, and press the **Select** button.

As you browse the lists, the channel names will be spoken if this feature is enabled. Channels may be selected for listening from any of the lists by using the **Media Dial** to scroll and highlight a selection and then pressing the **Select** button.

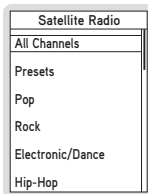

Figure 2



Figure 3

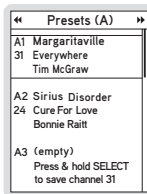

Figure 4



Figure 5

The **Display** button toggles the display screen between a 3 channel list mode and a 6 channel list mode. (Figures 6 & 7)

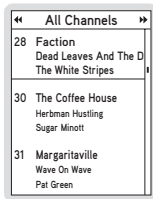

Figure 6



Figure 7

CHANNEL PRESETS



Channels which you tune frequently and want to be able to access quickly may be added to a list of presets. Presets are grouped into three banks, A, B, and C which store 10 presets each for a total of 30 presets. Presets are displayed as A1, A2, B1, B2, etc. (Figure 4)

Tuning to a Saved Preset

Saved presets may be selected by browsing the Presets category:







1. Select *Presets* from the *Satellite Radio* screen. (Figure 2)
2. Use ◀◀ Rewind and ▶▶ Fast Forward to navigate between the A, B, and C banks of presets. (Figure 4)
3. Use the ● Media Dial to highlight a preset and press the ● Select button.

When the Stiletto 10 is in the vehicle dock, presets may be selected by pushing the 0–9 buttons on the vehicle dock when the dock is in the preset mode. To tune to a saved preset:

1. Press the  Preset button on the vehicle dock. The preset mode indicator light will indicate that the preset mode is active.
2. Select the desired preset band (A, B, or C) by repeatedly pressing the  Preset button until the desired preset band is displayed. (Figure 12)
3. Press one of the 0–9 buttons to select the desired preset.

Saving Channels as Presets

To save a channel as a preset:

1. Tune to the desired channel.
2. Press the  Options button.
3. Highlight *Save Channel as Preset* and press the  Select button. (Figure 8)
4. The *Presets* screen will be displayed. Use  Rewind and  Fast Forward to navigate between the A, B, and C banks of presets, and use the  Media Dial to highlight the preset where you want the channel saved. Press and hold the  Select button to save the channel as a preset.

If you have chosen a preset which has already been assigned to a channel, the preset will be replaced with the new channel.

Removing a Channel Preset

To remove a channel as a preset:





1. Select *Presets* from the *Satellite Radio* screen. (Figure 2)
2. Use  Rewind and  Fast Forward to navigate between the A, B, and C, banks of presets. (Figure 4)
3. Use the  Media Dial to highlight the preset you want to remove and press the  Options button.
4. Highlight *Remove this Preset* and press the  Select button to remove the preset. (Figure 9)



Figure 8

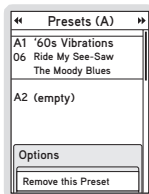

Figure 9

PAUSING, REWINDING, AND REPLAYING LIVE RADIO

While listening to satellite radio, up to the most recent 60 minutes of the broadcast may be put into a temporary replay buffer. You may rewind to replay something you just heard or you may press **||** Play/Pause to pause the live broadcast. You may resume listening to the broadcast at any time, beginning from the point where the broadcast was paused, or you can fast-forward or rewind through the replay buffer, pause the replay buffer again, or return to the live broadcast.

The replay buffer is retained until the memory becomes full. When memory becomes full, the oldest part of the replay buffer is deleted to make room for the new material so that the live broadcast can continue to be added to the replay buffer. The replay buffer is discarded when the Stiletto 10 is either turned off or tuned to another channel or to a playlist.

Pausing a Live Broadcast

To pause a live broadcast:

1. Press **||** Play/Pause to pause a live broadcast.
2. The audio will mute and a time bar will be shown near the bottom of the display screen indicating how much of the replay buffer is filled with the broadcast. (Figure 10)

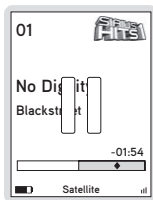

Figure 10

Playing a Paused Broadcast

Press **||** Play/Pause to begin playing a paused broadcast from the point at which it was paused. To jump ahead to the live broadcast, press **▶▶** Fast-Forward until you reach the live broadcast.

Fast-Forwarding and Rewinding Through Broadcasts

Press **▶▶** Fast-Forward or **◀◀** Rewind to navigate through the replay buffer. Pressing and releasing moves forwards or backwards to the start of the next or previous segment.

Pressing and holding **▶▶** Fast-Forward or **◀◀** Rewind moves progressively faster forward or backwards in the buffer.

As you fast-forward or rewind, the **◆** diamond indicator in the time bar will move to show your current playback position relative to the live broadcast. (Figures 11 & 12)



Figure 11

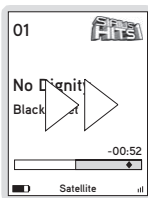

Figure 12

RECORDING FROM A LIVE BROADCAST

Content can be saved by using **○** Record when listening to a live satellite broadcast. If there is not enough space to save the content, the oldest content is deleted in order to make room for the new content. Recording sessions are limited to a maximum duration of 6 hours.

To record:

1. Press **○** Record to begin the recording. You will be prompted to select to record to the next hour (for example, *Record until 7:00 PM*), or to select *Recording options...* where you can customize the recording. (Figure 13) If you select to record to the next hour, recording will begin immediately.
2. If you have chosen *Recording options...*, you will be presented with a screen where you can change the parameters for the recording. (Figure 14)
3. Use the **●** Media Dial to highlight the parameter you want to change and press the **●** Select button.

- Use the **Media Dial** to scroll and change the parameter. When your selection is complete, press the **Select** button.
- When all the parameters have been set, use the **Media Dial** to highlight *Done* and press the **Select** button. The recording will then begin if you have set the parameters to begin immediately. The **Heart** icon will be displayed at the bottom center of the screen to indicate that a recording is in progress. (If you have selected for the recording to begin at a later time, the recording will begin at the scheduled time. Refer to the **Recording** section on page 50 for more information.)
- The recording is saved in the Library. Refer to the **Library** section on page 40 for information on playing back the recording.

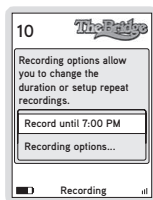

Figure 13

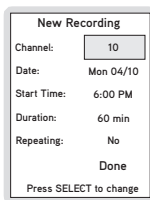

Figure 14

OTHER FEATURES

Game Alert

You can program the Stiletto 10 to remember your favourite sports teams. The Stiletto 10 will then automatically alert you when any of your favourite sports teams are playing in a game. There is no limit on the number of teams you can select for game alerts.

Adding and Removing Favourite Teams for Game Alerts

To add or remove favourite teams for game alerts:



1. From the Home screen select *Settings* → *Sports* → *Favourite Teams* and select the sports league or college for the team you want to add or remove. (Figure 15) →
→ To add teams for game alerts, select an individual team. (Figure 16)
Selected teams will appear in the list with a ✓ check mark in the box next to the team name.
Tip: To add all teams in the list, press the  Options button and choose *Select All*.
→ To remove teams, select the team you want to remove. The ✓ check mark next to the team name will be removed indicating it is no longer selected for game alerts.
2. You may continue selecting or removing teams from other sports leagues by using the  Back button to navigate back in the menu structure to select another league or college.



Figure 15

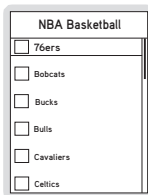



Figure 16

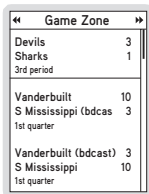

Figure 17

Whenever you're listening to Satellite Radio, either live or from the replay buffer, you'll receive an alert if any of your favourite teams are playing. (Figure 17) If you wish to tune to the channel playing the game, press the  Options button and select the *Listen to...* option.

Game Zone

The Game Zone category lists all the sports games which are currently playing for your favourite teams, and can be browsed for the games scores. (Figure 18) You can scroll through the list and select a game to tune to the channel where the game is being broadcast.



Game Zone	
Devils	3
Sharks	1
3rd period	
Vanderbilt	10
S Mississippi (bdcas)	3
1st quarter	
Vanderbilt (bdcas)	3
S Mississippi	10
1st quarter	

Figure 18

Sports Ticker

While you are listening to the Stiletto 10, you can have a sports ticker displayed which will show the scores of all your favourite teams which are currently playing. (Figure 19) The sports ticker is enabled through the *Settings* menu, as described in **Sports Ticker** on page 58.



19	
Dio	
Rainbow In The Dark	
Ohio St	0 1Q
Florida St (bdcas)	0

Figure 19

Parental Controls

The parental controls feature sets a password for access to specific channels. This will prevent access to these locked channels until the password is entered. (Figure 20)

No details about the current content of a locked channel will be displayed. When you attempt to access a locked channel, you will be prompted to enter your password before you can proceed. (Figure 21) The parental control feature is accessed through the *Settings* menu, as described in **Parental Controls** on page 58.

Hiding channels and genres, as described in the next section, can be an alternative to locking channels.

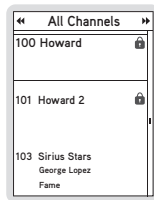

Figure 20

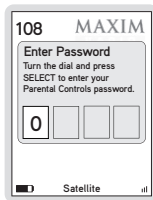

Figure 21

Hide Channels and Genres

The hide feature allows you to designate channels and genres to not be displayed when browsing channel and genre lists. The hide feature differs from the parental control lock feature in that a locked channel will be displayed while browsing a list (but is password protected), while a hidden channel will never appear in a list.

Hidden channels are not locked, but can only be tuned by directly entering the channel number using the numeric keypad on the remote control when the Stiletto 10 is in a docking station. The hide feature is accessed through the *Settings* menu, as described in **Channels** on page 55.

Artist and Song Seek Alert

This feature allows you to capture artist and song information in a seek list. When on, the radio continuously searches all SIRIUS channels and alerts you when an artist or song in the seek lists match a selection currently being played on another channel.

When a match is found to any artist or song in your seek lists, an alert will be displayed. (Figure 22) Pressing the  Options button when the alert is displayed will give you the choice to tune to the channel where the match was found, or to delete the artist or song from the seek list. (Figure 23)

Tip: Pressing the  Select button while the alert is displayed will immediately tune you to the channel on which the song/artist is playing.

To save an artist or song, press the  Options button when tuned to a channel, and select *Add Artist Seek* or *Add Song Seek*. (Figure 24)

The artist and song seek lists are maintained using the *Settings* menu, as described in *Artist and Song Seek* on page 54.



Figure 22

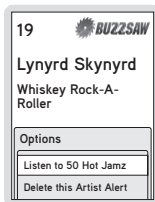

Figure 23

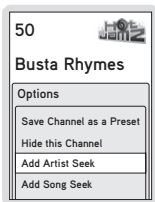

Figure 24



Library

The Library contains all the recordings you have saved from live broadcasts. All the music, sports, talk shows, news broadcasts, and talk entertainment recordings can be browsed and selected for playback from the Library.

To access the Library on your Stiletto 10, from the Home screen use the ● Media Dial to highlight Library and press the ● Select button.

NOW PLAYING SCREEN INFORMATION

When playing back content from the Library, the Now Playing screen provides information such as the song or show title, content length, and playback position. Figure 25 identifies the information which is displayed when in the Library mode.

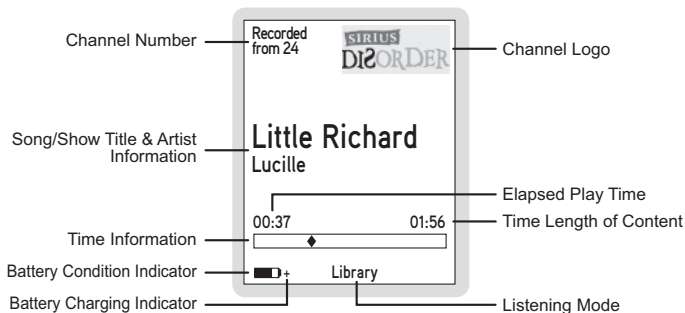





Figure 25

BROWSING AND NAVIGATING THE LIBRARY

The recordings in the Library may be browsed by date recorded or channel recorded. (Figures 26 & 27) Pressing the  Display button will allow you to select how the recordings will be sorted, either by date or by channel. Use the  Media Dial to scroll through the list and press the  Select button to select a highlighted item and begin playback.

While you are listening, the  Options button will allow you to delete the recording, or add the artist or song to the seek lists.

Library		
Mon 5/29	2:00pm	22
Sun 5/28	5:00pm	13
Sat 5/27	10:00pm	33
Thu 5/25	11:30pm	80
Thu 5/25	11:00am	22

Press DISPLAY to sort by channel

Figure 26

Library		
Sun 5/28	5:00pm	13
Thu 5/25	11:00am	22
Mon 5/29	2:00pm	22
Sat 5/27	10:00pm	33
Thu 5/25	11:30pm	80

Press DISPLAY to sort by date

Figure 27

NAVIGATING PLAYBACK

While listening to content in the library, you can pause, fast-forward, or rewind. Pressing **⏸** Play/Pause will pause the content, or begin playing again after a pause. Use **⏩** Fast-Forward and **⏮** Rewind to move through the content: a single press will skip to the end or the beginning of the content, while pressing and holding will move through the content.

A time bar is displayed in which a **◆** diamond icon indicates your current listening position in the content. (Figure 28)



Figure 28

DELETING CONTENT FROM THE LIBRARY

Pressing the **⌵** Options button while listening will allow you to delete the recording. (Figure 29)





Figure 29

Artist and Song Seek Alert

This feature allows you to capture artist and song information in a seek list. When on, the radio continuously searches all SIRIUS channels and alerts you when an artist or song in the seek lists match a selection currently being played on another channel.

When a match is found to any artist or song in your seek lists, an alert will be displayed. (Figure 30) Pressing the  Options button when the alert is displayed will give you the choice to tune to the channel where the match was found, or to delete the artist or song from the seek list. (Figure 31)

Tip: Pressing the  Select button while the alert is displayed will immediately tune you to the channel on which the song/artist is playing.

To save an artist or song, press the  Options button when tuned to a channel, and select *Add Artist Seek* or *Add Song Seek*. (Figure 32)

The artist and song seek lists are maintained using the *Settings* menu, as described in *Artist and Song Seek* on page 54.



Figure 30

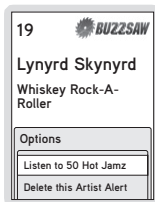

Figure 31

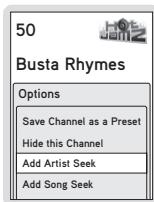

Figure 32

Storage Limits

The Stiletto 10 limits and automatically manages the allocation of memory for specific types of content. The following table shows how memory space is prioritized:

Content Type	Storage Limitation	Notes
Recordings & Scheduled Recordings	10 hours	Scheduled recordings will be kept to the minimum “keep” count with newer recordings replacing older content. (Refer to the Recording section on page 50 for more information.)
Radio Replays	Available Memory	Radio Replays are automatic recordings of favourite SIRIUS channels. (Refer to the Radio Replays section on page 46.) Radio Replays occupy any unused memory and are deleted automatically to make space available for other content.



Radio Replays

Radio Replays are automatic recordings of your favourite SIRIUS music channels. While listening to any SIRIUS music channel, blocks of programming may be saved for you in unused memory as a virtual channel. This assures that you will always have SIRIUS music to listen to, even when a Satellite Radio signal is not available.

Radio Replays are continuously refreshed. Once you have listened to the radio replay content, it may be deleted to make room for new content.

To access Radio Replays, from the Home screen use the **Media Dial** to highlight Radio Replays and press the **Select** button.

NOW PLAYING SCREEN INFORMATION

The Now Playing screen for Radio Replays provides information such as the channel the content was recorded from, song or show being played, mode, song length, and other information. Figure 33 identifies the information which is displayed when in the Radio Replays mode.

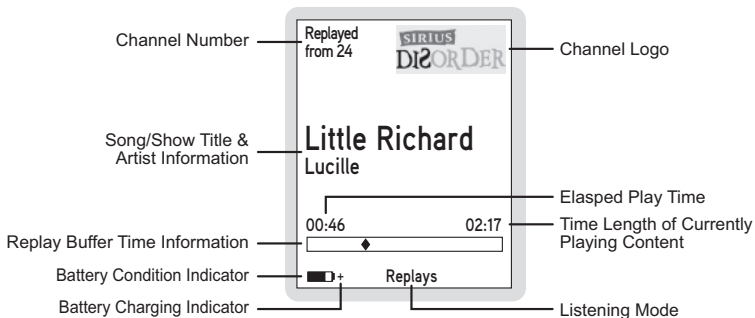
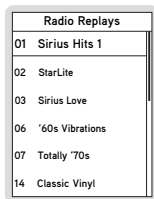

Figure 33

NAVIGATING RADIO REPLAYS

Radio Replays are listed in numerical order by SIRIUS channel (Figure 34). Use the **Media Dial** to scroll through the list of channels and the press the **Select** button to choose a Radio Replay.



Radio Replays	
01	Sirius Hits 1
02	StarLife
03	Sirius Love
06	'60s Vibrations
07	Totally '70s
14	Classic Vinyl

Figure 34

Play/Pause will pause and resume playback of the selected Radio Replay. **Fast-Forward** and **Rewind** allow you to move forward and backward through the content. The Stiletto 10 remembers the last point you paused or stopped in the Radio Replay and resumes playback at that point when you begin listening again.

The **Options** button allows you to delete all auto-recordings from a channel.

Artist and Song Seek Alert

This feature allows you to capture artist and song information in a seek list. When on, the radio continuously searches all SIRIUS channels and alerts you when an artist or song in the seek lists match a selection currently being played on another channel.

When a match is found to any artist or song in your seek lists, an alert will be displayed. (Figure 35) Pressing the  Options button when the alert is displayed will give you the choice to tune to the channel where the match was found, or to delete the artist or song from the seek list. (Figure 36)

Tip: Pressing the  Select button while the alert is displayed will immediately tune you to the channel on which the song/artist is playing.

To save an artist or song, press the  Options button when tuned to a channel, and select *Add Artist Seek* or *Add Song Seek*. (Figure 37)

The artist and song seek lists are maintained using the *Settings* menu, as described in *Artist and Song Seek* on page 54.



Figure 35

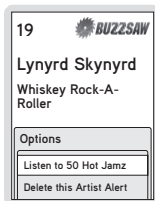

Figure 36

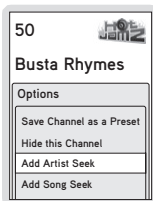

Figure 37



Recording

Recording allows you to schedule the Stiletto 10 to record programming at a set date and time. Each recording session may be up to 6 hours in length, and may be set up as a one time or repeating event. In order for a scheduled recording to occur, the Stiletto 10 must have adequate power and be able to receive the SIRIUS signal from the satellites or terrestrial transmitters. If the Stiletto is on or in sleep mode, the Stiletto will automatically tune to the correct channel and begin recording. If no signal is present at the time the recording is scheduled to start, the recording will be skipped.

Completed scheduled recordings can be found in the Library. To access to your scheduled recordings, from the Home screen select *Library*. Recordings can be listed by the channel or date/time recorded.

To setup or edit a scheduled recording on your Stiletto 10, from the Home screen use the ● Media Dial to highlight *Recording* and press the ● Select button.

SCHEDULING A RECORDING

To schedule a recording, select *Setup New Recording* from the Recording menu. (Figure 38) The *New Recording* screen allows you to set the parameters of the recording. (Figure 39) Use the **Media Dial** to highlight a parameter and press the **Select** button. Then use the **Media Dial** to scroll the list until the correct selection is highlighted, and press the **Select** button to select it. When complete, select *Done*.

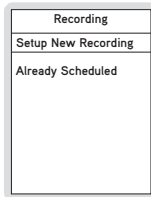

Figure 38

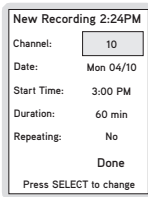

Figure 39

The following table describes each parameter of the scheduled recording.

Parameter	Description	Notes
Channel	Any SIRIUS broadcast channel may be selected	If a channel which has been locked with the parental control feature is selected, the password must be entered before you can listen to the recording
Date	The date of the recording	Dates may be selected from the present date to 4 weeks in the future
Start Time	The time of day the recording will begin	If the date and time chosen has already passed, you will receive a warning when you attempt to save the scheduled recording
Duration	The amount of time to record	Recording times of 5 minutes to 6 hours may be selected

Parameter	Description	Notes
Repeating	The recording can be set to repeat at scheduled intervals	<p>No: The recording will take place once at the specified time/date</p> <p>Weekly: The recording will take place every seven days at the specified time</p> <p>Daily: The recording will take place every day at the specified time</p> <p>Mon - Fri: The recording will take place every Monday through Friday at the specified time</p> <p>Sat - Sun: The recording will take place every Saturday and Sunday at the specified time</p>
Keep Last	For a repeating recording, you may specify how many previously recorded shows to keep	<p>1,2,3,5,10 Shows: Keeps the selected number of previous recordings</p> <p>All Shows: Keeps all previous recordings</p>

If there is not enough memory to complete a scheduled recording, older recordings will be automatically deleted to make room for the new recording.

Note: Scheduled recordings on multiple channels cannot happen at the same time. If an attempt is made to create a scheduled recording which will conflict with an existing one, the *Recording Conflict* error message will be displayed and give you the option to either cancel the older conflicting recording or change the settings of the new recording.

EDITING A SCHEDULED RECORDING

Once you've set up a scheduled recording, you can review and edit the recording settings by choosing *Already Scheduled* from the Recording menu. (Figure 38) Selecting this option will display a list of all recordings already scheduled. (Figure 40) Selecting a scheduled recording from the list will take you to the *Edit Recording* screen and allow you to make changes to the parameters for that recording. (Figure 41)

Already Scheduled		
Weekdays	7:55 AM	12
Every Mon	1:00 PM	35

Figure 40

Edit Recording 7:30AM	
Channel:	12
Date:	Mon 04/24
Start Time:	7:55 AM
Duration:	54 min
Repeating:	Mon - Fri
Keep Last:	All Shows
DONE	
Press SELECT to change	



Figure 41



Settings

Settings allows you make changes to the global settings of your Stiletto 10 and personalize your experience.

The following table describes each menu item and associated settings. The main Settings menu items are shown in bold text.

Menu Item	Options	Description
Artist & Song Seek (<i>Settings → Artist & Song Seek →</i>)		
Seek Alerts	On or Off	Turns Seek Alerts On or Off
Artist Seek List	Remove Artists	Highlight an artist name and press the  Options button to remove the artist from the list
Song Seek List	Remove Songs	Highlight a song title and press the  Options button to remove the song from the list

Menu Item	Options	Description
Audio & Display (<i>Settings → Audio & Display →</i>)		
Brightness	5 – 100%	Adjusts the brightness of the display screen A dimmer setting will prolong battery life
Backlight Timer	2, 5, 10, or 30 Seconds	Adjusts how long the backlight of the display screen remains on after no buttons are pressed A shorter setting will prolong battery life
Say Chan Name	On or Off	Chooses whether the channel names are spo- ken as you browse lists of channels
System Sounds	On or Off	Chooses whether the system sounds, beeps, and other tones are audible
System Volume	0 – 100%	Adjusts the volume of the system sounds and spoken channel names
Channels (<i>Settings → Channels →</i>)		
Hidden Channels	Choose Channels	Selects (or de-selects) channels to be hidden in channel lists
Hidden Genres	Choose Genres	Selects (or de-selects) genres to be hidden in genre lists
Device (<i>Settings → Device →</i>)		
Sirius ID	(none)	Displays the SIRIUS ID (SID) number of the Stiletto 10 This is a unique identification number assigned to your Stiletto 10. You'll need this number when you activate your Sirius Satellite Radio service

Menu Item	Options	Description
Antenna Aiming	(none)	Displays the strength of the SIRIUS signal being received from the satellites and terrestrial transmitters
Time Zone	Newfoundland Atlantic Eastern Time Indiana (East) Central Time Mountain Time Arizona Pacific Time	Sets the time zone in which you reside The Stiletto is set to Eastern Daylight Time by default
Memory Usage	(none)	Displays information on how much of the Stiletto 10's memory is being used
Device Info	(none)	Displays information about the model number, and software and hardware versions of your Stiletto 10
Legal Info	(none)	Provides legal and copyright information for the Stiletto 10

Menu Item	Options	Description
Reset and Erase	Yes or No	Resets all the settings of the Stiletto 10 to the factory defaults: <ul style="list-style-type: none"> – All presets are erased – Display brightness is set to 80% – FM Transmitter is set to ON – Hidden channels are added back – Favourite teams for game alerts are erased – Game Alert is set to ON – Sports Ticker is set to ON – Clock is set to Eastern time zone – Jump is set to none – Speak Channel Name is set to ON – System Sounds are set to ON – All recordings scheduled are cancelled – Channels locked with Parental Controls are unlocked – Parental Controls password is cleared – All items in the Library are erased <p>Note: If a parental control password has been set, you'll be prompted to enter the password before you can proceed with the reset</p>
Dock (<i>Settings</i> → <i>Dock</i> →)		
FM Transmit	On or Off	Selects whether the FM transmitter is turned on or off when the Stiletto 10 is in a docking station

Menu Item	Options	Description
Parental Controls (<i>Settings → Parental Controls →</i>)		
Parental Controls	On or Off	Selects whether the parental controls are enabled or disabled If On is selected, you will be prompted to select a 4-digit password
Locked Channels	Choose Channels	Individual channels may be selected (or de-selected) for locking Locked channels will have the  lock icon displayed with the channel name If unlocking channels, you will be prompted to enter the 4-digit password before they can be unlocked
Radio Replays (<i>Settings → Radio Replays →</i>)		
Radio Replays	On or Off	Selects whether the Stiletto 10 should automatically save content for Radio Replays
Sports (<i>Settings → Sports →</i>)		
Favourite Teams	Choose Teams	Allows you to select your favourite teams for Game Alerts
Game Alerts	On or Off	Selects whether the Game Alert feature is enabled or disabled
Sports Ticker	On or Off	Selects whether the Sports Ticker feature is enabled or disabled

Vehicle Docking Station Installation & Use

SIRIUS suggests professional installation of this product in your vehicle. Professional installation provides an experienced technician to install this product in your vehicle, advice for selecting a suitable mounting location, installation of the antenna, and routing all the necessary wires and cables. If the FM reception within your vehicle proves to be poor, an installer will have the necessary accessories to install an optional FM relay switch, or an audio cable to connect the audio output of the Stiletto 10 directly to your vehicle's audio system. Ask your SIRIUS retailer if they provide professional installation services, or can recommend a professional installation service.

Installing the Vehicle Docking Station

When installing the dock in your vehicle, choose a location in your vehicle where the unit will not block your vision, interfere with the vehicle controls, or obstruct the air bag. The location should be easily accessible and provide good visibility of the display, and should not be located where it will be in direct sunlight which will affect the visibility of the display screen. The left side of the vehicle dock which has the  FM button and the locking button should also not be obstructed.

The mounting accessories necessary to install the dock in a vehicle are provided. Figure 1 shows two examples of the Stiletto 10 mounted in a vehicle: **A** is the console mount method using the adhesive mount, and **B** is the vent mount method.

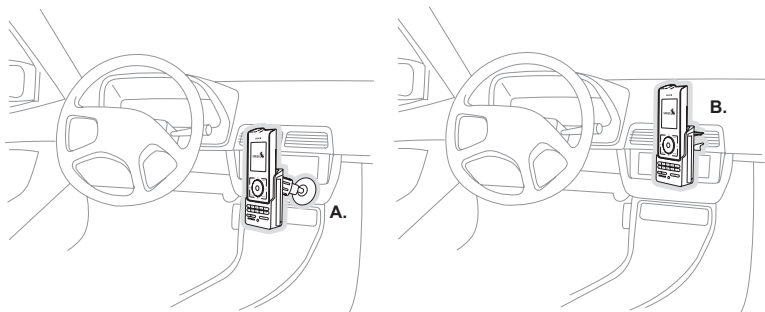

Figure 1

Depending upon the mounting method you select, the mount should be assembled as described in one of the following two sections.

Console Mount Method (A)

To assemble and mount the vehicle dock for the console mount method **A** as shown in Figure 1:

1. Attach the adhesive foot to the vehicle dock using the provided screws, placing the finger grip between the adhesive dock and the vehicle dock. (Figure 2)
2. Before adhering the mount to the console, be sure to select your mounting position carefully because once the mount has been adhered to a surface, it will not be possible to remove it and adhere it again.
3. Clean the selected mounting surface area in the vehicle with the alcohol swab.
4. Unscrew the adhesive foot from the mounting bracket. Peel the protective material off the adhesive on the foot and press the foot firmly against the vehicle surface.
5. The adhesive mount should then be allowed to adhere for a minimum of 2-4 hours before use. Best adhesion occurs after 24 hours. When the adhesive foot has achieved sufficient adhesion, reattach the vehicle dock to the foot.

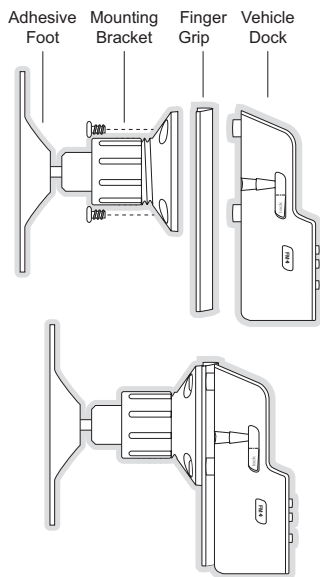

Figure 2

Vent Mount Method (B)

To assemble and mount the vehicle dock for the vent mount method **B** as shown in Figure 1:

1. Assemble the vent mount clip as shown in Figure 3. Note that the lower arm may be attached in two different positions. You should assemble the vent clip in the configuration that works best in your particular vehicle. Figure 3 illustrates both possible configurations of the vent clip.
2. Attach the vent clip to the vehicle dock using the provided screws, placing the finger grip between the vent clip and the vehicle dock. (Figure 4)
3. Slide the vent clip portion of the mount into a vent in your vehicle, insuring that one of the vent louvers slides between the upper and lower portions of the two clip arms, and hooks the rear of the louver.

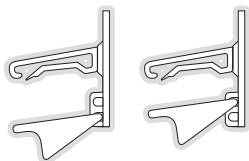

Figure 3

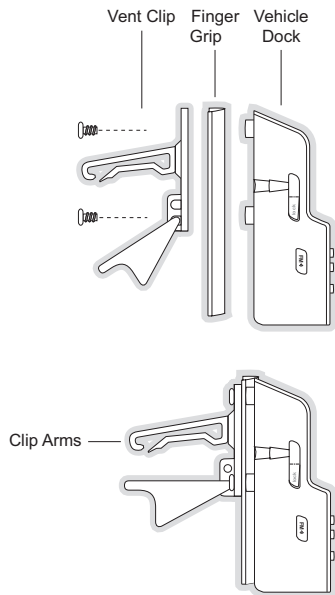

Figure 4

Installing the Antenna

The optimum mounting location for the magnetic antenna is on the roof of the vehicle, with a minimum unobstructed area of 12 inches by 12 inches, and exactly 6½ inches from the rear roof edge of the vehicle (the length of the rubber antenna cable cover/tail). It is important to avoid any obstructions that will block the SIRIUS signal, obstructions such as a roof rack, a sunroof, roof mounted cargo containers, or other antennas. For convertible vehicles, the antenna should be installed on the trunk lid.

For best performance, it is recommended that the antenna be installed with the rubber antenna cable cover/tail. This rubber antenna cable cover/tail provides two benefits: first, it positions the antenna the recommended distance from the rear window, rear door/hatch, or trunk edge to give the antenna the best view of the sky. Secondly, it conceals and protects the exposed antenna cable. The rubber antenna cable cover/tail has adhesive strips that hold it securely in place.

The following illustrations show the recommended mounting locations of the antenna for several types of vehicles. (Figure 5) Follow these recommendations for best performance from the antenna.

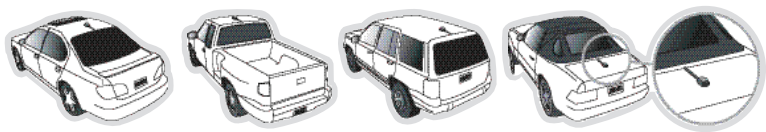

Figure 5

Sedan/Coupe. Mount the antenna along the rear center-line of the vehicle roof, located at the rear of the roof near the rear window.

Pickup Truck. Mount the antenna along the rear center-line of the cab roof, located at the rear of the roof near the rear window.

SUV/Mini-Van. Mount the antenna along the rear center-line of the vehicle roof, located at the rear of the roof near the rear door/hatch.

Convertible. Mount the antenna along the center-line of the trunk lid, with the rubber antenna cable cover/tail directed toward the rear window.

When you have selected a suitable mounting location, clean the area where the antenna and rubber antenna cable cover/tail will be mounted with the supplied alcohol swab.

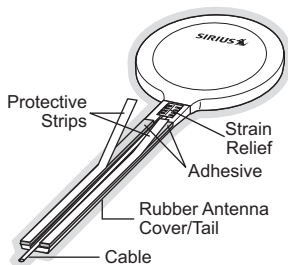

Figure 6

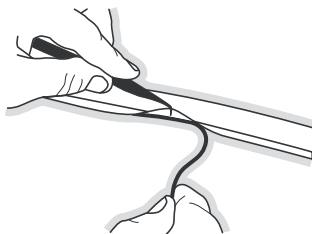

Figure 7

Connect the rubber antenna cable cover/tail to the antenna cable, making sure that the strain-relief on the antenna sits into the rubber antenna cable cover/tail groove. (Figure 6) Route the antenna cable through the wire channel in the rubber antenna cable cover/tail. Do not remove the protective strips yet.

Temporarily position the antenna and rubber antenna cable cover/tail in the selected mounting area and route the cable from the antenna to the vehicle's interior by tucking it underneath the rubber molding around rear window, as shown in Figure 7.

Route the cable from the lowest point of the rear window into the trunk. Take advantage of any existing cable channels or wiring conduits. For SUVs, mini-vans and 5-door vehicles, bring the cable into the vehicle under the rubber molding for the tailgate, and continue under the interior trim.

From the trunk, or rear of the vehicle, route the cable around the passenger compartment and to the front of the vehicle, to the receiver. Take care not pull the cable across sharp edges that could damage it, and keep it away from areas where it might entangle feet. Coil any

excess antenna cable in a location where it can be hidden. Connect the antenna cable to the **ANT** connection at the rear of the vehicle dock. (Refer to Figure 2 on page 16 for the location of this connector.)

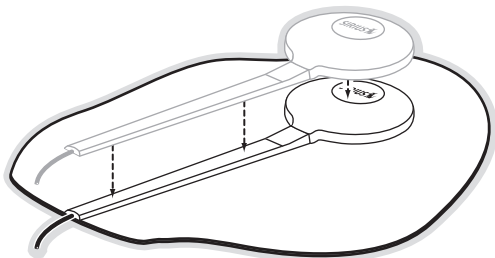

Figure 8

Once the antenna cable is routed through the vehicle, and you are satisfied with the cable routing, peel the protective material from the adhesive strips and press the rubber antenna cable cover/tail firmly into place on the vehicle. Double check that the location of the antenna and rubber antenna cable cover/tail are correct, and continue to press firmly down on rubber antenna cable cover/tail for another 30 seconds. (Figure 8) At room temperature (68 degrees), maximum adhesion usually occurs within 72 hours. During this period, avoid car washes and other contact with the antenna and rubber antenna cable cover/tail.

Connecting the Cigarette Lighter Adapter

Connect the provided cigarette lighter adapter to the **DC 5V** connection at the rear of the vehicle dock. (Refer to Figure 2 on page 16 for the location of this connector.)

Do not use any other power adapter for the Stiletto 10, or connect it directly to the vehicle's power. Doing so will damage the Stiletto 10. Using anything other than the supplied cigarette lighter adapter to power the vehicle dock will void the warranty.

Docking and Un-docking the Stiletto 10

When docking the Stiletto 10 be sure the Lock button of the vehicle docking station is in the unlocked position. (Refer to Figure 2 on page 16 for the location of the Lock button.) Grasp the vehicle dock with your free hand and place the Stiletto 10 into the dock, as shown in Figure 9, and slide it down until it is fully seated. Place the Lock button into the locked position to secure the Stiletto 10 in the dock.

To remove the Stiletto 10 from the vehicle dock place the Lock button in the unlocked position. Grasp the dock with your free hand and pull the Stiletto 10 up until it disengages from the dock.

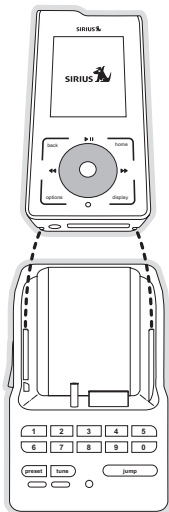

Figure 9

Selecting an FM Frequency

To listen to the audio from the Stiletto 10 using your vehicle's FM radio, you will need to tune the FM radio in your vehicle and the FM transmitter in the Stiletto 10 to the same FM frequency. The FM transmitter in the Stiletto 10 defaults to 88.1 MHz, so you can begin by tuning your vehicle's FM radio to 88.1 MHz. If there is an FM station broadcasting on that frequency, you will have to search for a different FM frequency to use, and then change the FM frequency that the Stiletto 10 will use to transmit.

To change the FM frequency:

1. Press the **FM** button on the left side of the vehicle dock. (Refer to Figure 2 on page 16 for the location of the FM button.)
2. Use the **Media Dial** to select a new FM frequency (Figure 10).
OR
Press one of the 0–9 buttons to recall an FM preset (Figure 11).
3. Press the **Select** button. The Stiletto 10 will now transmit on the selected FM frequency.

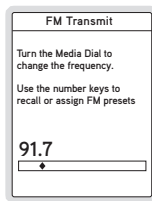

Figure 10

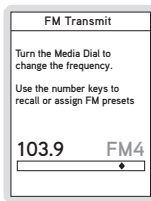

Figure 11



To assign FM frequencies for the FM presets:

1. Press the **FM** button on the left side of the vehicle dock.
2. Use the **Media Dial** to select an FM frequency.
3. Press and hold the preset number (0–9) in which you want to store the selected FM frequency. (Figure 11) Repeat steps 2 and 3 to assign additional FM presets.
4. Press the **Select** button to exit and transmit on the selected FM frequency, or press the **FM** button to simply exit.



Presets

Channel presets may be selected using the vehicle dock to tune to a channel by pushing the 0–9 buttons when the dock is in the preset mode. The Stiletto 10 must be in the Satellite mode to select presets.

To select to a preset:

1. Press the  Preset button on the vehicle dock. The preset mode indicator light will indicate that the preset mode is active.
2. Select the desired preset band (A, B, or C) by repeatedly pressing the  Preset button until the desired preset band is displayed. (Figure 12)
3. Press one of the 0–9 buttons to select the desired preset.

OR

Use the  Media Dial to highlight a preset and press the  Select button. (Figure 13)

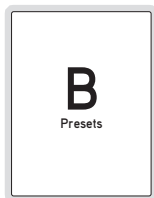

Figure 12



Figure 13

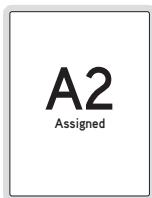



Figure 14

To save a preset:

1. Press the  Preset button on the vehicle dock. The preset mode indicator light will indicate that the preset mode is active.
2. Select the desired preset band (A, B, or C) by repeatedly pressing the  Preset button until the desired preset band is displayed. (Figure 12)
3. Press and hold one of the 0–9 buttons to save the desired preset. (Figure 14)

Direct Channel Tuning

Channels may be tuned directly by entering the channel number using the 0–9 buttons on the vehicle dock when the dock is in the tune mode. The Stiletto 10 must be in the Satellite mode to select channels. To directly tune a channel:

1. Press the  Tune button on the vehicle dock. (Figure 15) The tune mode indicator light will indicate that the tune mode is active.
2. Enter the channel number of the desired channel. If a 3-digit channel number is entered, the channel will be tuned immediately. If only one or two digits are entered, the channel will be tuned after a slight pause. (Figure 16)



Figure 15



Figure 16

My Sirius Studio Software Installation

The My Sirius Studio software included with your Stiletto 10 allows you to connect your Stiletto 10 to your PC computer. The software requires your PC computer to be using the Microsoft Windows XP operating system with Service Pack 2 installed.

Periodically connecting the Stiletto 10 to your PC computer will insure that your Stiletto has the latest device software updates. If a software update is available, it will be automatically loaded to your Stiletto when connected.

The software may also be used to stream SIRIUS music channels over the Internet.

Important: The My Sirius Studio software must be installed **before** connecting the Stiletto 10 to your PC computer.

To install the My Sirius Studio software:

1. Place the My Sirius Studio software CD-ROM into your PC computer's CD-ROM drive to start the software installation.



SiriusStudioSetup





2. If the installation does not begin automatically, double click the *SiriusStudioSetup* icon to begin the installation.
3. Follow the prompts of the software to complete the installation.

When the PC computer has rebooted, the My Sirius Studio software will be ready to use. Please refer to the user guide included on the software CD-ROM for instructions on using the software.

Troubleshooting

Symptom	Solution
Stiletto 10 does not power on	Check the battery to be sure it is installed correctly. Charge the battery. Check that the Stiletto 10 is properly seated in the dock. Check the cigarette lighter adapter to be sure it's seated in the cigarette lighter receptacle, and connected to the vehicle dock.
Stiletto 10 displays: <i>Acquiring Signal</i>	The Stiletto 10 is searching for a satellite signal. Check for obstacles over or around the satellite antenna. Change your location to eliminate nearby obstacles such as buildings, overhangs, bridges, overpasses, etc.
Stiletto 10 displays <i>No Antenna</i>	The satellite antenna is not connected to the vehicle dock. Check the satellite antenna connection to the dock. Check that the Stiletto 10 is properly seated in the dock.
Stiletto 10 displays: <i>No Signal</i>	No satellite signal is being received. Check that the Stiletto 10 is properly seated in the dock. Check for obstacles over or around the satellite antenna. Change the vehicle location to eliminate nearby obstacles (bridges, overpasses, etc.).
Audio static or loss of clarity	The FM frequency contains static. Locate a quiet FM frequency on your vehicle radio and set the FM transmitter frequency of the Stiletto 10 to match. If using the Line Out audio connector, check the cable connections.

Troubleshooting *Continued*

Symptom	Solution
Audio starts and stops	The satellite signal is weak. Check for obstacles over or around the satellite antenna. Change your location to eliminate nearby obstacles such as buildings, overhangs, bridges, overpasses, etc.
No sound	When in the vehicle dock: Check if the FM radio is set to the wrong frequency. Tune the vehicle FM radio and the Stiletto 10 to the same FM frequency. Check if the FM transmitter in the Stiletto 10 is turned off. Turn the FM transmitter on. If using the Line Out audio connector, check the cable connections. When not in a dock: Check that the ear buds are plugged into the headphone jack securely.
The Stiletto 10 will not start up or displays ERROR	The software on the Stiletto 10 has been damaged. Connect the Stiletto 10 to your PC computer using the USB cable, and use the My Sirius Studio software to download new software to the device. Follow the instructions included on the software CD-ROM.
The Stiletto 10 does not respond to the Media Dial and other buttons	The Stiletto is locked. Slide the  Power/Lock switch to the center position. Slide and hold the  Power/Lock switch down for 5 seconds which will turn the Stiletto 10 off. Then slide the  Power/Lock switch down and release it. If none of these solutions works, remove the battery, wait 10 seconds, replace the battery, and slide the  Power/Lock switch down and release it.

Optional Accessories

The following optional accessories are available for purchase from your SIRIUS retailer to maximize your SIRIUS Stiletto experience.

Vehicle Kit (Model SLV1C)

If you plan to use your Stiletto 10 in another vehicle, you can purchase another Stiletto Vehicle Kit. The Stiletto Vehicle Kit will maximize your safety and provide convenience by positioning the Stiletto for easy viewing and operation. Whether you choose the FM wireless or direct connect option when installing the kit, the rich digital sound of SIRIUS radio will play through your vehicle's stereo system. The dock features preset and direct tune buttons for quickly tuning to your favourite channels, and a jump button for tuning directly to the traffic/weather channel for your area. It is designed for quick and easy self-installation and includes a vent and dash mount for flexible mounting options.



The kit includes a compact docking cradle that rapidly charges your Stiletto's battery, a remote control, dash and vent mounts, cigarette lighter adapter, and a magnetic antenna with 21' of cable. Detailed installation instructions are included with the kit.

Home Kit (Model SLH1C)

The Stiletto Home Kit is a compact docking cradle that provides everything you need to use the Stiletto in your home or office. The sleek docking cradle provides a convenient way to charge your Stiletto's battery along with an extra slot for charging a spare battery. The included indoor/outdoor antenna provides improved reception, while audio cables enable you to connect the Stiletto to amplified speakers or a home entertainment system.

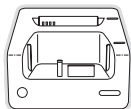

The kit includes a compact tabletop/desktop docking cradle with FM output for wireless connectivity, a remote control, audio cables, an adjustable indoor/outdoor windowsill antenna with 20' of cable, and an AC Adapter. Detailed installation instructions are included with the kit.

Executive Sound System (Model SLEX1C)

The Stiletto Executive Sound System is a portable docking station and audio system for use with the Stiletto radio. With the built-in amplifier and speakers, the system delivers rich, powerful sound indoors or outdoors, and features an auxiliary input for other audio devices. Included with the system is an adjustable indoor/outdoor windowsill antenna with 20' of cable and an AC adapter.

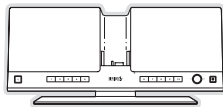

Specifications

Satellite Frequencies	2322.293/2330.207 MHz
Terrestrial Frequencies	2326.250 MHz
Power Requirements	5 Volts, 2.0A Negative Ground, DC
Operation Temperature	-5° C to +40° C (23° to 104° F)
Audio Interface	1/8" / 3.5 mm Stereo Jack
Headphone Output	20mW @ 16 ohms
Signal-to-noise (S/N)	90dB (MP3)
Radio Dimensions (Height x Width x Depth)	116 mm x 53 mm x 18.25 mm (4.5" x 2.0" x 0.7")
Radio Weight	132 g (4.6 oz.) with Slim Battery
Memory Capacity	256 MB
Internal Antenna Type	Integrated, Low Profile Patch

Warranty

12 Month Warranty

SIRIUS Canada Inc. (the "Company") warrants to the original retail purchaser of this product that should this product or any part thereof, under normal use and conditions, be proven defective in material or workmanship within 12 months from the date of original purchase, such defect(s) will be replaced with new or reconditioned product (at the Company's option) without charge for parts and labor. To obtain replacement within the terms of this Warranty, the product is to be delivered with proof of warranty coverage (e.g. dated bill of sale), specification of defect(s), transportation prepaid, to the location shown below under WARRANTY RETURN.

This Warranty does not extend to the elimination of externally generated static or noise, to correction of antenna problems, to costs incurred for installation, removal or reinstallation of the product, or to damage to tapes, compact discs, speakers, accessories, or vehicle electrical systems.

This Warranty does not apply to any product or part thereof which, in the opinion of the Company, has suffered or been damaged through alteration, improper installation, mishandling, misuse, neglect, accident, or by removal or defacement of the factory serial number/bar code label(s). THE EXTENT OF THE COMPANY'S LIABILITY UNDER THIS WARRANTY IS LIMITED TO THE REPAIR OR REPLACEMENT PROVIDED ABOVE AND, IN NO EVENT, SHALL THE COMPANY'S LIABILITY EXCEED THE PURCHASE PRICE PAID BY PURCHASER FOR THE PRODUCT.

This Warranty is in lieu of all other express warranties or liabilities. ANY IMPLIED WARRANTIES, INCLUDING ANY IMPLIED WARRANTY OF MERCHANTABILITY, SHALL BE LIMITED TO THE DURATION OF THIS WRITTEN WARRANTY. ANY ACTION FOR BREACH OF ANY WARRANTY HEREUNDER INCLUDING ANY IMPLIED WARRANTY OF MERCHANTABILITY MUST BE BROUGHT WITHIN A PERIOD OF 48 MONTHS FROM DATE OF ORIGINAL PURCHASE. IN NO CASE SHALL THE COMPANY BE LIABLE FOR ANY CONSEQUENTIAL OR INCIDENTAL DAMAGES FOR BREACH OF THIS OR ANY OTHER WARRANTY, EXPRESS OR IMPLIED, WHATSOEVER. No person or representative is authorized to assume for the Company any liability other than expressed herein in connection with the sale of this product. Some states do not allow limitations on how long an implied warranty lasts or the exclusion or limitation of incidental or consequential damage so the above limitations or exclusions may not apply to you. This Warranty gives you specific legal rights and you may also have other rights which vary from state to state.

WARRANTY RETURN: To obtain a replacement within the terms of this Warranty, please return product to an authorized Sirius Canada retailer or call Erikson Consumer Customer Service at (800) 567-3275 for an authorized Sirius retailer near you; proof of purchase and description of defect are required. Products to be returned to an approved warranty station must be shipped freight prepaid.

End User License Agreement

SIRIUS CANADA INC.

END USER LICENSE AGREEMENT (EULA)

This End User License Agreement (this "EULA") sets forth the agreement between you and Sirius Canada Inc. ("Sirius") for the use of the software in Stiletto Sirius satellite radio receivers (the "Receiver Software"), the My Sirius Studio computer software (the "Computer Software" and, together with the Receiver Software, the "Software") and their use with Stiletto Series Sirius satellite radio receiver and accessories (the "Receiver") and Sirius' satellite radio service (the "Sirius Service").

In addition, for your use of the Sirius Service, you agree to be bound by the "Terms & Conditions of Service" set forth at: <http://www.siriuscanada.ca> (the "Terms and Conditions").

YOU ACKNOWLEDGE AND AGREE THAT YOU HAVE READ AND UNDERSTAND THIS EULA. BY USING THE RECEIVER AND THE RECEIVER SOFTWARE, CLICKING ON THE "ACCEPT" BUTTON TO INSTALL THE COMPUTER SOFTWARE, AND/OR INSTALLING, COPYING OR OTHERWISE USING THE COMPUTER SOFTWARE, YOU AGREE TO BE BOUND BY THE TERMS OF THIS EULA. IF YOU DO NOT AGREE TO THE TERMS OF THIS EULA, CLICK ON THE "CANCEL" BUTTON IF YOU ARE INSTALLING THE COMPUTER SOFTWARE SO THAT IT IS NOT INSTALLED, AND DO NOT USE THE RECEIVER.

1. **GRANT OF LICENSE.** Sirius hereby grants to you a non-exclusive, limited, license to use the Software and any related documentation (the "Documentation"). You may: (a) use the Receiver Software in object code form only as fully integrated into the Receiver in order to operate the Receiver for its usual purpose, (b) use the Computer Software simultaneously on up to three computers and (c) copy the Computer Software for back-up and archival purposes; provided that any copy must contain all of the original Software's proprietary notices. Sirius, its partners and suppliers, including without limitation, Microsoft Corporation ("Microsoft"), ZING Systems, Inc. ("ZING"), and their respective partners and suppliers, retain all rights not expressly granted herein, including without limitation, all world-wide patent, copyright, trademark, trade secret and other proprietary rights associated with the Software. You agree that Sirius' partners and suppliers (including Microsoft and ZING) are third party beneficiaries of this EULA and may enforce your performance of its terms. This product is protected by certain intellectual property rights of Microsoft. Use or distribution of such technology outside of this product is prohibited without a license from Microsoft.

2. **LICENSE RESTRICTIONS.** (a) You must be at least 18 years old to assume the obligations set forth in this EULA. Minors may use the Software and the Documentation only if a parent or legal guardian assumes the obligations set forth in this EULA and thereby assumes full responsibility for the minor's use of the Software and the Documentation.

(b) You may not: (i) permit other individuals to use the Computer Software; (ii) modify, translate, reverse engineer, decompile, extract source code from, disassemble (except to the extent that this restriction is expressly prohibited by law), reproduce, or create derivative works based upon the Software or the Documentation; (iii) copy the Software or the Documentation (except as permitted by Section 1(c)); (iv) rent, lease, publicly display, transfer, or otherwise transfer rights to the Software or the Documentation and/or (v) remove any proprietary notices or labels on the Software or the Documentation. Any violations of this Section 2(b) will immediately terminate your license to the Software and the Documentation.

(c) You may use the Software and the Documentation only in a manner that complies with all applicable laws in the jurisdictions in which you use the Software and the Documentation, including without limitation, applicable restrictions concerning copyright and other intellectual property rights.

(d) You may use the Software only for your private, non-commercial use. You may not use the Software in any way to provide, or as part of, any commercial service or application. Copies of content files, including without limitation songs and other audio recordings, which are stored and/or transferred using the Software, and which are protected by the copyright laws or related laws of any jurisdiction, are for your own personal use only and you may not publicly perform them or distribute them to third parties.

(e) By storing content on the Receiver, you are making a digital copy. You may not use the Receiver or the Software in an attempt to, or in conjunction with, any device, program or service designed to circumvent technological measures employed to control access to, or the rights in, a content file or other work protected by the copyright laws of any jurisdiction.

(f) The Software embodies a serial copying management system required by the laws of the United States. You may not circum-

vent or attempt to circumvent this system by any means.

(g) You shall not export or re-export the Software or the Receiver without the appropriate U.S. or foreign government licenses.

(h) MPEG Layer-3 audio coding technology licensed from Fraunhofer IIS and Thomson. Supply of the Receiver and the Software does not convey a license nor imply any right to distribute content created with this product in revenue-generating broadcast systems (terrestrial, satellite, cable and/or other distribution channels), streaming applications (via Internet, intranets and/or other networks), other content distribution systems (pay-audio or audio-on-demand applications and the like) or on physical media (compact discs, digital versatile discs, semiconductor chips, hard drives, memory cards and the like). An independent license for such use is required. For details, please visit <http://mp3licensing.com>."

3. COMMUNICATIONS FEATURES; USE OF INFORMATION. (a) The Software includes functionality that may automatically communicate information to Sirius, its partners and suppliers over the Internet as part of its normal operation. The Software may also contain user-visible features that interact and communicate with internet services operated by Sirius, its partners and suppliers. An initial list of the communications features is listed below. The communications features may be changed by any updates of the Software that you install. By installing and/or using the Software and any related updates, you agree to permit the installation and use of the communications features. You are responsible for any telecommunications or other connectivity charges incurred through use of the Software.

(b) Once you install the Software and/or connect the Receiver (wired or wirelessly), the Software may provide Sirius with information regarding the Receiver, including electronic identification number of the Receiver (the "ESN"). The Software may also provide Sirius with the following non-personally identifying usage information, including, but not limited to: Receiver hardware actions (e.g., keys pressed, reboots, crashes, upgrades, resets), the hardware and software revision numbers on the Receiver, the channels/streams of the Sirius Service that you set/delete as presets/favorites on the Receiver, use of parental controls, battery level, available space on the Receiver, connection method and signal strength. Sirius will not combine this utilization information with any personally identifiable information. Instead, this information will be collected and analyzed to evaluate overall performance of the software and the related products, for quality control and product enhancement purposes and to keep statistics on the aggregated anonymous use of the Software and/or the Sirius Service. Your personally identifiable information will not be collected in any way through this software, nor will you personally identifiable information held by Sirius for other purposes (such as your subscription information) be combined with this utilization data in any way.

4. DIGITAL RIGHTS MANAGEMENT. (a) The Software and the Device use the Microsoft digital rights management technology for Windows Media ("WM-DRM") to protect the integrity of Sirius and third party content ("Secure Content") so that the intellectual property, including without limitation, the copyright, in such content is not misappropriated. Portions of the WM DRM software (the "WM-DRM Software") use WM-DRM to transfer or play Secure Content. If the WM-DRM Software's security has been compromised, owners of Secure Content ("Secure Content Owners") may request that Microsoft revoke the WM-DRM Software's right to copy, display, transfer, and/or play Secure Content. Revocation does not alter the WM-DRM Software's ability to play unprotected content. A list of revoked WM-DRM Software is sent to your computer whenever you download a license for Secure Content from the Internet. Microsoft may, in conjunction with such license, also download revocation lists onto your computer on behalf of Secure Content Owners. Secure Content Owners may also require you to upgrade some of the WM-DRM components distributed with the WM-DRM software ("WM-DRM Upgrades") before accessing their content. When you attempt to play such content, WM-DRM Software built by Microsoft may notify you that a WM-DRM Upgrade is required and then ask for your consent before the WM-DRM Upgrade is downloaded. WM-DRM Software used by third parties may do the same. You agree that Microsoft and other third parties may upgrade the WM-DRM Software without notice to you. If you decline an upgrade, you will not be able to access content that requires the WM-DRM Upgrade; provided that, you will still be able to access unprotected content and Secure Content that does not require the upgrade.

(b) You may not take any action to circumvent or defeat the security or content usage rules provided or enforced by the WM-DRM Software. Sirius is not responsible for the operation of the WM-DRM Software in any way, including without limitation, revocation of the WM-DRM Software's right to copy, display, transfer, and/or play Secure Content. Sirius is not responsible for any communications to or from any Secure Content Owner, or for the collection or use of information by any Secure Content Owner.

5. OWNERSHIP. All title, ownership, rights, and intellectual property rights in and to the Software and the Documentation shall remain in the property of Sirius and its licensors. The Software includes Microsoft Windows Media Technology. The Software is protected by the copyright laws of the United States and international copyright treaties.

6. WARRANTIES. (a) Sirius warrants that for a period of 90 days from the date of your acquisition the Software if operated as directed, will substantially achieve the functionality described in the Documentation and will be free from defects in material and workmanship. This warranty shall immediately terminate if the Software is used on or in conjunction with hardware or software other than the unmodified version of Receiver which the Software was designed to be used as described in the Documentation, any modifications are made to the Software during the warranty period, if the media is subjected to accident abuse or improper

use, and/or the terms of this EULA are breached. Sirius does not warrant that use of the Software will be uninterrupted or that the operation of the Software will be error-free or secure. Depending on manufacturer and model of your Receiver, you may or may not be entitled to upgrades of the Receiver Software. Please check your Receiver owner's manual for further information.

(b) SIRIUS LICENSES THE SOFTWARE TO YOU "AS IS", AND TO THE MAXIMUM EXTENT PERMITTED BY APPLICABLE LAW SIRIUS, ITS PARTNERS AND SUPPLIERS (INCLUDING MICROSOFT AND ZING) HEREBY DISCLAIM ALL OTHER WARRANTIES EITHER EXPRESS OR IMPLIED, INCLUDING WITHOUT LIMITATION IMPLIED WARRANTIES OF MERCHANTABILITY AND FITNESS FOR A PARTICULAR PURPOSE WITH REGARD TO THE SOFTWARE AND THE DOCUMENTATION. THIS LIMITED WARRANTY GIVES YOU SPECIFIC LEGAL RIGHTS; YOU MAY HAVE OTHER RIGHTS THAT VARY FROM STATE/JURISDICTION TO STATE/JURISDICTION.

(c) Sirius' sole liability for a breach of its warranties shall be in Sirius' sole discretion: (i) to replace your defective media, (ii) to advise you how to achieve substantially the same functionality with the Software as described in the Documentation through a procedure different from that set forth in the Documentation and/or (iii) if the above remedies are impracticable, to refund the license fee, if any, you paid for the Software. Repaired, corrected or replaced copies of the Software and the Documentation shall be covered by the same limited warranty for the period remaining under the warranty that covered the original copy of the Software or if longer for 30 days after the date Sirius either provided you with the repaired or replaced copy of the Software or advised you as to how to operate the Software so as to achieve the functionality described in the Documentation, whichever is applicable. Sirius will be obligated to honor its obligations in this Section 6(c) only if you inform Sirius of the problem with the Software during the applicable warranty period and provide evidence of the date you acquired the Software.

7. INDEMNIFICATION. (a) You shall defend, indemnify and hold harmless Sirius, its officers, directors and employees, from and against any losses, damages, fines and expenses, including without limitation, attorneys' fees and expenses, arising out of or relating to any claims that you have: (i) viewed, downloaded, encoded, compressed, copied or transmitted any in connection with the Software in violation of another party's rights or in violation of any law, or (ii) violated any terms of this EULA and/or the Terms and Conditions.

(b) If you are importing the Software from the United States, you shall defend, indemnify and hold harmless Sirius from and against any import and export duties or other claims arising from such importation.

8. LIMITATION OF LIABILITY. NEITHER SIRIUS, ITS PARTNERS, NOR SUPPLIERS (INCLUDING MICROSOFT AND ZING) IS RESPONSIBLE FOR ANY SPECIAL, INCIDENTAL, OR CONSEQUENTIAL DAMAGES OR LOSSES RELATING TO THE USE AND/OR PURCHASE OF THE SOFTWARE, THE DOCUMENTATION, THE RECEIVER AND/OR THE SIRIUS SERVICE, INCLUDING WITHOUT LIMITATION, COMPUTER FAILURE AND/OR MALFUNCTION, WHETHER BASED ON NEGLIGENCE OR OTHERWISE, AND WHETHER OR NOT SIRIUS OR SUCH SUPPLIER (INCLUDING MICROSOFT AND ZING) HAS BEEN ADVISED OF THE POSSIBILITY THEREOF. SIRIUS TOTAL LIABILITY TO YOU AND ANY OTHER PERSONS USING THE RECEIVER, THE SOFTWARE AND/OR THE DOCUMENTATION, REGARDLESS OF THE CAUSE, WILL IN NO EVENT EXCEED THE AMOUNTS THAT YOU HAVE PAID TO SIRIUS FOR THE RECEIVER, THE SOFTWARE AND THE DOCUMENTATION. THIS ALLOCATION OF RISK AND THE DISCLAIMER OF WARRANTIES IS REFLECTED IN SIRIUS' PRICES AND IS A FUNDAMENTAL ELEMENT OF SIRIUS AGREEMENT TO PROVIDE YOU WITH THE SOFTWARE AND THE DOCUMENTATION. YOU MAY HAVE GREATER RIGHTS THAN DESCRIBED ABOVE UNDER YOUR STATE'S LAWS.

9. TERMINATION. (a) This EULA will automatically terminate without notice if you fail to comply with any of its terms.

(b) This EULA may also terminate without notice to you in the event Sirius' or any of its partners or suppliers (including Microsoft and ZING) licenses for technology incorporated into the Software terminates.

(c) You may terminate this EULA at any time by providing Sirius with written notice of termination to: Sirius Satellite Radio Inc., 1221 Avenue of the Americas, 36th Floor, New York, New York 10020, Attention: My Sirius Studio/Stiletto Software Termination.

(d) Upon any termination of this EULA, you shall immediately discontinue use of the Software and shall within three days return to Sirius, or certify destruction of, all full or partial copies of the Software, documentation and related materials provided by Sirius. Your obligation to pay accrued charges and fees shall survive any termination of this License Agreement.

(e) Except for the license granted in paragraph 1, the terms of this EULA shall survive termination under this paragraph 9.

10. RESOLVING DISPUTES. In order to expedite and control the cost of disputes, you agree that any legal equitable claim (a "Claim") relating to the Software, the Documentation and/or this EULA, will be resolved as follows:

(a) Informal Resolution. You and Sirius will first try to resolve any Claim informally. Accordingly, neither you nor Sirius may start a formal proceeding (except for Claims described in Section 10(d)) for at least 60 days after one of us notifies the other of a Claim in writing. To initiate a Claim, you must send notice by U.S. mail to: Sirius Satellite Radio Inc., 1221 Avenue of the Americas, 36th Floor, New York, New York 10020, Attention: General Counsel. If Sirius initiates a Claim, notice will be sent to your address on file with Sirius.

(b) Formal Resolution. Except as provided in Section 10(d), if you and Sirius cannot resolve a Claim informally, any Claim either of

you or Sirius asserts will be resolved only by binding arbitration. The arbitration will be conducted under the Commercial Arbitration Rules of the American Arbitration Association (the "AAA Rules") that are in effect at the time the arbitration is initiated and under the rules set forth in this EULA. If there is a conflict between the AAA Rules and this EULA, this EULA will govern. **ARBITRATION MEANS THAT YOU WAIVE YOUR RIGHT TO A JURY TRIAL.** If you initiate an arbitration, you agree to pay a fee of \$125 or, if less and you notify Sirius in writing, the amount that you would pay to initiate a lawsuit against Sirius in the appropriate court of your state. Sirius agrees to pay any additional fee or deposit required by the American Arbitration Association in excess of your filing fee. Sirius also agrees to pay the costs of the arbitration proceeding up to a maximum of one-half day (four hours) of hearings. Other fees, such as attorney's fees, expenses, travel to the arbitration and the costs of a proceeding that goes beyond one-half day, will be paid in accordance with the AAA Rules. The arbitration will be held at a location within 100 miles of your residence unless you and Sirius both agree to another location. To start the arbitration, you or Sirius must do the following things:

) Write a demand for arbitration. The demand must include a description of the Claim and the amount of damages sought to be recovered;

(ii) Send three copies of the demand for arbitration plus the appropriate filing fee to: American Arbitration Association, 601 Pennsylvania Avenue, N.W., Suite 700, Washington, D.C. 20004; and

(iii) Send one copy of the demand for arbitration by U.S. mail to Sirius Satellite Radio Inc., 1221 Avenue of the Americas, 36th Floor, New York, New York 10020, Attention: General Counsel, or to your address on file with Sirius (if Sirius starts the arbitration).

(c) Binding Effect. In the arbitration proceeding, the arbitrator must follow applicable law, and any award may be challenged if the arbitrator fails to do so. The arbitrators shall not have the power, jurisdiction or authority to waive, amend and/or modify any of the terms or provisions of this EULA. The arbitrators shall enforce this EULA in accordance with its terms and provisions.

Otherwise, the arbitrator's decision is final and binding on all parties and may be enforced in any federal or state court that has jurisdiction. A court may sever any portion of this Section 9 that it finds to be unenforceable.

(d) Exceptions. Notwithstanding the foregoing, any: (i) dispute over the validity of intellectual property rights or Sirius licenses to operate its business; (ii) Claim based on Section 2(a) above; and (iii) dispute involving a violation of the Communications Act of 1934, 47 U.S.C. §605, or the Electronic Communications Privacy Act, 18 U.S.C. §§2510-2521, may be decided only by a court of competent jurisdiction.

11. MISCELLANEOUS. (a) Notice. Notices to you will be deemed given when deposited in the mail or when sent by email. Notices may be included in statements or other communications to you. Sirius may also provide notice to you by telephone, which will be deemed given when a message is left with you, someone answering the telephone at your residence or on an answering machine or voice mail system at your phone number on record with Sirius. Your notices to Sirius will be deemed given when Sirius receives them 1221 Avenue of the Americas, 36th Floor, New York, New York 10020, Attention: General Counsel.

(b) Applicable Law. The interpretation and enforcement of this EULA shall be governed by the internal laws of the State of New York. This EULA is subject to modification if required by such laws. Notwithstanding the foregoing, Section 10 shall be governed by the Federal Arbitration Act. You agree that the United Nations Convention on Contracts for the International Sale of Goods is specifically excluded from application to this EULA.

(c) Assignment. Except as set forth in this paragraph 11(c), you may not assign your rights and/or obligations under this EULA to any third party. If you sell or otherwise transfer the Receiver as a whole, you may transfer the Receiver Software as fully integrated into the Receiver; provided that you also supply this EULA to the purchaser or recipient of the Receiver, at which time all of your rights under this EULA will immediately cease. Sirius may assign its rights and/or obligations under this EULA to any third party without notice for any purpose, including without limitation, in the event of an acquisition, corporate reorganization, merger or sale of substantially all of Sirius' assets to another entity. You hereby consent to such assignment.

(d) No Waiver. No failure or delay on the part of Sirius, its partners or its suppliers (including Microsoft and ZING) in exercising any right, power or privilege hereunder and no course of dealing by Sirius, its partners or its suppliers (including Microsoft and ZING) shall operate as a waiver of any right, power or privilege hereunder.

(e) Other. This EULA constitutes the entire agreement between you and Sirius relating to your use of the Software and the Documentation. No salesperson or other representative is authorized to change it for you. If any provision is declared by a competent authority to be invalid, that provision will be deleted or modified to the extent necessary, and the rest of this EULA will remain enforceable.

12. THIRD PARTY LICENSES. The Software contains software, libraries and other tools provided by third parties, which are subject to the restrictions below.

(a) busybox. Copyright © 2006. Jef Poskanzer. busybox is distributed under the GNU General Public License. A copy of the GNU General Public License may be found at <http://www.gnu.org/copyleft/gpl.html>. Portions of the work were modified by Zing Systems, Inc. 2005-2006. The original and modified source code can be found at www.sirius.com/opensource. THIS

SOFTWARE IS PROVIDED BY THE AUTHOR(S) "AS IS" AND ANY EXPRESS OR IMPLIED WARRANTIES, INCLUDING, BUT NOT LIMITED TO, THE IMPLIED WARRANTIES OF MERCHANTABILITY AND FITNESS FOR A PARTICULAR PURPOSE ARE DISCLAIMED. IN NO EVENT SHALL THE AUTHOR(S) BE LIABLE FOR ANY DIRECT, INDIRECT, INCIDENTAL, SPECIAL, EXEMPLARY, OR CONSEQUENTIAL DAMAGES (INCLUDING, BUT NOT LIMITED TO, PROCUREMENT OF SUBSTITUTE GOODS OR SERVICES; LOSS OF USE, DATA, OR PROFITS; OR BUSINESS INTERRUPTION) HOWEVER CAUSED AND ON ANY THEORY OF LIABILITY, WHETHER IN CONTRACT, STRICT LIABILITY, OR TORT (INCLUDING NEGLIGENCE OR OTHERWISE) ARISING IN ANY WAY OUT OF THE USE OF THIS SOFTWARE, EVEN IF ADVISED OF THE POSSIBILITY OF SUCH DAMAGE.

(b) bzip2. Copyright © 1996-2005 Julian Seward. All rights reserved. Redistribution and use in source and binary forms, with or without modification, are permitted provided that the following conditions are met: Redistributions of source code must retain the above copyright notice, this list of conditions and the following disclaimer. The origin of this software must not be misrepresented; you must not claim that you wrote the original software. If you use this software in a product, an acknowledgment in the product documentation would be appreciated but is not required. Altered source versions must be plainly marked as such, and must not be misrepresented as being the original software. The name of the author may not be used to endorse or promote products derived from this software without specific prior written permission. THIS SOFTWARE IS PROVIDED BY THE AUTHOR "AS IS" AND ANY EXPRESS OR IMPLIED WARRANTIES, INCLUDING, BUT NOT LIMITED TO, THE IMPLIED WARRANTIES OF MERCHANTABILITY AND FITNESS FOR A PARTICULAR PURPOSE ARE DISCLAIMED. IN NO EVENT SHALL THE AUTHOR BE LIABLE FOR ANY DIRECT, INDIRECT, INCIDENTAL, SPECIAL, EXEMPLARY, OR CONSEQUENTIAL DAMAGES (INCLUDING, BUT NOT LIMITED TO, PROCUREMENT OF SUBSTITUTE GOODS OR SERVICES; LOSS OF USE, DATA, OR PROFITS; OR BUSINESS INTERRUPTION) HOWEVER CAUSED AND ON ANY THEORY OF LIABILITY, WHETHER IN CONTRACT, STRICT LIABILITY, OR TORT (INCLUDING NEGLIGENCE OR OTHERWISE) ARISING IN ANY WAY OUT OF THE USE OF THIS SOFTWARE, EVEN IF ADVISED OF THE POSSIBILITY OF SUCH DAMAGE.

(c) Curl. Curl is Copyright (c) 1996 - 2006, Daniel Stenberg, <daniel@haxx.se>. All rights reserved. Permission to use, copy, modify, and distribute this software for any purpose with or without fee is hereby granted, provided that the above copyright notice and this permission notice appear in all copies.

(d) Ezxmi. Ezxmi is Copyright 2004, 2005 Aaron Voisine. Permission is hereby granted, free of charge, to any person obtaining a copy of this software and associated documentation files (the "Software"), to deal in the Software without restriction, including without limitation the rights to use, copy, modify, merge, publish, distribute, sublicense, and/or sell copies of the Software, and to permit persons to whom the Software is furnished to do so, subject to the following conditions: The above copyright notice and this permission notice shall be included in all copies or substantial portions of the Software.

(e) FreeType. Portions of this software are copyright © 2006 The FreeType Project (www.freetype.org). All rights reserved.

(f) gpg. Copyright (c) 1998-2006 Free Software Foundation, Inc. gpg is distributed under the GNU General Public License. A copy of the GNU General Public License may be found at <http://www.gnu.org/copyleft/gpl.html>. The source code can be found at www.sirius.com/opensslource. THIS SOFTWARE IS PROVIDED BY THE AUTHOR(S) "AS IS" AND ANY EXPRESS OR IMPLIED WARRANTIES, INCLUDING, BUT NOT LIMITED TO, THE IMPLIED WARRANTIES OF MERCHANTABILITY AND FITNESS FOR A PARTICULAR PURPOSE ARE DISCLAIMED. IN NO EVENT SHALL THE AUTHOR(S) BE LIABLE FOR ANY DIRECT, INDIRECT, INCIDENTAL, SPECIAL, EXEMPLARY, OR CONSEQUENTIAL DAMAGES (INCLUDING, BUT NOT LIMITED TO, PROCUREMENT OF SUBSTITUTE GOODS OR SERVICES; LOSS OF USE, DATA, OR PROFITS; OR BUSINESS INTERRUPTION) HOWEVER CAUSED AND ON ANY THEORY OF LIABILITY, WHETHER IN CONTRACT, STRICT LIABILITY, OR TORT (INCLUDING NEGLIGENCE OR OTHERWISE) ARISING IN ANY WAY OUT OF THE USE OF THIS SOFTWARE, EVEN IF ADVISED OF THE POSSIBILITY OF SUCH DAMAGE.

(g) Linux. Linux is distributed under the GNU General Public License. A copy of the GNU General Public License may be found at <http://www.gnu.org/copyleft/gpl.html>. Portions of the work were modified by Zing Systems, Inc. 2005-2006. The original and modified source code can be found at www.sirius.com/opensslource. THIS SOFTWARE IS PROVIDED BY THE AUTHOR(S) "AS IS" AND ANY EXPRESS OR IMPLIED WARRANTIES, INCLUDING, BUT NOT LIMITED TO, THE IMPLIED WARRANTIES OF MERCHANTABILITY AND FITNESS FOR A PARTICULAR PURPOSE ARE DISCLAIMED. IN NO EVENT SHALL THE AUTHOR(S) BE LIABLE FOR ANY DIRECT, INDIRECT, INCIDENTAL, SPECIAL, EXEMPLARY, OR CONSEQUENTIAL DAMAGES (INCLUDING, BUT NOT LIMITED TO, PROCUREMENT OF SUBSTITUTE GOODS OR SERVICES; LOSS OF USE, DATA, OR PROFITS; OR BUSINESS INTERRUPTION) HOWEVER CAUSED AND ON ANY THEORY OF LIABILITY, WHETHER IN CONTRACT, STRICT LIABILITY, OR TORT (INCLUDING NEGLIGENCE OR OTHERWISE) ARISING IN ANY WAY OUT OF THE USE OF THIS SOFTWARE, EVEN IF ADVISED OF THE POSSIBILITY OF SUCH DAMAGE.

(h) lpng128, libpng versions 1.2.6, August 15, 2004, through 1.2.8, December 3, 2004, are Copyright (c) 2004 Glenn Randers-Pehrson, and are distributed according to the same disclaimer and license as libpng-1.2.5 with the following individual added to

the list of Contributing Authors: Cosmin Truta. libpng versions 1.0.7, July 1, 2000, through 1.2.5, October 3, 2002, are Copyright (c) 2000-2002 Glenn Randers-Pehrson, and are distributed according to the same disclaimer and license as libpng-1.0.6 with the following individuals added to the list of Contributing Authors: Simon-Pierre Cadieux, Eric S. Raymond, Gilles Vollant. libpng versions 0.97, January 1998, through 1.0.6, March 20, 2000, are Copyright (c) 1998, 1999, 2000 Glenn Randers-Pehrson, and are distributed according to the same disclaimer and license as libpng-0.96, with the following individuals added to the list of Contributing Authors: Tom Lane, Glenn Randers-Pehrson, Willem van Schaik. libpng versions 0.89, June 1996, through 0.96, May 1997, are Copyright (c) 1996, 1997 Andreas Dilger Distributed according to the same disclaimer and license as libpng-0.88, with the following individuals added to the list of Contributing Authors: John Bowler, Kevin Bracey, Sam Bushell, Magnus Holmgren, Greg Roelofs, Tom Tanner. libpng versions 0.5, May 1995, through 0.88, January 1996, are Copyright (c) 1995, 1996 Guy Eric Schalnat, Group 42, Inc. For the purposes of this copyright and license, "Contributing Authors" is defined as the following set of individuals: Andreas Dilger, Dave Martindale, Guy Eric Schalnat, Paul Schmidt, Tim Wegner. The PNG Reference Library is supplied "AS IS". The Contributing Authors and Group 42, Inc. disclaim all warranties, expressed or implied, including, without limitation, the warranties of merchantability and of fitness for any purpose. The Contributing Authors and Group 42, Inc. assume no liability for direct, indirect, incidental, special, exemplary, or consequential damages, which may result from the use of the PNG Reference Library, even if advised of the possibility of such damage. There is no warranty against interference with your enjoyment of the library or against infringement. There is no warranty that our efforts or the library will fulfill any of your particular purposes or needs. This library is provided with all faults, and the entire risk of satisfactory quality, performance, accuracy, and effort is with the user.

(j) openssl. Copyright (c) 1998-2005 The OpenSSL Project. All rights reserved. Redistribution and use in source and binary forms, with or without modification, are permitted provided that the following conditions are met: 1. Redistributions of source code must retain the above copyright notice, this list of conditions and the following disclaimer. 2. Redistributions in binary form must reproduce the above copyright notice, this list of conditions and the following disclaimer in the documentation and/or other materials provided with the distribution. 3. All advertising materials mentioning features or use of this software must display the following acknowledgment: "This product includes software developed by the OpenSSL Project for use in the OpenSSL Toolkit. (<http://www.openssl.org/>)" 4. The names "OpenSSL Toolkit" and "OpenSSL Project" must not be used to endorse or promote products derived from this software without prior written permission. For written permission, please contact openssl-core@openssl.org. 5. Products derived from this software may not be called "OpenSSL" nor may "OpenSSL" appear in their names without prior written permission of the OpenSSL Project. 6. Redistributions of any form whatsoever must retain the following acknowledgment: "This product includes software developed by the OpenSSL Project for use in the OpenSSL Toolkit (<http://www.openssl.org/>)" THIS SOFTWARE IS PROVIDED BY THE OPENSSL PROJECT "AS IS" AND ANY EXPRESSED OR IMPLIED WARRANTIES, INCLUDING, BUT NOT LIMITED TO, THE IMPLIED WARRANTIES OF MERCHANTABILITY AND FITNESS FOR A PARTICULAR PURPOSE ARE DISCLAIMED. IN NO EVENT SHALL THE OPENSSL PROJECT OR ITS CONTRIBUTORS BE LIABLE FOR ANY DIRECT, INDIRECT, INCIDENTAL, SPECIAL, EXEMPLARY, OR CONSEQUENTIAL DAMAGES (INCLUDING, BUT NOT LIMITED TO, PROCUREMENT OF SUBSTITUTE GOODS OR SERVICES; LOSS OF USE, DATA, OR PROFITS; OR BUSINESS INTERRUPTION) HOWEVER CAUSED AND ON ANY THEORY OF LIABILITY, WHETHER IN CONTRACT, STRICT LIABILITY, OR TORT (INCLUDING NEGLIGENCE OR OTHERWISE) ARISING IN ANY WAY OUT OF THE USE OF THIS SOFTWARE, EVEN IF ADVISED OF THE POSSIBILITY OF SUCH DAMAGE.

(j) SSLeay. Copyright (C) 1995-1998 Eric Young (ey@cryptsoft.com). All rights reserved. This package is an SSL implementation written by Eric Young (ey@cryptsoft.com). The implementation was written so as to conform with Netscapes SSL. This library is free for commercial and non-commercial use as long as the following conditions are adhered to. The following conditions apply to all code found in this distribution, be it the RC4, RSA, lhash, DES, etc., code; not just the SSL code. The SSL documentation included with this distribution is covered by the same copyright terms except that the holder is Tim Hudson (tjh@cryptsoft.com). Copyright remains Eric Young's, and as such any Copyright notices in the code are not to be removed. If this package is used in a product, Eric Young should be given attribution as the author of the parts of the library used. This can be in the form of a textual message at program startup or in documentation (online or textual) provided with the package. Redistribution and use in source and binary forms, with or without modification, are permitted provided that the following conditions are met: 1. Redistributions of source code must retain the copyright notice, this list of conditions and the following disclaimer. 2. Redistributions in binary form must reproduce the above copyright notice, this list of conditions and the following disclaimer in the documentation and/or other materials provided with the distribution. 3. All advertising materials mentioning features or use of this software must display the following acknowledgement: "This product includes cryptographic software written by Eric Young (ey@cryptsoft.com)" The word "cryptographic" can be left out if the routines from the library being used are not cryptographic related :-). 4. If you include any Windows specific code (or a derivative thereof) from the apps directory (application code) you must include an acknowledgement: "This product includes software written by Tim Hudson (tjh@cryptsoft.com)" THIS SOFTWARE IS PROVIDED BY ERIC YOUNG "AS IS" AND ANY EXPRESS OR IMPLIED WARRANTIES, INCLUDING, BUT NOT LIMITED TO, THE IMPLIED WARRANTIES OF MERCHANTABILITY AND FITNESS FOR A PARTICULAR PURPOSE ARE DISCLAIMED. IN NO EVENT SHALL THE

AUTHOR OR CONTRIBUTORS BE LIABLE FOR ANY DIRECT, INDIRECT, INCIDENTAL, SPECIAL, EXEMPLARY, OR CONSEQUENTIAL DAMAGES (INCLUDING, BUT NOT LIMITED TO, PROCUREMENT OF SUBSTITUTE GOODS OR SERVICES; LOSS OF USE, DATA, OR PROFITS; OR BUSINESS INTERRUPTION) HOWEVER CAUSED AND ON ANY THEORY OF LIABILITY, WHETHER IN CONTRACT, STRICT LIABILITY, OR TORT (INCLUDING NEGLIGENCE OR OTHERWISE) ARISING IN ANY WAY OUT OF THE USE OF THIS SOFTWARE, EVEN IF ADVISED OF THE POSSIBILITY OF SUCH DAMAGE. The licence and distribution terms for any publicly available version or derivative of this code cannot be changed. I.e. this code cannot simply be copied and put under another distribution license including the GNU Public License.

(k) pnet. Copyright (c) 2001-2005 Southern Storm Software, Pty Ltd. pnet is distributed under the GNU Lesser General Public License. A copy of the GNU Lesser General Public License may be found at <http://www.gnu.org/licenses/lgpl.html>. Portions of the work were modified by Zing Systems, Inc. 2005-2006. The original and modified source code can be found at www.sirius.com/opensource. THIS SOFTWARE IS PROVIDED BY THE AUTHOR(S) "AS IS" AND ANY EXPRESS OR IMPLIED WARRANTIES, INCLUDING, BUT NOT LIMITED TO, THE IMPLIED WARRANTIES OF MERCHANTABILITY AND FITNESS FOR A PARTICULAR PURPOSE ARE DISCLAIMED. IN NO EVENT SHALL THE AUTHOR(S) BE LIABLE FOR ANY DIRECT, INDIRECT, INCIDENTAL, SPECIAL, EXEMPLARY, OR CONSEQUENTIAL DAMAGES (INCLUDING, BUT NOT LIMITED TO, PROCUREMENT OF SUBSTITUTE GOODS OR SERVICES; LOSS OF USE, DATA, OR PROFITS; OR BUSINESS INTERRUPTION) HOWEVER CAUSED AND ON ANY THEORY OF LIABILITY, WHETHER IN CONTRACT, STRICT LIABILITY, OR TORT (INCLUDING NEGLIGENCE OR OTHERWISE) ARISING IN ANY WAY OUT OF THE USE OF THIS SOFTWARE, EVEN IF ADVISED OF THE POSSIBILITY OF SUCH DAMAGE.

(l) resample. Copyright 1994-2002 by Julius O. Smith III. Resample is distributed under the GNU Lesser General Public License. A copy of the GNU Lesser General Public License may be found at <http://www.gnu.org/licenses/lgpl.html>. Portions of the code (SNDLIB) are Copyright 2000 by Bill Schottstaedt. Portions of the work were modified by Zing Systems, Inc. 2005-2006. The original and modified source code can be found at www.sirius.com/opensource. THIS SOFTWARE IS PROVIDED BY THE AUTHOR(S) "AS IS" AND ANY EXPRESS OR IMPLIED WARRANTIES, INCLUDING, BUT NOT LIMITED TO, THE IMPLIED WARRANTIES OF MERCHANTABILITY AND FITNESS FOR A PARTICULAR PURPOSE ARE DISCLAIMED. IN NO EVENT SHALL THE AUTHOR(S) BE LIABLE FOR ANY DIRECT, INDIRECT, INCIDENTAL, SPECIAL, EXEMPLARY, OR CONSEQUENTIAL DAMAGES (INCLUDING, BUT NOT LIMITED TO, PROCUREMENT OF SUBSTITUTE GOODS OR SERVICES; LOSS OF USE, DATA, OR PROFITS; OR BUSINESS INTERRUPTION) HOWEVER CAUSED AND ON ANY THEORY OF LIABILITY, WHETHER IN CONTRACT, STRICT LIABILITY, OR TORT (INCLUDING NEGLIGENCE OR OTHERWISE) ARISING IN ANY WAY OUT OF THE USE OF THIS SOFTWARE, EVEN IF ADVISED OF THE POSSIBILITY OF SUCH DAMAGE.

(m) uClibc. Copyright (C) 2000-2002 Erik Andersen. UClibc is distributed under the GNU General Public License. A copy of the GNU General Public License may be found at <http://www.gnu.org/copyleft/gpl.html>. Portions of the work were modified by Zing Systems, Inc. 2005-2006. The original and modified source code can be found at www.sirius.com/opensource. THIS SOFTWARE IS PROVIDED BY THE AUTHOR(S) "AS IS" AND ANY EXPRESS OR IMPLIED WARRANTIES, INCLUDING, BUT NOT LIMITED TO, THE IMPLIED WARRANTIES OF MERCHANTABILITY AND FITNESS FOR A PARTICULAR PURPOSE ARE DISCLAIMED. IN NO EVENT SHALL THE AUTHOR(S) BE LIABLE FOR ANY DIRECT, INDIRECT, INCIDENTAL, SPECIAL, EXEMPLARY, OR CONSEQUENTIAL DAMAGES (INCLUDING, BUT NOT LIMITED TO, PROCUREMENT OF SUBSTITUTE GOODS OR SERVICES; LOSS OF USE, DATA, OR PROFITS; OR BUSINESS INTERRUPTION) HOWEVER CAUSED AND ON ANY THEORY OF LIABILITY, WHETHER IN CONTRACT, STRICT LIABILITY, OR TORT (INCLUDING NEGLIGENCE OR OTHERWISE) ARISING IN ANY WAY OUT OF THE USE OF THIS SOFTWARE, EVEN IF ADVISED OF THE POSSIBILITY OF SUCH DAMAGE.

(n) wpa_supplicant. Copyright (c) 2003-2006, Jouni Malinen <[jmalaine@cc.hut.fi](mailto:kmalaine@cc.hut.fi)> and contributors. THIS SOFTWARE IS PROVIDED BY THE COPYRIGHT HOLDERS AND CONTRIBUTORS "AS IS" AND ANY EXPRESS OR IMPLIED WARRANTIES, INCLUDING, BUT NOT LIMITED TO, THE IMPLIED WARRANTIES OF MERCHANTABILITY AND FITNESS FOR A PARTICULAR PURPOSE ARE DISCLAIMED. IN NO EVENT SHALL THE COPYRIGHT OWNER OR CONTRIBUTORS BE LIABLE FOR ANY DIRECT, INDIRECT, INCIDENTAL, SPECIAL, EXEMPLARY, OR CONSEQUENTIAL DAMAGES (INCLUDING, BUT NOT LIMITED TO, PROCUREMENT OF SUBSTITUTE GOODS OR SERVICES; LOSS OF USE, DATA, OR PROFITS; OR BUSINESS INTERRUPTION) HOWEVER CAUSED AND ON ANY THEORY OF LIABILITY, WHETHER IN CONTRACT, STRICT LIABILITY, OR TORT (INCLUDING NEGLIGENCE OR OTHERWISE) ARISING IN ANY WAY OUT OF THE USE OF THIS SOFTWARE, EVEN IF ADVISED OF THE POSSIBILITY OF SUCH DAMAGE.

(o) zlib. Zlib is copyright (C) 1995-2004 Jean-loup Gailly and Mark Adler.

(p) uisp. Copyright (C) 1999-2002 Uros Platise. uisp is distributed under the GNU General Public License. A copy of the GNU General Public License may be found at <http://www.gnu.org/copyleft/gpl.html>. Portions of the work were modified by Zing Systems, Inc. 2005-2006. The original and modified source code can be found at www.sirius.com/opensource. THIS SOFTWARE

IS PROVIDED BY THE AUTHOR(S) "AS IS" AND ANY EXPRESS OR IMPLIED WARRANTIES, INCLUDING, BUT NOT LIMITED TO, THE IMPLIED WARRANTIES OF MERCHANTABILITY AND FITNESS FOR A PARTICULAR PURPOSE ARE DISCLAIMED. IN NO EVENT SHALL THE AUTHOR(S) BE LIABLE FOR ANY DIRECT, INDIRECT, INCIDENTAL, SPECIAL, EXEMPLARY, OR CONSEQUENTIAL DAMAGES (INCLUDING, BUT NOT LIMITED TO, PROCUREMENT OF SUBSTITUTE GOODS OR SERVICES; LOSS OF USE, DATA, OR PROFITS; OR BUSINESS INTERRUPTION) HOWEVER CAUSED AND ON ANY THEORY OF LIABILITY, WHETHER IN CONTRACT, STRICT LIABILITY, OR TORT (INCLUDING NEGLIGENCE OR OTHERWISE) ARISING IN ANY WAY OUT OF THE USE OF THIS SOFTWARE, EVEN IF ADVISED OF THE POSSIBILITY OF SUCH DAMAGE.

(g) YAFFS. Copyright (C) 2002 Aleph One Ltd. . YAFFS is distributed under the GNU Lesser General Public License. A copy of the GNU Lesser General Public License may be found at <http://www.gnu.org/licenses/lgpl.html>. Portions of the work were modified by Zing Systems, Inc. 2005-2006. The original and modified source code can be found at www.sirius.com/opensource. THIS SOFTWARE IS PROVIDED BY THE AUTHOR(S) "AS IS" AND ANY EXPRESS OR IMPLIED WARRANTIES, INCLUDING, BUT NOT LIMITED TO, THE IMPLIED WARRANTIES OF MERCHANTABILITY AND FITNESS FOR A PARTICULAR PURPOSE ARE DISCLAIMED. IN NO EVENT SHALL THE AUTHOR(S) BE LIABLE FOR ANY DIRECT, INDIRECT, INCIDENTAL, SPECIAL, EXEMPLARY, OR CONSEQUENTIAL DAMAGES (INCLUDING, BUT NOT LIMITED TO, PROCUREMENT OF SUBSTITUTE GOODS OR SERVICES; LOSS OF USE, DATA, OR PROFITS; OR BUSINESS INTERRUPTION) HOWEVER CAUSED AND ON ANY THEORY OF LIABILITY, WHETHER IN CONTRACT, STRICT LIABILITY, OR TORT (INCLUDING NEGLIGENCE OR OTHERWISE) ARISING IN ANY WAY OUT OF THE USE OF THIS SOFTWARE, EVEN IF ADVISED OF THE POSSIBILITY OF SUCH DAMAGE.

(f) rload. Copyright (C) 2002 RidgeRun, Inc. rload is distributed under the GNU General Public License. A copy of the GNU General Public License may be found at <http://www.gnu.org/copyleft/gpl.html>. Portions of the work were modified by Zing Systems, Inc. 2005-2006. The original and modified source code can be found at www.sirius.com/opensource. THIS SOFTWARE IS PROVIDED BY THE AUTHOR(S) "AS IS" AND ANY EXPRESS OR IMPLIED WARRANTIES, INCLUDING, BUT NOT LIMITED TO, THE IMPLIED WARRANTIES OF MERCHANTABILITY AND FITNESS FOR A PARTICULAR PURPOSE ARE DISCLAIMED. IN NO EVENT SHALL THE AUTHOR(S) BE LIABLE FOR ANY DIRECT, INDIRECT, INCIDENTAL, SPECIAL, EXEMPLARY, OR CONSEQUENTIAL DAMAGES (INCLUDING, BUT NOT LIMITED TO, PROCUREMENT OF SUBSTITUTE GOODS OR SERVICES; LOSS OF USE, DATA, OR PROFITS; OR BUSINESS INTERRUPTION) HOWEVER CAUSED AND ON ANY THEORY OF LIABILITY, WHETHER IN CONTRACT, STRICT LIABILITY, OR TORT (INCLUDING NEGLIGENCE OR OTHERWISE) ARISING IN ANY WAY OUT OF THE USE OF THIS SOFTWARE, EVEN IF ADVISED OF THE POSSIBILITY OF SUCH DAMAGE.

Copyrights & Trademarks

Copyrighted Broadcast Material

Several features of the Stiletto 10 enable you to record and store broadcast content for playback. Broadcast content is subject to copyright laws, and distribution of copyrighted material is prohibited by law without the express permission of the copyright holder. To prevent unlawful distribution of copyrighted material, the Stiletto 10 prevents you from electronically copying stored (recorded) songs or shows to another device.

Copyrights & Trademarks

© 2006 Sirius Satellite Radio Inc. All Rights Reserved.

® "SIRIUS" and related marks, the SIRIUS dog logo, channel names and logos are registered trademarks of Sirius Satellite Radio Inc. "NFL" and the NFL Shield logo, and the NFL Sunday Drive name and logo are registered trademarks of the National Football League. "NHL" and the NHL Shield are registered trademarks of the National Hockey League. "NBA" and the NBA silhouette logo are registered trademarks of NBA Properties Inc. Microsoft, Windows, and Windows Media are registered trademarks of Microsoft Corporation. All other trademarks, service marks, sports team names, album art, and logos are the property of their respective owners. All Rights Reserved.

™ My Sirius Studio and Stiletto Series are trademarks of Sirius Satellite Radio Inc.

MPEG Layer-3 audio coding technology licensed from Fraunhofer IIS and Thomson.

Hardware, subscription, and activation fee required. For full Terms & Conditions, visit <http://sirius.com>. Prices and programming are subject to change. Not available in HI and AK. Equipment and subscription sold separately. Installation required with some equipment.

SIRIUS ID

Write down the SIRIUS ID (SID) of your Stiletto 10 in the space provided below.

SID: _____

Index

A

- Activating the Stiletto 10 25
- Antenna
 - Antenna Aiming 24, 56
- Audio *See* Sounds and Volume

B

- Back Button 15
 - Use of. 23
- Battery
 - Average Listening Time 10
 - Battery Disposal 12
 - Battery Life when Stiletto is Off 21
 - Charging 12
 - Increasing Time Between Charges 10
 - Installation and Removal 11

- Brightness, Display 55

Broadcasts

- Fast Forwarding and Rewinding 34
- Pausing 33
- Playing 33

Browsing and Navigating Channels

- Satellite Radio 30

C

- Channel Presets 31
 - Removing 32
 - Saving 32
 - Tuning 31
- Cleaning the Stiletto 6
- Computer, Connecting to 26
- Copyrighted Broadcast Material 86
- Copyrights and Trademarks 86

D

- Deleting Content. 43
- Device Information. 56
- Display Button 15
 - Use of. 30
- Display Screen
 - Backlight Timer 55
 - Brightness 55

E

- End User License Agreement 78

F

- Fast Forward Function 14
 - Selecting 20
- FM Transmitter, Turning On/Off 57

G

- Game Alert. 36
 - See also* Sports
- General Precautions. 5

H

- Hiding/Showing Channels and
 - Genres 38, 55
- Home Button. 15
 - Use of. 22, 23
- Home Screen 22

I

- IC Caution 4

L

- Legal Information 56
- Library 27, 40
 - Browsing and Navigating 42, 43
 - Checking Memory Usage 56

Deleting Content	43
Now Playing Screen	41
Storage Limits	45
Liquid Crystal Precautions.	5
Locked Channels	38
<i>See also</i> Parental Controls	
Locking/Unlocking	58
Lock Switch <i>See</i> Power/Lock Switch	
M	
Media Dial	15
Use of	16, 20, 23
Memory	
Checking Usage	56
Storage Limits	45
My Sirius Studio Software	6, 26
Installation	71
N	
Navigating	
Channels, Satellite Radio	30
Library	42, 43
Menus and Lists	22
Radio Replays	48
Now Playing Screen	
Library	41
Radio Replays	47
Satellite Radio	29
O	
Operating Temperature	6
Optional Accessories	
Executive Sound System	75
Home Kit	9, 74
Vehicle Kit	9, 74
Options Button	15
P	
Package Contents	7
Parental Controls	38

<i>See also</i> Locked Channels	
Turning On/Off	58
Play/Pause Function	14
Selecting	20
Power/Lock Switch	14
Locking the Stiletto.	21
Powering the Stiletto Off	21
Sleep Mode.	21
Presets, Channel. <i>See</i> Channel Presets	
R	
Radio Replays	27, 46
Navigating	48
Now Playing Screen	47
Turning Feature On/Off.	58
Record Function	15, 34
Selecting	20
Recording	27, 50
Editing	53
Scheduling	51
Reference Guide	
Buttons, Controls, Connectors	13
Reset and Erase	57
Rewind Function.	14
Selecting	20
S	
Safety Precautions.	5
Satellite Radio	27, 28
Browsing and Navigating Channels	30
Now Playing Screen	29
Saving Content	
Scheduling a Recording	51
Scheduled Recording <i>See</i> Recording	
Seek Alert	
Library	
Artist and Song Seek Alert	44
Maintaining Artist and Song Seek Lists 54	

Radio Replays	
Artist and Song Seek Alert	49
Satellite Radio	
Artist and Song Seek Alert	39
Select Button	15
Use of.	20
Settings	54
Artist & Song Seek	54
Artist Seek List	54
Seek Alerts	54
Song Seek List	54
Audio & Display.	55
Backlight Timer	55
Brightness	55
Say Chan Name	55
System Sounds	55
System Volume	55
Channels	55
Hidden Channels.	55
Hidden Genres	55
Device	55
Antenna Aiming	56
Device Info	56
Legal Info.	56
Memory Usage.	56
Reset and Erase	57
Sirius ID	55
Time Zone	56
Dock	57
FM Transmit.	57
Parental Controls	58
Locked Channels.	58
Parental Controls.	58
Radio Replays	58
Settings Description	27, 54
Sports	58

Favorite Teams.	58
Game Alerts.	58
Sports Ticker	58
Sirius ID	55, 87
Sleep Mode	21
Sounds	
Spoken Channel Names	55
System Sounds.	55
Specifications	76
Sports	
Game Alert Feature.	36
Adding/Removing Teams	58
Turning On/Off.	58
Game Zone Category.	37
Sports Ticker Feature.	37
Turning On/Off.	58
Subscribing to the SIRIUS Service	25
T	
Table of Contents	2
Time Zone, Setting.	56
Troubleshooting	72
U	
USB Connection.	26
V	
Volume	
System Volume	55
Volume Control.	14
Volume and Hearing Safety Precautions.	5
W	
Warning and Safety Information	4
Warranty.	77



RADIO YOUR WAY™

SIRIUS Customer Service: 1-888-539-7474

customercare@siriuscanada.ca

SIRIUS Canada Inc.

135 Liberty Street, 4th Floor

Toronto, Ontario M6K 1A7

1-888-539-7474

www.siriuscanada.ca

SIRIUS Satellite Radio Inc.

135 Liberty Street, 4th Floor

Toronto, Ontario M6K 1A7

1-888-539-7474

www.siriuscanada.ca



RADIO YOUR WAY™