



User Guide

**Stratus 7
Radio & Vehicle Kit**

Table of Contents

Introduction	4	Jump Settings	43
Safety and Care Information	5	Display	44
What's in the Box?	7	Audio Level	46
Stratus 7 Functions	8	Signal	47
Home Dock Color-Coded Connections	9	Factory Default	48
Remote Control Battery Replacement	10	Troubleshooting	49
Home Installation	11	Product Specifications	51
Step 1: Connect the Home Dock	11	Patent Information	52
Step 2: Install the Indoor/Outdoor Antenna	16	IC Statement	53
Subscribe	21	Copyrights and Trademarks	54
Using Your Stratus 7	23	Owners Record	55
The Main Display	23	Indoor/Outdoor Antenna Template	56
My Channels	24		
Navigation Basics	25		
Listening to Satellite Radio	27		
FM Presets	31		
Special Features	32		
Parental Lock	32		
Where Else Can You Use Your Stratus 7?	35		
Configuring Your Stratus 7	36		
Sirius ID	36		
Find Available FM Channels in Your Area	37		
Turn FM Transmitter On/Off	40		
Set and Select an FM Channel	41		

Introduction

Thank you for purchasing the Stratus 6 with Home Kit!

Stratus 7 has these exciting features to enhance your overall experience:

- Add SiriusXM to a home audio system or powered speakers with easy, do-it-yourself set-up.
- Use the remote control to conveniently operate your Radio from across the room.
- View artist name, song title, and channel information on the easy-to-read display.
- Store your favourite channels for one touch access.
- Easily lock and unlock channels with mature content.
- One-Touch Jump™: Directly access traffic and weather of the 20 most congested cities.
- Home kit included — add accessories to listen in a vehicle, office, or on the go.

Use this manual to familiarize yourself with all of your Stratus 7's features and capabilities. For the latest information about your Stratus 7 and other products and accessories, visit **siriusxm.ca**.

Introduction

Safety and Care Information



IMPORTANT! Self installation instructions and tips are provided for your convenience. It is your responsibility to determine if you have the knowledge, skills, and physical ability required to properly perform an installation. SiriusXM shall have no liability for damage or injury resulting from the installation or use of any SiriusXM or third party products. It is your responsibility to ensure that all products are installed in adherence with local laws and regulations and in such a manner as to allow a vehicle to be operated safely and without distraction. SiriusXM product warranties do not cover the installation, removal or reinstallation of any product.

- Do not expose to extreme temperatures (above 140° F or below -4° F, or above 60° C or below -20° C).
- Do not expose to moisture. Do not use device near or in water. Do not touch the device with wet hands.
- Do not let any foreign matter spill into device.
- Do not store in dusty areas.
- Do not expose to chemicals such as benzene and thinners. Do not use liquid or aerosol cleaners. Clean with a soft damp cloth only.
- Do not expose to direct sunlight for a prolonged period of time, and do not expose to fire, flame, or other heat sources.
- Do not try to disassemble and/or repair device yourself.
- Do not drop your device or subject it to severe impact.
- Do not place heavy objects on device.
- Do not subject device to excessive pressure.
- If the LCD screen is damaged, do not touch the liquid crystal fluid.

Introduction

Warning!

- Opening the case may result in electric shock.
- If the liquid crystal fluid comes in contact with your skin, wipe the skin area with a cloth and then wash the skin thoroughly with soap and running water. If the liquid crystal fluid comes into contact with your eyes, flush the eyes with clean water for at least 15 minutes and seek medical care. If the liquid crystal fluid is ingested, flush your mouth thoroughly with water. Drink large quantities of water, and induce vomiting. Seek medical care.
- Make sure that you insert the Home Power Adapter's plug all the way into the outlet.

Introduction

What's in the Box?

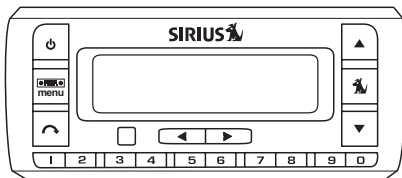

Stratus 7 Radio

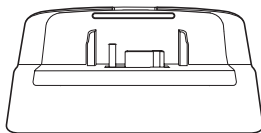

Home Dock

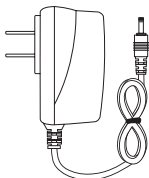

AC Adapter



Audio Cable



Indoor/Outdoor
Home Antenna

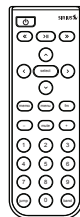

Remote
Control

Unpack your Stratus 6 radio carefully and make sure that everything shown is present. If anything is missing or damaged, or if your the radio fails to operate, notify your dealer immediately. We recommend that you retain the original carton and packing materials in case you need to ship your radio in the future.

Introduction

Stratus 7 Functions

Power Button

Press to turn Stratus 7 on and off.

FM / Menu Button

FM: Press to access and cycle through FM presets.

Menu: Press and hold to access advanced features and configuration options; in configuration options, press and hold to return to main display screen.

Up and Down Buttons

Press to preview and tune channels through the channel lineup; also press to scroll through lists and highlight menu items.

Select Button

Press to confirm selection of highlighted items in a menu or list; when not in a menu or list, press first before entering the channel number, to directly tune to a channel. Press and hold to go back to the previous channel.

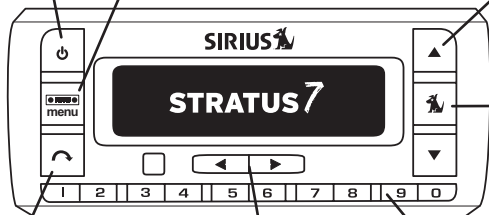

Jump Button

Access traffic and weather of the 20 most congested cities.

Left and Right Arrows

Press to search for channels by category.

Number Buttons

Press to tune to a stored favorite channel, press and hold to store a favourite channel; also enter a channel number.

Introduction

Home Dock Color-Coded Connections

The color-coded Home Dock makes it simple to connect the cables to the appropriate connectors at the rear of the dock.

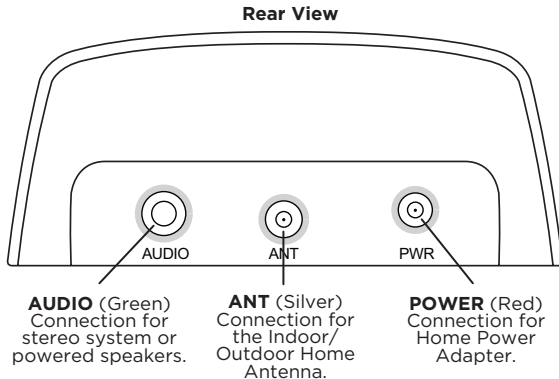

Introduction

Remote Control Battery Replacement

The Remote Control has a child safe battery compartment which requires a pointed object to open the battery compartment. A paper clip is recommended, as shown.

To Replace the Battery:

- 1.** Press the paper clip or other object into the lock release opening on the Remote Control, and slide the battery compartment cover off of the Remote Control.
- 2.** Slide the battery out of the battery compartment.
- 3.** Replace with a new battery. Observe the correct orientation of the battery; the + positive side of the battery should be facing up.
- 4.** Replace the battery compartment cover.

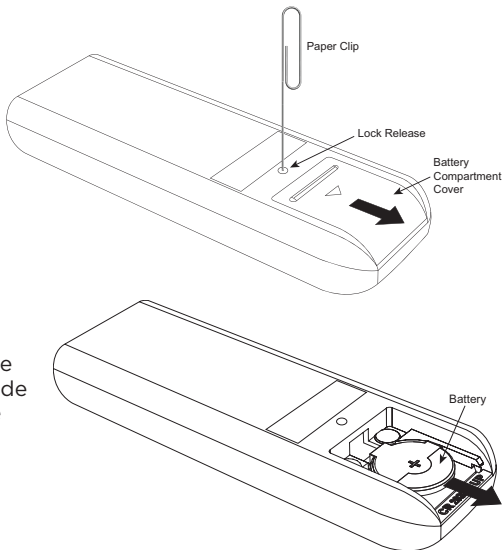

Home Installation

There are two parts to setting up your Home Kit. First, connecting the Home Dock to your stereo or powered speakers, then placing and aiming the Home Antenna. Let's start with getting your Home Dock set up.

Step 1: Connect the Home Dock

When installing the Home Dock in your home, choose a location in close proximity to your home stereo system or powered speakers, and also where the cable from the Indoor/Outdoor Antenna can reach the Home Dock. The location should be easily accessible and provide good visibility of the display, but should not be located where it will be in direct sunlight, which will affect the visibility of the display screen.

You will also need to decide whether you will be connecting your Home Dock to your home stereo system using the provided Stereo Audio Cable, or directly to powered speakers.

Connect the Indoor/Outdoor Antenna

Once you have selected a location, connect the antenna to the **ANT** connector at the rear of the Home Dock. (After completing a few additional steps, we will work on the location of the antenna.)

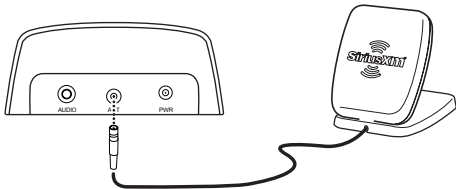

Home Installation

Connect the Home Power Adapter

Connect the Home Power Adapter to the **PWR** connector at the rear of the Home Dock, and plug it into a wall outlet.

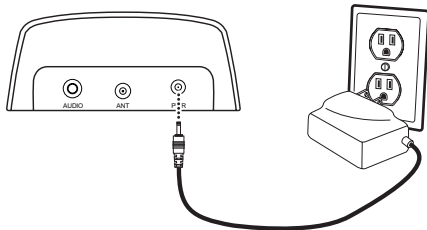

Connect the Home Dock to a Home Stereo System or Powered Speakers

The Home Dock can be connected to your home stereo system, or to a pair of powered speakers. If you are connecting to a home stereo system, see the following section. If you are connecting to a pair of powered speakers, see “To Connect the Home Dock to Your Powered Speakers” on page 14.

Home Installation

To Connect the Home Dock to Your Home Stereo System

The Home Dock can be connected to your home stereo system through the AUX IN or LINE IN connection of your home stereo system, using the provided Stereo Audio Cable.

- 1.** Take the provided Stereo Audio Cable and connect the single 3.5 mm (1/8") connector to the **AUDIO** connector at the rear of the Home Dock.
- 2.** Connect the white left and red right Stereo Audio Cable connectors ("L" and "R" are also on each respective tip) to any available input other than PHONO on your home stereo system. (If your stereo's inputs are marked red and black, simply connect the white plug to the black input.)

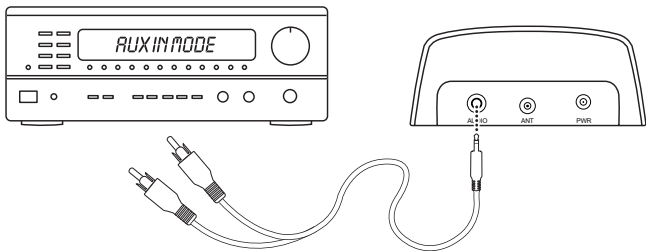

- 3.** Turn the home stereo system On, and make sure you select the correct input on your stereo system for the **AUX In** or **LINE In** connection.

Home Installation

To Connect the Home Dock to Your Powered Speakers

The Home Dock can be connected directly to a pair of powered speakers.

1. Connect the 3.5 mm (1/8") connector from the powered speakers to the **AUDIO OUT** connector at the rear of the Home Dock.
2. Plug the powered speakers into an AC outlet.

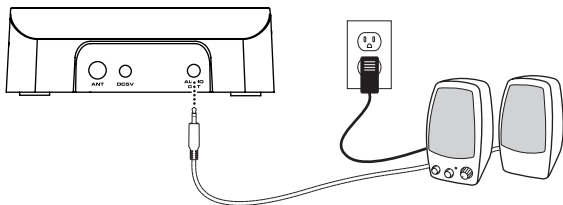

3. Turn On the powered speakers.

Home Installation

Dock Your Radio

Place the radio into the Home Dock, aligning the connector on the Stratus 6 with the connector on the Home Dock, and gently press the Radio down until it is fully seated in the Home Dock. Press the power button on the radio to turn it on.

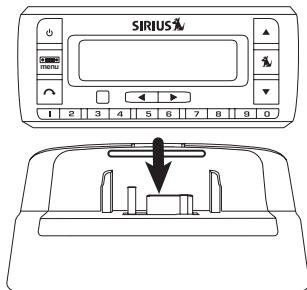

Home Installation

Step 2: Install the Indoor/Outdoor Antenna

To begin, try experimenting with the Home Antenna to get a feel for the reception in your location. Move the antenna around the room or from room to room. Aim it from different windows. In major metropolitan areas, you might find that you get great reception in several locations without worrying too much about aim and placement.

Refer to your radio's User Guide for instructions, and access the **Signal** or **Signal Indicator** screen of your radio to see a visual indication of signal strength. If you're receiving a good Satellite and Terrestrial signal strength, you're done. If not, try some of the suggestions which follow.

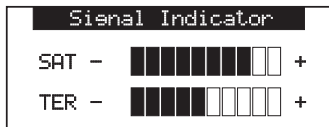

Other Indoor/Outdoor Antenna Installation Suggestions

If you find you are getting a signal, but it's inconsistent, try moving the Indoor/Outdoor Antenna closer to a window, ideally one that is facing due south.

Not sure which way is south? Think about where the sun rises (in the east) and sets (in the west). Then stand so that east is to your left and you'll be facing south. Is there a window in the direction

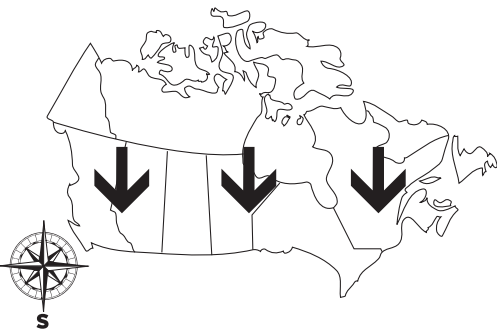

Home Installation

you're facing? Move the antenna closer to the window.



TIP! Still not sure which way is south or where to place your Home Antenna? Look up your location on an online mapping Web site that offers satellite views of street addresses where you can easily see which way is south, and what window may offer an unobstructed view of the sky.

Another easy method is to start at any window, then work from window to window in a simple pattern to find the window gives the best signal strength. Note that the antenna must also have an unobstructed view. No trees or buildings blocking its aim. If the antenna is aimed through a window, be aware that blinds, screens, or any other non-glass elements such as thermal insulation can sometimes cause reception issues. If this is the case, you may want to use another window or place the antenna outside of the window.

If you find a window that gives you good signal strength, you can place the antenna on the windowsill. The antenna may need to be placed on something to raise it above the level of the window frame.

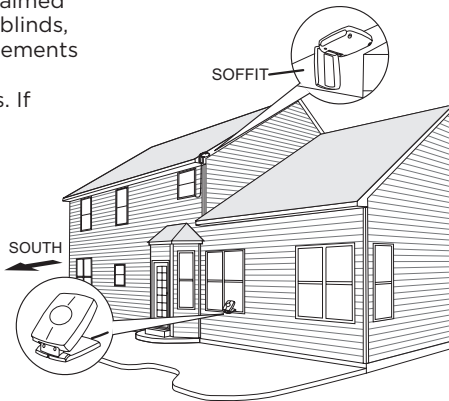
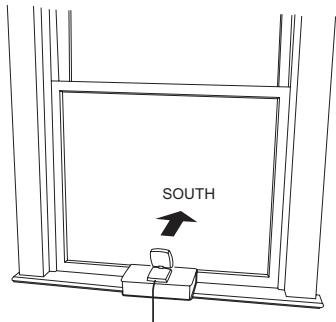

Home Installation

If you don't have a window where you receive a consistent signal, or placing the antenna in a window is not a practical solution for you, **BETTER** reception can be achieved by placing the antenna outside on a window ledge, porch, table, or patio. The location you choose should provide the antenna with a clear view of the southern sky.

If none of the previous solutions work for you, then the **BEST** reception can be achieved by mounting the antenna outdoors, with a clear view of the southern sky.

Note that you will want to consider any potential hazards when you choose the mounting location, and possibly consider professional installation. XM Radio Inc. is not liable for any damages.

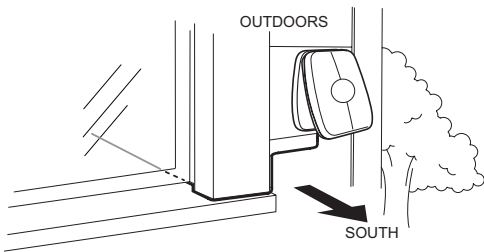

To mount the antenna, you will need four screws (not included) with a 1/4" head (e.g., an M3 screw), and that are suitable for the material onto which you are affixing the antenna, (e.g., wood, metal, etc.). The screws should be spaced 30 mm (1-3/8") apart horizontally and 36.5 mm (1-1/8") vertically. Refer to the template on "Indoor/Outdoor Antenna Template" on page 56.

Once you have found a suitable location for the antenna, route the antenna cable to the Home Dock. Be sure you avoid any obstructions that could crimp, kink, or twist the cable. Use protective grommets wherever rough openings are encountered. If the antenna is installed outdoors, route

Home Installation

the cable from the antenna location to the interior of the home, working the cable through the basement, under a window sill, etc., and make adjustments to take up cable slack as necessary.



TIP! If your Indoor/Outdoor Antenna's cable isn't long enough, visit siriusxm.ca, or your favourite retailer, and consider a 15 m (50 ft.) Indoor/Outdoor Antenna Extension Cable or a Wireless Home Signal Repeater.

If the signal is good for either Satellite or Terrestrial (or both), and you are hearing the audio from the radio, the installation is complete.

If the signal reception is low, or intermittent, try another location for the antenna. Verify that the antenna is pointed south, and that the antenna's view of the sky is not blocked by a tree, a building, a bridge, or anything else. Adjust until you are receiving a good signal.

The Indoor/Outdoor Antenna's reception can also be tweaked by opening or closing the antenna clamshell, and turning the antenna. While observing the signal strength, make small adjustments to the angle of tilt of the clamshell until the highest possible signal strength is achieved. If you have not wall-mounted the antenna, turn the antenna slightly to the right or left and observe if the signal strength increases. For each tweak, allow a few seconds in each position to determine if the signal strength increases.

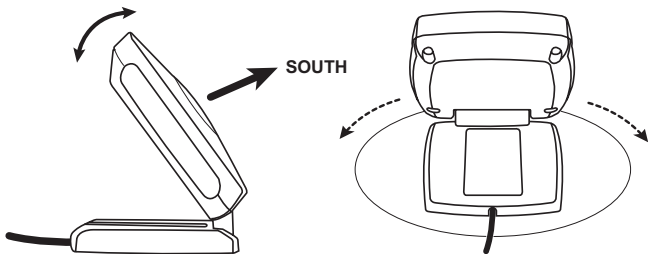

Home Installation

If the signal reception is good, but there is no audio, verify your audio connection.

- If you are connected to a home stereo system, be sure the system is set to the auxiliary input source, and you have connected the Stereo Audio Cable to the auxiliary input connectors.
- If you are connected to powered speakers, be sure the speakers are plugged into an outlet, and are turned On.

The audio level of your radio can also be increased. Refer to the User Guide which accompanied your radio and increase the audio level.

If you still have questions, for example, 'Are there any other options/things I should consider?', etc., refer to "Troubleshooting" on page 49.

Subscribe

Before you can enjoy Commercial-Free Music, plus Sports, News, Talk & Entertainment, you need to activate your Stratus 7:

1. Make sure your Stratus 7 is turned on, tuned to Sirius Preview channel 184, and receiving the Sirius signal so that you can hear the Sirius audio.
2. When you first turn on Stratus 7, after the startup sequence, the Sirius channel lineup may update. Wait until any channel updates have completed before pressing any buttons. Once the channels have been updated, the Radio will automatically tune to channel 184.
3. Make a note of the Sirius ID. You can find it:
 - by selecting **Sirius ID** in menu items
 - on channel 0 (zero)
 - on a label on the bottom of the gift box
 - on the label on the back of your Stratus 7
4. To subscribe:
 - Online: Go to siriusxm.ca/activate to access or set up an online account, subscribe to the service, and activate your Radio.
 - OR
 - By phone: Call **1-888-539-7474**.

Activation usually takes less than 5 minutes, but sometimes may take longer. We recommend that your Radio remain on

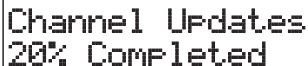

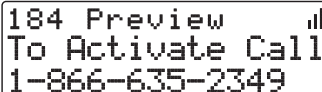

Channel Updates
20% Completed

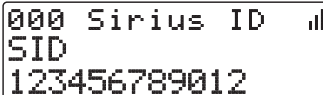

184 Preview 
To Activate Call
1-866-635-2349

*The phone number shown above may differ from the one shown on your Stratus 6. All numbers are valid.



000 Sirius ID 
SID
123456789012



184 Preview 
Sub Updated
Press Any Key

Subscribe

until activated. When your service is activated, your Stratus 7 will display an alert message. To continue, press any button. Once subscribed, Stratus 7 will receive and you can tune to channels in your subscription plan.

Press ▲ or ▼ to tune to other channels, and ◀ or ▶ to browse the different categories of channels. Learn what all the buttons do by turning to “Navigation Basics” on page 25.

Using Your Stratus 7

The Main Display

Whenever you power your Stratus 7 On, it will automatically tune to the last channel you were listening to before it was powered Off. Stratus 7's display screen will show the channel number, the song or show being played, and the artist name of the current channel. This screen is referred to as the main display screen in this guide.

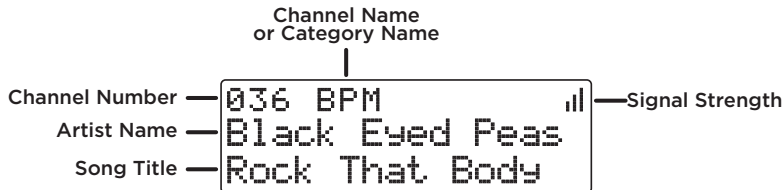

You can also choose to have either the channel name or category name displayed on the main display screen. To pick the mode, press and hold the **menu** button, press the ▼ button to highlight **Display** and press the **Select** button. Press the ▼ button to highlight **Mode** and press the **Select** button. Then choose the desired option. (Refer to “Display” on page 44.)

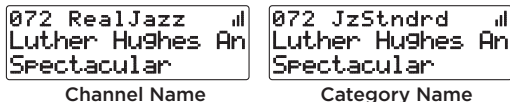

Using Your Stratus 7

My Channels

Channels are organized into categories to make it easier for you to find the ones that suit your taste. My Channels is a special category that displays the channels contained in your subscription plan. You can display this and any category by pressing ◀ or ▶ until the category is displayed.

Category Name

My Channels(151)

Channel Names

>001 Hits 1
002 TheBlend

Total Channels in
Your Subscription
Plan

Using Your Stratus 7

Navigation Basics

Power Button

Pressing the **Power button** turns Stratus 7 On or Off.



Navigation Buttons

Use the **Left**, **Right**, **Up**, and **Down** buttons to navigate through various features and functions of Stratus 7.



- **Left ◀ or Right ▶ button:** Displays the channel categories such as Rock, Pop, Sports, Talk/New etc. Repeated presses cycle through the categories one at a time. Decreases or increases the settings of various menu options such as Brightness, Audio Level, etc.
- **Up ▲ or Down ▼ button (press and release):** Immediately tunes to the next or previous channel in the channel lineup. Scrolls through lists and highlights an item in the list.
- **Up ▲ or Down ▼ button (press and hold):** Continuously scrolls through any list. While on the main display screen, continuously scrolls through the channel lineup and briefly displays the information of each channel. When the button is released, the Radio tunes to the last channel it had scrolled to in the channel lineup.

Select Button



The **Select button** selects a highlighted item and confirms settings. At the main display screen, pressing the **Select button** prompts for the entry of a channel number using the number buttons. Once the channel number is entered, the Radio directly tunes to the new channel. At the main display

Using Your Stratus 7

screen, pressing and holding the **Select button** tunes to the previous channel that was being played.

FM/Menu Button



FM provides easy tuning of FM presets for optimized *PowerConnect* performance. Repeatedly pressing **FM** displays and cycles through the list of preset FM channels one at a time. The Radio automatically tunes to the displayed FM channel.

Pressing and holding **menu** displays various options to make setup and feature changes. Pressing **menu** when in menu options returns to the previous menu option screen until menu options is exited. Pressing and holding **menu** when in menu options returns to the main display screen.

Jump Button



When configured properly, pressing **jump** tunes to the channel broadcasting traffic and weather conditions of a selected city, from a list of the 20 most congested cities.

Number Buttons



Each number button stores a favorite channel in its button location and provides one touch access to it afterward. Number buttons also directly tune to a channel when the channel number is entered after pressing the **Select button**.

Using Your Stratus 7

Listening to Satellite Radio

Tune a channel:

1. Press and release ▲ and ▼ to immediately tune to the next or previous channel.
2. Press and hold ▲ and ▼ to speed scroll through the channels. Release to tune to channel which is displayed.

View a category:

Channels are organized into categories to make it easier for you to find the ones that suit your taste.

1. To view a category press ◀ or ▶.
2. Scroll through the channels in the category using ▲ and ▼, and find the channel you want.
3. Press the **Select button** to select the channel, or press ◀ or ▶ for the previous or next category.

```
Pop  
>001 Hits 1  
002 TheBlend
```

```
Rock  
>014 ClsVinyl  
015 ClsRewnd
```

```
Dance/Electronic  
>035 Chill  
036 BPM
```

Using Your Stratus 7

Direct Tune

A channel can be tuned directly by entering the channel number using the number buttons.

1. To directly tune a channel press the **Select button**.





2. Enter the channel number using the buttons **0-9**. Wait a moment until the channel is tuned, or press the **Select button** to immediately tune to the channel.

Using Your Stratus 7

Jump

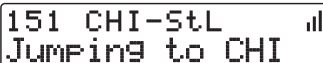
When configured properly, pressing **jump** will tune to the traffic and weather channel of a selected city, from a list of the 20 most congested cities. This button allows you to quickly tune the traffic/weather broadcast of the selected city, and then tune back to the original channel to which you were listening by pressing **jump** again.



151 CHI-StL 
Jumping to CHI

If the traffic/weather broadcast of your selected city is not immediately available, the display will indicate that a jump is pending. Once the traffic/weather report is ready to be broadcast, the Radio will automatically tune to the traffic/weather channel. Since a channel may carry the traffic and weather reports of more than one city, you may have to wait a few minutes for your desired broadcast.



053 SoulTown 
CHI Pending

Pressing the **jump** while a jump is pending will cancel the jump. Pressing **jump** after the Radio has tuned to the traffic/weather channel will return it back to the channel you to which you had been listening immediately prior to pressing **jump**.



TIP! To select a city for traffic/weather, refer to “Jump Settings” on page 43.

Using Your Stratus 7

Returning to main display screen

When changing the Radio options using the menu options, pressing and holding **menu** in most instances will return you to the main display screen. In some instances, you may need to follow the instructions on the display screen.

Favorite Channels

You can set up to 10 of your favorite channels so you can easily access them. Each favorite channel can be assigned to a number button (**0-9**).

To assign a favorite channel to a number button:

1. Tune to the desired channel.
2. Press and hold a number button (**0-9**) for one second, to assign the channel as a favorite.

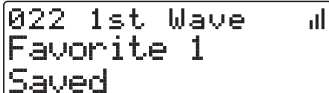

022 1st Wave 
Favorite 1
Saved

To listen to a favorite channel:

1. Press the number button **0-9** that was assigned to the desired favorite channel.

Using Your Stratus 7

FM Presets

FM presets make it easy to quickly access stored FM channels and choose a new FM channel from them.

Use FM presets when you use *PowerConnect* to listen to your Stratus 7 through your vehicle's FM radio.

To start using a different FM preset:

- 1.** Press **FM** to display the current FM channel preset.
- 2.** The currently selected FM preset is shown. To display and select the next FM preset press **FM**.
- 3.** Repeatedly pressing **FM** will cycle through the FM presets. The last displayed FM preset will be tuned. To return to the main display screen, allow the screen to time out.

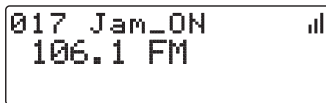

IMPORTANT! You need to ensure that the FM Transmitter in Stratus 7 is turned On, and that your vehicle's FM radio is tuned to the same FM channel.



TIP! To configure the list of preset FM channels, you need to find available FM channels in your area. Refer to "Find Available FM Channels in Your Area" on page 37. Next, refer to "Set and Select an FM Channel" on page 41.

Special Features

Parental Lock

Your Stratus 7 has the ability to lock channels you do not want others (such as children) to access without your permission. Locked channels will not appear in the channel or category list. The default lock code is 0000.

Locked channels can be tuned directly using the 0-9 number buttons and entering the locked channel number. You will be prompted to enter your lock code. If the lock code is correctly entered, the channel will begin playing. If you tune away from the locked channel to a different channel, the locked channel will again be locked.

Changing the lock code:

1. Press and hold **menu** until the menu options are displayed.
2. Press ▼ to scroll to and highlight **Parental Lock** and press the **Select button**.
3. Press ▼ to scroll to and highlight **Change My Code** and press the **Select button**.
4. You will be prompted to enter the existing lock code. The default lock code is 0000. If this is the first time you are changing the lock code, enter **0000**, otherwise enter your lock code. Use the **0-9** number buttons to enter the code and press the **Select button**.
5. Enter a new 4 digit code using the **0-9** number buttons.

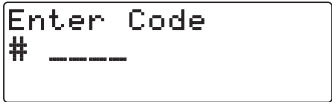

```
Enter Code  
# ____
```



```
New Code  
# ____
```



Special Features

- Once you have entered the code you will then be prompted to enter the new code again to confirm. If you entered the same lock code again, the code is saved.
- Press and hold **menu** to exit.

```
Confirm Code  
# ----
```

```
Confirm Code  
Code Saved
```

To lock or unlock a channel:

- Press and hold **menu** until the menu options are displayed.
- Press ▼ to scroll to and highlight **Parental Lock** and press the **Select button**.
- Lock/Unlock** is highlighted. Press the **Select button**.
- You will be prompted to enter your 4 digit lock code. Enter the lock code using the **0-9** number buttons.
- When you have entered the correct code, a list of channels will be displayed. Press ▼ and ▲ to scroll through the list and highlight a channel you want to lock or unlock.
- Press the **Select button** to lock or unlock a channel. Note that locked channels will display a lock icon  to

```
Parental Lock  
>Lock/Unlock  
Change My Code
```

```
Enter Code  
# ----
```

```
Lock/Unlock  
>104 Raw Dog   
105 LaughUSA
```

Special Features

the right of the channel name.

7. You can continue to select channels for locking or unlocking. When you are finished, press and hold **menu** to exit.

Where Else Can You Use Your Stratus 7?

SiriusXM offers a variety of accessories that allow you to adapt your Stratus 7 Radio to your lifestyle and enhance your listening experience. With these accessories, you can effortlessly take your Satellite Radio listening experience from your vehicle to your home or office or on the go — all with a single subscription.

- In the Home, Office, etc. – With a Home Kit, you can play your Stratus 7 over an existing home, office, or other stereo system.
- In Other Vehicles – With a Vehicle Kit, you can enjoy your Stratus 7 in more than one vehicle.
- In Almost Any Location You Like – With a desktop or portable Sound System you have the freedom to listen to your Stratus 7 where and when you want, from your kitchen or den, to the office, to outside on the deck, or at a picnic.

For more information on Sirius accessories or to purchase an accessory, please visit your local retailer or shop.siriusxm.ca.

Configuring Your Stratus 7

Sirius ID

Your Stratus 7 has a numeric 12-digit ID which uniquely identifies the Radio. This ID is used during the activation process.

To display the Sirius ID:

1. Press and hold **menu** until the menu options are displayed.
2. **Sirius ID** will be highlighted. Press the **Select button**. The Radio ID will be displayed.
3. Press and hold **menu** to exit.

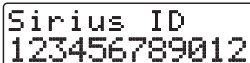
A rectangular box containing a monospaced font display of the text "Sirius ID" on the first line and the numeric ID "123456789012" on the second line.

```
Sirius ID
123456789012
```

Configuring Your Stratus 7

Find Available FM Channels in Your Area

Before attempting any of the procedures below, you should park your vehicle in a safe location. Do not attempt to set up your FM channels or any Stratus 7 function while driving.

PowerConnect allows you to listen to Sirius audio through your vehicle's FM radio. You will first need to find an available FM channel, which is a channel that is not being used by an FM radio station in your area. When you tune your FM radio to an available channel, you should only hear static or silence - not talk or music.

Once you have found an available channel, you need to tune Stratus 7's built-in transmitter to the same channel to receive Sirius sound through your vehicle's radio.

We recommend one of the following methods to find an available FM channel:

1. Use the SiriusXM FM Channel Finder

Use the SiriusXM FM Channel Finder at siriusxm.ca/fm. Go to the website and enter your zip code. The Channel Finder will suggest a list of available FM channels in your area. For convenience, write down or print out the list.

Tune Stratus 7 to a favorite Sirius channel (or to channel 184, if it's not yet activated). Turn on your vehicle's FM radio. Pick the first FM channel on your Channel Finder list and tune the FM radio to that channel. If you do not hear a local FM station broadcast, then tune Stratus 7 to the same FM channel. (Refer to "Set and Select an FM Channel" on page 41.) You should hear the Sirius channel through your vehicle's radio. If you are satisfied with

Configuring Your Stratus 7

the sound quality, you're done! If this FM channel doesn't work well for you, work down the list until you find an FM channel that allows you to hear Sirius clearly.

OR

2. Manually tune through your local FM channels

Manually tune through your local FM channels on your vehicle's FM radio. Turn on your vehicle's FM radio. Start at 88.1 and use the 'Manual' tune function on your vehicle's FM radio to tune through each FM channel one-by-one (88.1 followed by 88.3 etc.) to locate channels that aren't being used by a local FM radio station. Write down each FM channel that has only static or silence on it, until you reach 107.9. Once you have created your list of available FM channels, you will need to find the one that provides the best match for Stratus 7.

Tune Stratus 7 to a favorite Sirius channel (or to channel 184, if it's not yet activated). Pick the first FM channel on your list and tune the FM radio to that channel. Then tune Stratus 7 to the same FM channel. (Refer to "Set and Select an FM Channel" on page 41.) You should hear the Sirius channel through your vehicle's radio. If you are satisfied with the sound quality, you're done! If this FM channel doesn't work well for you, work down the list until you find an FM channel that allows you to hear Sirius clearly.



NOTE! You may find an FM channel with static or silence that does not work with Stratus 7. It is possible that some type of inaudible interference is present that prevents reception of Stratus 7 broadcast. Your only options are to use another FM channel or a different audio connection method.

Configuring Your Stratus 7



TIP! If you regularly drive from one location to another, such as your daily commute, you may need to use different FM channels along your route for best performance. If this is the case, we recommend saving the best FM channels as presets on your FM radio and Stratus 7. Then you simply select and match the best channel for the area you are in.



TIP! It will be much more difficult to find available FM channels in large cities than in most suburban or rural locations. A direct audio connection using the Aux In Cable, Cassette Adapter, or professional installation is your best solution if you drive in or near large metropolitan areas.



NOTE! The SiriusXM FM Channel Finder relies on data from the Federal Communications Commission. The data may not reflect the latest stations in your area. In addition, local geography and weather conditions can impact reception, so your results may be different from the list.



NOTE! The performance of FM radios are different, based on manufacturer and vehicle style. Some may not work well with the type of FM transmitter used by Stratus 7. This is why we recommend a direct audio connection using the Aux In Cable or Cassette Adapter if they can be used in your vehicle. Professional installation can also resolve almost any performance issue.

Configuring Your Stratus 7

Turn FM Transmitter On/Off

The built-in FM Transmitter in Stratus 7 works with the *PowerConnect* Vehicle Dock, and is used when you choose to listen to Stratus 7 through your vehicle's FM radio.

To turn the FM Transmitter On or Off:

1. Press and hold **menu** until the menu options are displayed.
2. Press ▼ to scroll to and highlight **FM Settings** and press the **Select button**.
3. Press ▼ to scroll to and highlight **FM Transmitter** and press the **Select button**.
4. Press either ▼ or ▲ to scroll to and highlight either **On** or **Off** and press the **Select button**.
5. Press and hold **menu** to exit.

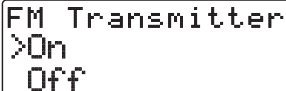

```
FM Transmitter
>On
Off
```



TIP! Stratus 7 is shipped with the FM Transmitter turned On by default.



TIP! The FM1 storage location is preset with FM channel 97.9.

Configuring Your Stratus 7

Set and Select an FM Channel

Stratus 7 allows you to easily store (i.e., preset) up to 5 different FM channels. At any time, you can select any one of these 5 FM presets to transmit audio from Stratus 7 to your vehicle's FM radio. Having a choice of 5 FM presets also makes it easy to switch to the appropriate FM channel as you travel from one area to another. Each FM preset is stored in its own storage location. You can easily add or edit the FM preset in any one of the 5 storage locations.



TIP! The FM1 storage location is preset with FM channel 97.9.

To set an FM preset:

1. Press and hold **menu** until the menu options are displayed.
2. Press ▼ to scroll to and highlight **FM Settings** and press the **Select button**.
3. **FM Channels** will be highlighted. Press the **Select button**.
4. Press ▼ to scroll to and highlight the storage location (FM1 to FM5) that you want to set or select, and press the **Select button**.
5. Change the FM Channel for the selected storage location by pressing ▼ and ▲ to tune in steps of .2, i.e., 99.3 to 99.5, and pressing ◀ and ▶ to tune in steps of 1, i.e., 99.3 to 100.3. Press the **Select button** to select the

```
FM Channels
>FM1 97.9
FM2 Empty
```

```
FM Channels
96.3 FM
```

Configuring Your Stratus 7

FM channel. The FM channel you selected will be confirmed on the display screen and Stratus 7 will tune to the FM channel.

- 6 Set your vehicle's FM radio to same FM channel.



IMPORTANT! You first need to find available FM channels in your area. Refer to "Find Available FM Channels in Your Area" on page 37.

To quickly select an FM channel from the preset list:

1. Press **FM** to display the current FM channel preset.
2. The currently selected FM preset is shown. To display and select the next FM preset press **FM**.
3. Repeatedly pressing **FM** will cycle through the FM presets. The FM channel displayed will be selected. To return to the main display screen, allow the screen to time out.
4. Set your vehicle's FM radio to the same FM channel.

```
017 Jam_ON  ll  
97.9 FM
```

```
017 Jam_ON  ll  
106.1 FM
```

Configuring Your Stratus 7

Jump Settings

Jump can be set to jump to the traffic and weather channel of one of the 20 most congested cities. You'll need to select the desired city from the list.

To configure jump:

1. Press and hold **menu** until the menu options are displayed.
2. Press ▼ to scroll to and highlight **Jump Settings** and press the **Select button**.
3. A list of cities will be displayed. Press ▼ or ▲ to scroll to and highlight your desired location and press the **Select button**.
4. Press and hold **menu** to exit.

```
Choose Traffic
>SF
STL
```

Configuring Your Stratus 7

Display

The Display option allows you adjust the brightness and contrast of Stratus 7's display to improve its visibility in different lighting conditions. You also can set the mode of the display screen to show channel name or category name information.

To change the display's brightness or contrast:

1. Press and hold **menu** until the menu options are displayed.
2. Press ▼ to scroll to and highlight **Display** and press the **Select button**.
3. Press the **Select button** to choose **Brightness** or press ▼ to scroll to and highlight **Contrast** and press the **Select button**.
4. Press ◀ or ▶ to decrease or increase the brightness/contrast of the display.
5. Press the **Select button** to confirm the brightness setting.
6. Press and hold **menu** to exit.



Configuring Your Stratus 7

To change the display screen mode:

1. Press and hold **menu** until the menu options are displayed.
2. Press ▼ to scroll to and highlight **Display** and press the **Select** button.
3. Press ▼ to scroll to and highlight **Mode** and press the **Select** button.
4. Press ▼ or ▲ to scroll to and highlight **Channel Name** or **Category Name** and press the **Select** button.

```
Mode
>Channel Name
Category Name
```

Channel Name displays the name of the channel at the top of the display screen, and Category Name displays the name of the category for the currently tuned channel.

```
072 RealJazz    11
Luther Hughes An
Spectacular
```

Channel Name

```
072 JzStndrd   11
Luther Hughes An
Spectacular
```

Category Name

5. Press and hold **menu** to exit.

Configuring Your Stratus 7

Audio Level

The audio level of Stratus 7 can be adjusted when an audio connection is made between the dock and the vehicle's stereo system. Audio level is used to adjust Stratus 7's volume level to match the volume of other audio sources you may use, such as a CD player, other FM stations, or an MP3 player.

Do not use the audio level as a volume control. Use the volume control on your vehicle stereo instead.

To adjust the audio level:

1. Press and hold **menu** until the menu options are displayed.
2. Press ▼ to scroll to and highlight **Audio Level** and press the **Select button**.
3. Press ◀ to decrease or ▶ to increase the audio level.
4. Press the **Select button** to confirm the new audio level setting.
5. Press and hold **menu** to exit.



Configuring Your Stratus 7

Factory Default

You can clear all of your personal settings, such as favorite channels, and return the Radio to its original out-of-the-box settings.

To restore Stratus 7 to the factory defaults:



NOTE! Restoring defaults permanently removes all personal settings.

1. Press and hold **menu** until the menu options are displayed.
2. Press ▼ to scroll to and highlight **Factory Default** and press the **Select button**.
3. Press ▲ to scroll to and highlight **Yes** and press the **Select button**.
4. A warning screen will be displayed. If you are certain that you want to reset your Stratus 7 to the factory defaults, press ▲ to scroll to and highlight **Yes** and press the **Select button**.
5. The Radio will display **Restoring**, and will be restored to the factory settings.
6. Press and hold **menu** to exit.

```
Restore?  
Yes  
>No
```

```
Are You Sure?  
Yes  
>No
```

```
Restoring
```

Troubleshooting

Stratus 7 has been designed and built to be trouble-free but if you experience a problem, try this:

- Check that all connections are firm and secure.
- Make sure the vehicle power socket is clean and free of corrosion.
- Make sure you have connected Stratus 7 as described in this User Guide. Verify that the PowerConnect Power Adapter is plugged into the vehicle's cigarette lighter or power adapter socket, and that the LED on the PowerConnect Power Adapter is lit (on). If not, your vehicle may need to be running to provide power to the socket.

If you see this on the screen:	Try this:
Check Antenna Connection	<ul style="list-style-type: none">• The satellite antenna is not connected to the Home Dock.• Check the satellite antenna connection to the Home Dock.
Acquiring Signal	No satellite signal is being received. <ul style="list-style-type: none">• Check for obstacles over or around the satellite antenna.• Change the location of the antenna to eliminate nearby obstacles (buildings, trees, overhangs, etc).
Invalid Channel	<ul style="list-style-type: none">• You have attempted to tune to a channel that you have not subscribed to, or does not exist. Select a channel to which you have subscribed.
Firmware Updating	<ul style="list-style-type: none">• Your Stratus 7 is being updated over the air with the latest software. Wait until the update is done.

Troubleshooting

If this happens:	Try this:
Radio does not power on	<ul style="list-style-type: none">• AC Power Adapter is not connected, or the AC outlet into which it is plugged is not working.• Check that the AC Power Adapter is connected to the home dock. Try plugging the AC Power adapter into a different outlet.
Audio fades or has static when listening	<ul style="list-style-type: none">• If using connecting to your home entertainment system, check the audio cable connections.• If using amplified speakers, check that the audio connection to the radio.• Refer to the section, "Connect the Home Dock to a Home Stereo System or Powered Speakers" on page 12.
No sound	<ul style="list-style-type: none">• The audio cables are not correctly connected. Check the audio cables at the home entertainment system and the radio.• The amplified speakers are not plugged in, or not turned on. Verify that they are plugged in and turned on.• Refer to the section, "Connect the Home Dock to a Home Stereo System or Powered Speakers" on page 12.

Product Specifications

System

Power Requirements:	5 Volts DC, 1.5A, Center Positive
Operating Temperature:	5° to +40° C (23° to 104° F)

Stratus 7 Radio

Dimensions:	4.5 in (W) x 1.9 in (H) x 0.7 in (D) 115 mm (W) x 48 mm (H) x 17 mm (D)
Weight:	2.3 oz (66 g)

Home Dock

Dimensions:	4.49 in (W) x 1.41 in (H) x 2.16 in (D) 114 mm (W) x 36 mm (H) x 55 mm (D)
Weight (without adapter):	1.8 oz (50 g)
Weight (with adapter):	1.9 oz (54 g)
Audio Connector:	1/8 in (3.5 mm) female
Audio Output:	18mW Left + 18mW Right @ 16 ohms
Signal-to-noise (S/N):	Greater than 70dB

Remote Control

Dimensions:	1.6 in (W) x 4.7 in (H) x 0.63 in (D) 41 mm (W) x 120 mm (H) x 64 mm (D)
Weight:	2.1 oz (60 g)
Battery:	CR2032 (3 Volts)

Home Power Adapter

Input:	100-240 V AC, 50-60 Hz, 0.2 A
Output:	5.0 V DC, 1.0 A

Indoor/Outdoor Home Antenna

Type:	SiriusXM Indoor/Outdoor
Connector:	SMB female
Cable Length:	Approximately 20 ft (6.1 m)

Stereo Audio Cable

Connectors:	1/8 in (3.5 mm) stereo male to RCA left & right
Cable Length:	Approximately 5.9 ft (180 cm)

Patent Information

Patent Information

It is prohibited to, and you agree that you will not, copy, decompile, disassemble, reverse engineer, hack, manipulate, or otherwise access and/or make available any technology incorporated in this product. Furthermore, the AMBE® voice compression software included in this product is protected by intellectual property rights including patent rights, copyrights, and trade secrets of Digital Voice Systems, Inc. The software is licensed solely for use within this product. The music, talk, news, entertainment, data, and other content on the Services are protected by copyright and other intellectual property laws and all ownership rights remain with the respective content and data service providers. You are prohibited from any export of the content and/or data (or derivative thereof) except in compliance with applicable export laws, rules and regulations. The user of this or any other software contained in a Sirius XM Radio Inc is explicitly prohibited from attempting to copy, decompile, reverse engineer, hack, manipulate or disassemble the object code, or in any other way convert the object code into human-readable form.

IC Statement

Warning

Changes or modifications not expressly approved by the manufacturer could void the user's authority to operate the equipment.

Canadian Compliance

This Class B digital apparatus complies with Canadian ICES-003.

IC STATEMENT

Operation is subject to the following two conditions: (1) this device may not cause interference, and (2) this device must accept any interference, including interference that may cause undesired operation of the device. For product available in the Canada market, only channel 1-11 can be operated. Selection of other channels is not possible. This device and its antenna(s) must not be co-located or operation in conjunction with any other antenna or transmitter. To reduce potential radio interference to other users, the antenna type and its gain should be so chosen that the equivalent isotropically radiated power (e.i.r.p) is not more than that permitted for successful communication. IC Radiation Exposure Statement: This equipment complies with IC RSS-102 radiation exposure limits set forth for an uncontrolled environment. This equipment should be installed and operated with minimum distance 20cm between the radiator & your body.

Copyrights and Trademarks

© 2016 Sirius XM Canada Inc. "SiriusXM", the SiriusXM logo, channel names and logos are trademarks of Sirius XM Radio Inc. and are used under license. "NFL" and the NFL Shield design are trademarks of the National Football League. NASCAR® is a registered trademark of the National Association for Stock Car Auto Racing, Inc. The NBA and NBA member team identifications are the intellectual property of NBA Properties, Inc. and the respective NBA member teams. © 2016 NBA Properties, Inc. All rights reserved. NHL and the NHL Shield are registered trademarks of the National Hockey League. © NHL 2016. Elvis Radio logo © EPE Reg. U.S. Pat & TM off. CFL® is a registered trademark of the Canadian Football League. All other trademarks, service marks, images and logos are property of their respective owners and are used with permission. All Rights Reserved. Required subscription sold separately. Premier subscription required for some channels. Prices and programming is subject to change. See Customer Agreement for complete terms at siriusxm.ca.

IMPORTANT NOTICE: REQUIRED SUBSCRIPTION

Hardware and subscription sold separately, and activation fee required. Other fees and taxes may apply. **Subscriptions governed by SiriusXM Customer Agreement; see siriusxm.ca.** Prices and programming are subject to change. **Service automatically renews into the subscription Package you choose (which may differ from the Package which arrived with the Radio), for additional periods of the same length, and automatically bills at the then current rates, after any complimentary trial or promotional period ends, until you call us at 1-888-539-7474 to cancel.**

Owners Record

The model number is located below and the Sirius ID is located on the label on the back of Stratus 7.

Record the Sirius ID in the space provided below. Refer to these numbers whenever you call your dealer regarding this product.

Model Number: SSV7

Sirius ID: _____

Indoor/Outdoor Antenna Template

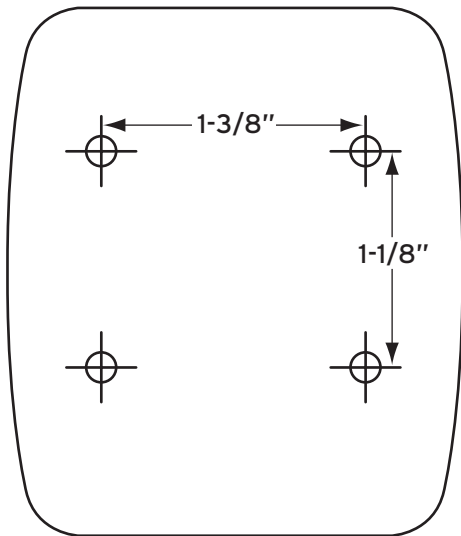

www.siriusxm.ca

**Sirius XM Canada Inc.
135 Liberty St. - 4th floor
Toronto, Ontario, M6K 1A7**

1-888-539-7474

© 2016 Sirius XM Canada Inc.

Stratus 7 User Guide 161129a