



User Guide

**Stratus 7
Radio & Vehicle Kit**

Table of Contents

Introduction	4	FM Transmitter	53
General Precautions	5	Settings	55
Warnings	6	Troubleshooting	64
What's in the Box?	8	Specifications	65
Stratus 7 Front Panel	10	IC Statement	66
PowerConnect Vehicle Dock	11	Copyrights and Trademarks	67
Vehicle Installation	13	Sirius ID	68
Step 1: Choose a Location for Your Radio	13		
Step 2: Install the Dash or Vent Mount ..	15		
Step 3: Mount the Magnetic Mount			
Antenna	19		
Step 4: Route the Magnetic Mount			
Antenna Cable	24		
Step 5: Connect the Magnetic Mount			
Antenna and PowerConnect Power			
Adapter	35		
Step 6: Connecting Your Stratus 7 to Your			
Vehicle's Audio System	36		
Subscribing to the SiriusXM			
Service	45		
Operation	46		
Display Screen Information	46		
Changing Channels and Categories	47		
Selecting Channels Directly (Direct			
Tuning)	47		
Channel Presets	48		
FM Presets/Menu Button	49		
Jump Button	50		
Menu Options	51		
Sirius ID	52		

Introduction

Here's your new Stratus 7 Radio

Your new Stratus 7 comes with everything you need to enjoy SiriusXM in your car. With available accessories you can use your Stratus 7 just about anywhere.

Your new Stratus 7 gives you powerful features:

- Easy-to-read 3-line display.
- *PowerConnect* so you can listen to SiriusXM through your car's FM stereo. An FM Presets button makes transmitter frequency changes quick and easy.
- Jump button that lets you jump to and from your favourite channel with the touch of just one button.

Use this manual to familiarize yourself with all of your Stratus 7's features and capabilities. For the latest information about your Stratus 7 and other products and accessories, visit siriusxm.ca.

Introduction

General Precautions

Liquid Crystal Precautions

If the LCD screen on the radio is damaged, do not touch the liquid crystal fluid. If any of the following situations happen, take the action indicated:

1. If the liquid crystal fluid comes in contact with your skin, wipe the skin area with a cloth and then wash the skin thoroughly with soap and running water.
2. If the liquid crystal fluid gets into your eye, flush the eye with clean water for at least 15 minutes. Seek medical care.
3. If the liquid crystal fluid is ingested, flush your mouth thoroughly with water. Drink large quantities of water and induce vomiting. Seek medical care.



Safety Precautions

Be sure to observe the following warnings. Failure to follow these safety instructions and warnings may result in a serious accident.

- Do not operate your Stratus 7 in a way that might divert your attention from driving safely. As a driver, you alone are responsible for safely operating your vehicle in accordance with traffic safety laws at all times.
- Do not install the unit where it may obstruct your view through the windshield, or of your vehicle's indicator displays.
- Do not install the unit where it may hinder the function of safety devices such as an airbag. Doing so may prevent the airbag from functioning properly in the event of an accident.
- Be sure the unit is installed as described in the installation instructions which accompany each accessory kit. Sirius XM Canada Inc is not responsible for issues arising from installations which were not installed according to the

Introduction

instructions.

- To avoid short circuits, do not open the unit, and never put or leave any metallic objects (coins, tools, etc.) inside the unit.
- If the unit emits smoke or unusual odors, turn the power off immediately, and disconnect the unit from any power source.
- Do not drop the unit or subject it to strong shocks.
- If the unit doesn't seem to be working properly, turn the unit off, wait 10 seconds and then turn it on again.
- The installation and use suggestions contained in this manual are subject to any restrictions or limitations that may be imposed by applicable law. The purchaser should check applicable law for any restrictions or limitations before installing and/or operating this unit.



Warnings

Operating Temperature

The Stratus 7 is designed to operate between -20° to $+85^{\circ}$ C (-4° to $+185^{\circ}$ F). Avoid leaving the radio in a vehicle or elsewhere where the temperature may fall outside this range. Extreme temperatures or extreme temperature fluctuations can degrade the performance of the LCD display screen, and possibly damage it.

Cleaning and Maintenance

If the radio or accessories become dirty, turn the power off and wipe it clean with a soft cloth. Do not use hard cloths, strong cleaning fluids, paint thinner, alcohol, or other volatile solvents to clean. These may cause damage to the radio.

Introduction

PowerConnect Power Adapter

The *PowerConnect Vehicle Dock* cannot be powered directly from a vehicle's 12VDC power system. It must be powered from the vehicle's cigarette lighter or similar power port using the included *PowerConnect Power Adapter*. Connecting the *PowerConnect Vehicle Dock* directly to the vehicle's 12VDC power system may result in damage to the *PowerConnect Vehicle Dock* or *Stratus 7 Radio*, or both.

Introduction

What's in the Box?

The following items are included with your purchase of the Stratus 7 radio:

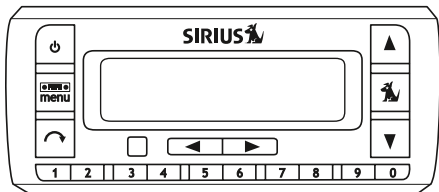

Stratus 7 Radio

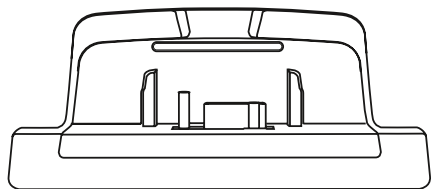

PowerConnect Vehicle Dock

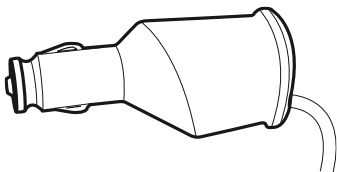

PowerConnect Power Adapter

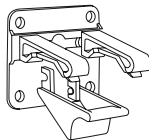
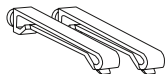

Vent Mount
and Extended
Vent Clamps

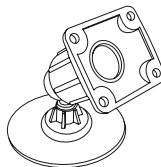

Dash Mount

Introduction

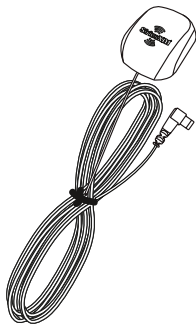

Magnetic Mount
Antenna



Antenna & Dash Mount
Alcohol Preparation Pads

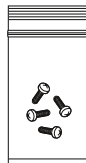

Screws



Aux In Cable

Unpack your Stratus 7 radio carefully and make sure that everything shown is present. If anything is missing or damaged, or if your the radio fails to operate, notify your dealer immediately. We recommend that you retain the original carton and packing materials in case you need to ship your radio in the future.

Introduction

Stratus 7 Front Panel

The following section describes the Stratus 7's buttons and controls.

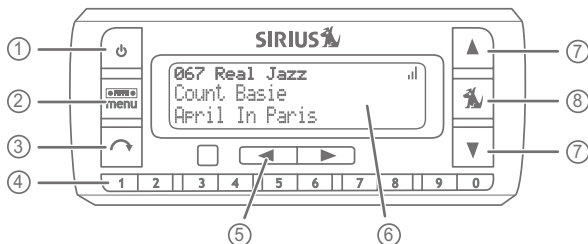

- 1. Power Button:** Turns the Stratus 7's power **ON** and **OFF**.
- 2. FM Presets/Menu Button:** Selects between different preset frequencies used by the built-in wireless FM transmitter. Press and hold to access **Menu Options** to make setup and feature changes.
- 3. Jump Button:** Jumps to a pre-selected channel.
- 4. Preset/Direct Tune Buttons (0 - 9):** Sets and selects preset channels. Also lets you directly tune channels by entering the channel number.
- 5. Category < > Buttons:** Navigates through the Category List screen which displays channel categories.
- 6. LCD Display:** Displays information about the Stratus 7's operation and about the program that is playing.
- 7. Channel Up/Down Buttons:** Navigates through channels and display screens.
- 8. Select Button:** Selects items highlighted on the display screen. When at the Default display screen, a press-and-release will display a prompt to enter a channel number.

Introduction

PowerConnect Vehicle Dock

Colour-Coded Connections

The colour-coded *PowerConnect* Vehicle Dock makes it simple to connect. Just match the colours on the cable ends to the colours on the dock to see what goes where.

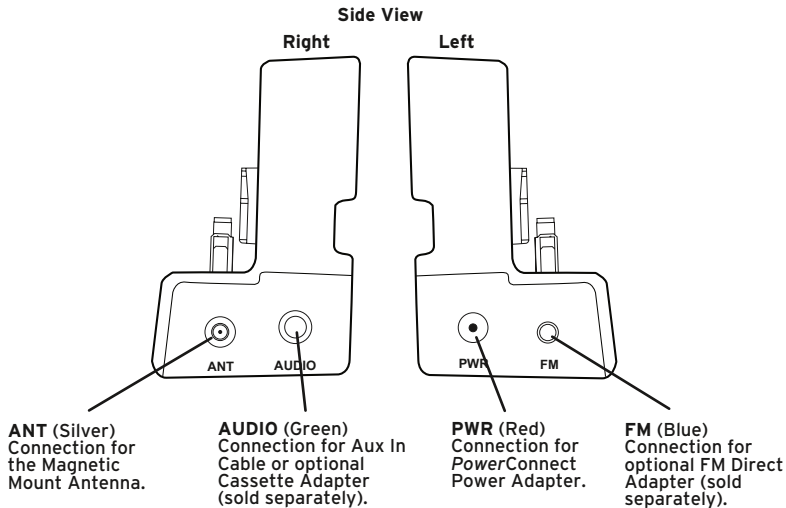

Introduction

Wire Guide

The *PowerConnect Vehicle Dock* has a channel across the back to help organize the wires connected to the dock. If you need to bring a wire from one side of the dock to the other side, utilize the wire guide channel to keep the wires tidy.

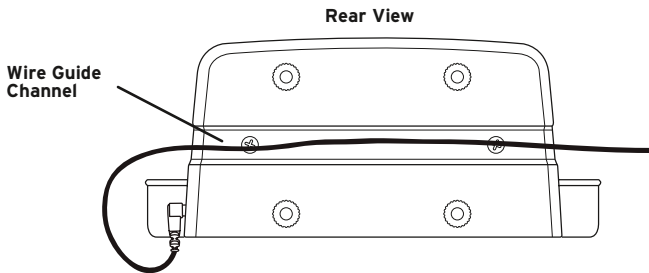

Vehicle Installation



WARNING! DO NOT attempt to install Stratus 7 while driving. Park your vehicle in a safe location before beginning installation.

Step 1: Choose a Location for Your Radio

When installing Stratus 7 in your vehicle, choose a location where it will not block your vision, interfere with the controls, or obstruct the air bag. The location should be easily accessible and provide good visibility of the display, and should not be located where it will be in direct sunlight, which will affect the visibility of the display screen.

Several examples of Stratus 7 mounted in a vehicle are shown: **A** is the on dash method using the Dash Mount, and **B** is the vent clip method using the Vent Mount.

Vehicle Installation

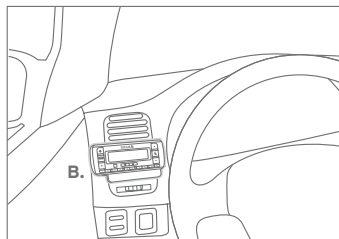
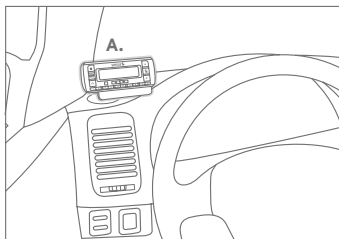
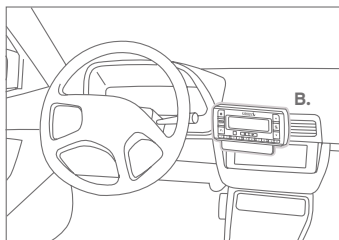
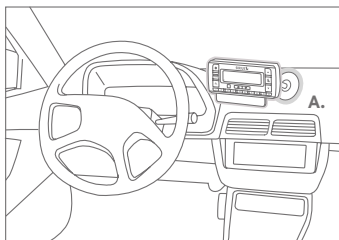

Vehicle Installation

Step 2: Install the Dash or Vent Mount

Follow the instructions on the next several pages for the mounting method you have selected.



NOTE! The PowerConnect Vehicle Dock included with this Vehicle Kit is compatible with the T-slot style Dash and Vent Mounts. If you have an existing Dash Mount or Vent Mount in your vehicle, you can continue to use it with this dock, and skip this step.

Installing the Dash Mount (A):



CAUTION! The adhesive used on the Adhesive Mount may be difficult to remove. Do not install this mount on leather surfaces (contact your automobile dealership if you are unsure about your dash surface), and make sure the air temperature is at least 60°F (15°C) during installation. If it's not at least 60°F, turn on the heater in your vehicle to bring the temperature up to 60°F.

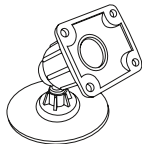

1. Locate a flat surface for the Adhesive Mount. Make sure there is ample room for the PowerConnect Vehicle Dock and Stratus 7 when installed.
2. Set the orientation of the Adhesive Mount before adhering it. Loosen the knob and adjust the adhesive foot for the location you selected in "Step 1: Choose a Location for Your Radio" on page 13.

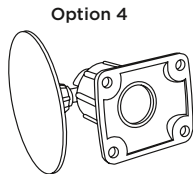
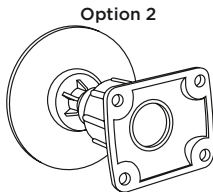
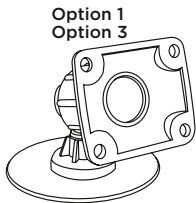

3. The dock mounting plate can be tilted in different directions. Adjust as

Vehicle Installation

necessary for your particular vehicle. When the orientation is correct, tighten the knob.

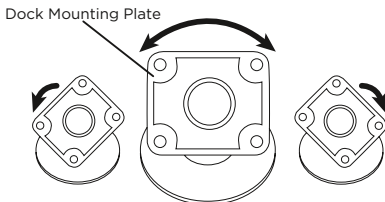
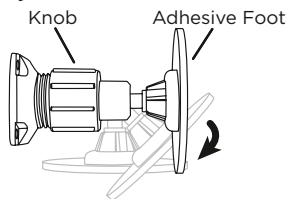

4. Attach the Adhesive Mount to the *PowerConnect Vehicle Dock* using the 4 provided screws. If you plan to use the wire guide channel across the back of the Vehicle Dock to organize the wires, do not fully tighten the screws. If not, tighten the screws.

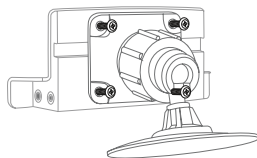

5. Once the cables have been attached to the dock, clean the mounting surface in the vehicle with the alcohol preparation pad and let it dry thoroughly.
6. Peel off the adhesive liner. Position, press, and hold the Adhesive Mount in place for 30 seconds.

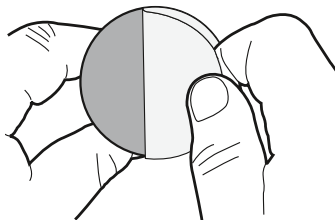

IMPORTANT! Allow the Adhesive Mount adhesive to cure (dry) for a minimum of 2-4 hours before using the mount. The best adhesion occurs after 24 hours.



TIP! To remove the Adhesive Mount, carefully lift the adhesive pad with your fingers or a spoon. Warming the pad with a hair dryer for several minutes will help soften the adhesive.

Vehicle Installation

Installing the Vent Mount (B):



IMPORTANT! To make the cable connections easier, wait until after you have connected all the cables to the dock before you attach the Vent Mount to a vent.

1. Locate a vent with horizontal louvers sturdy enough to hold your *PowerConnect Vehicle Dock and Stratus 7*.
2. If the vent louvers in your vehicle are recessed, you may need to use the longer vent clamps with the Vent Mount. If so, remove the shorter vent clamps and install the longer ones into the Vent Mount. Be sure to observe the orientation of the vent clamps as shown, and replace both vent clamps.

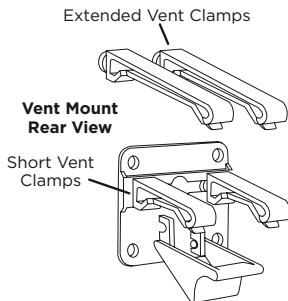

Vent Mount Rear View

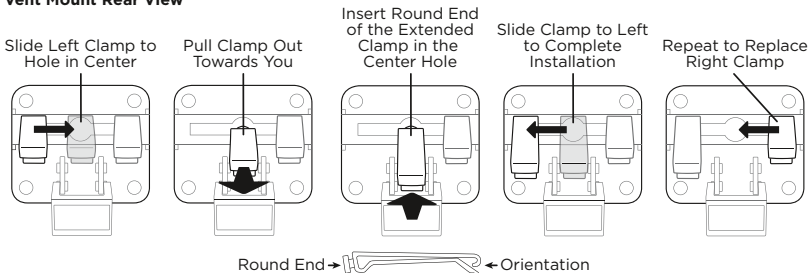

Vehicle Installation

3. Attach the Vent Mount to the *PowerConnect Vehicle Dock* using the 4 provided screws. If you plan to use the wire guide channel across the back of the Vehicle Dock to organize the wires, do not fully tighten the screws. If not, tighten the screws.

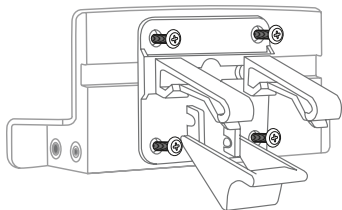

Note! For greater clarity, the next illustration does not show the dock attached to the Vent Mount, however, the dock should be attached before continuing.

4. Once the cables have been attached to the dock, push the Vent Mount onto the vehicle vent as shown (1) until it hooks on the rear of the vent louver (2).
5. Rest the foot against the bottom of the vent (2), and adjust the tilt of the Vent Mount by repositioning the foot to the other adjustment hole (3).

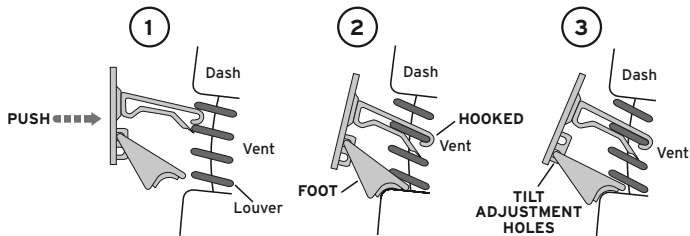

TIP! To remove the Vent Mount, push the mount into the vent. Then lift up until disengaged from the rear of the vent louver, and remove the Vent Mount.

Vehicle Installation

Step 3: Mount the Magnetic Mount Antenna

Mount the Magnetic Mount Antenna on the outside of your vehicle, on a horizontal surface that will always face the sky. The antenna contains a strong magnet which will stick to any metal part of your vehicle, but will not damage the vehicle.

To install the Magnetic Mount Antenna:

1. Choose the best location for your antenna considering your own personal situation. Pay particular attention to any accessories that you may have like luggage racks and how frequently you may use them.

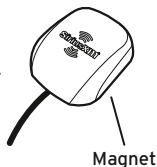

Sedan/Coupe: We recommend mounting the antenna above either the front windshield or the back window as shown.

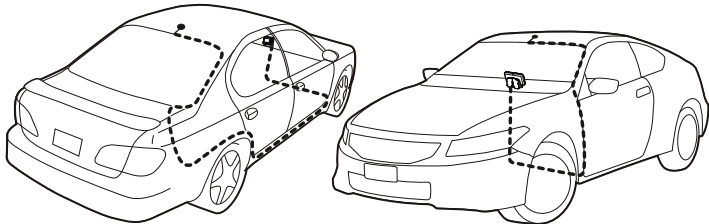

Vehicle Installation

SUV: We recommend mounting the antenna at the rear of the roof as shown.

Convertible: We recommend mounting the antenna at the leading edge of the trunk as shown.

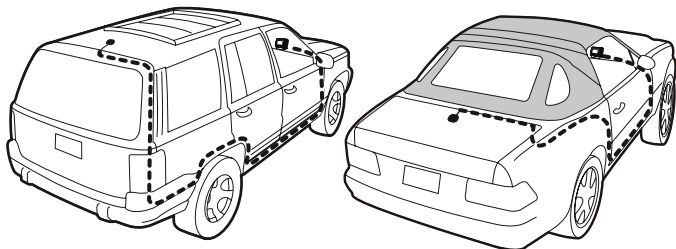

Pickup Truck: We recommend mounting the antenna above the front windshield as shown.

2. Clean the surface of the selected mounting location using the alcohol preparation pad and let it dry thoroughly.

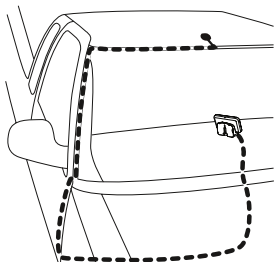

Vehicle Installation

3. Follow the Tips and Cautions shown on the next several pages, and place the antenna in the location you selected.

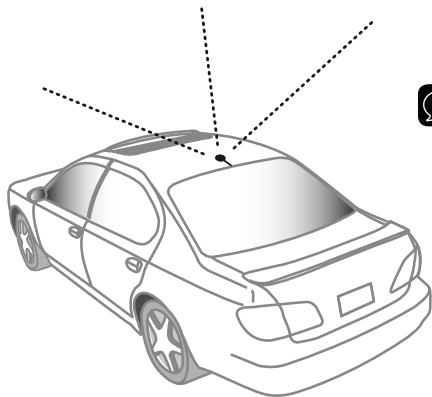

TIP! Mount the antenna on the roof (for most vehicles) or trunk (for convertibles) where it has a clear view of the sky in all directions.

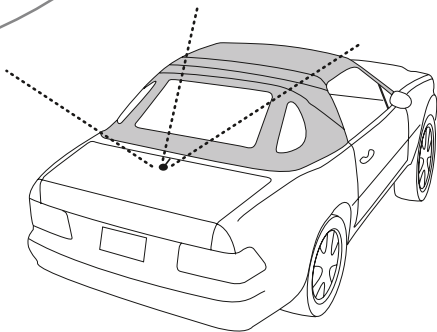

Vehicle Installation



CAUTION! Don't mount the antenna inside the vehicle, for example, on the dashboard.

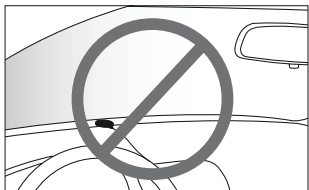

CAUTION! Don't mount the antenna on any of the vehicle's front, back or side pillars.

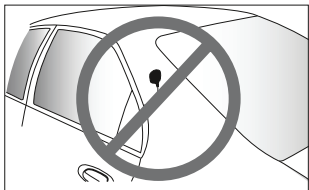

CAUTION! Don't mount the antenna close to a roof rack. Adjust the rack so it's further away from the antenna or move the antenna closer to the center of the roof.

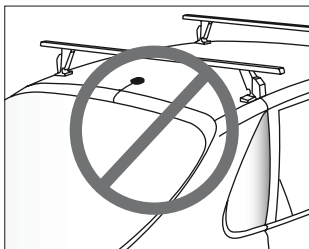

Vehicle Installation



CAUTION! Don't mount the antenna close to another antenna. Mount it at least 3 inches away.

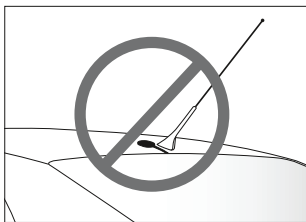

Vehicle Installation

Step 4: Route the Magnetic Mount Antenna Cable

Before you begin routing the antenna cable, read these general instructions for how to route and hide the antenna cable. Then route your antenna cable according to the instructions which follow for your specific type of vehicle.

Use a blunt plastic putty knife, a credit card, a plastic knife, or a similar blunt tool to lift the rubber window moulding

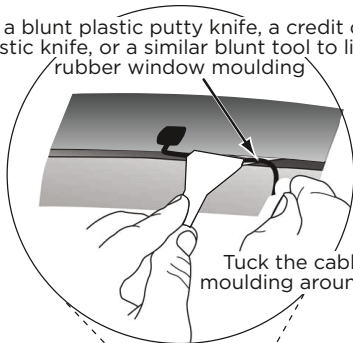

Tuck the cable under the moulding around the window

Feed cable under rubber moulding around window

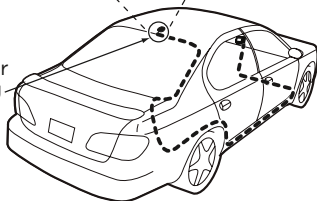

Vehicle Installation

Route cable out from under rear windshield moulding and tuck into weatherstripping around trunk opening

Avoid sharp bends by running cable through weatherstripping for several inches

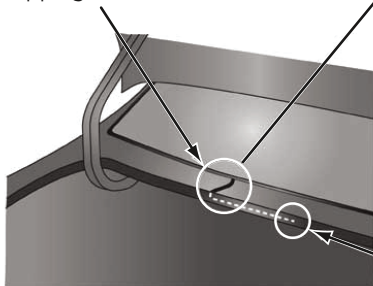

Pull weatherstripping from trunk opening



Tuck cable into weatherstripping. Route cable through weatherstripping several inches to avoid sharp bends

Pull cable out of weatherstripping and route through trunk to cabin

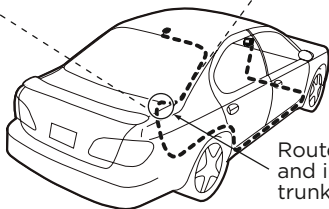

Route cable out of window moulding and into weatherstripping around trunk opening

Vehicle Installation

Bring cable out of weatherstripping and into trunk

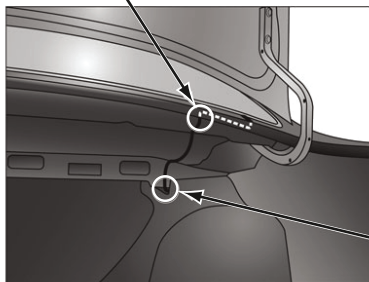

Route cable along trunk wall and into cabin through gap or conduit, along existing wiring harness

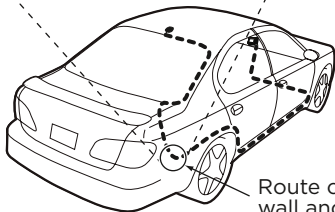

Route cable along trunk wall and into cabin

Vehicle Installation

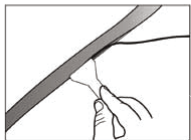

Use a blunt plastic putty knife or similar blunt tool to lift edge of interior trim and tuck cable under trim. Continue towards front of vehicle

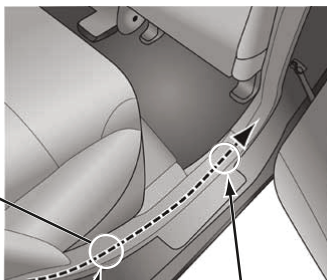

Route cable under trim or upholstery

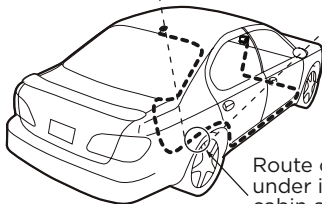

Route cable from trunk under interior trim, into cabin and towards front of vehicle

Continue routing cable under trim or carpet towards front of vehicle

Vehicle Installation

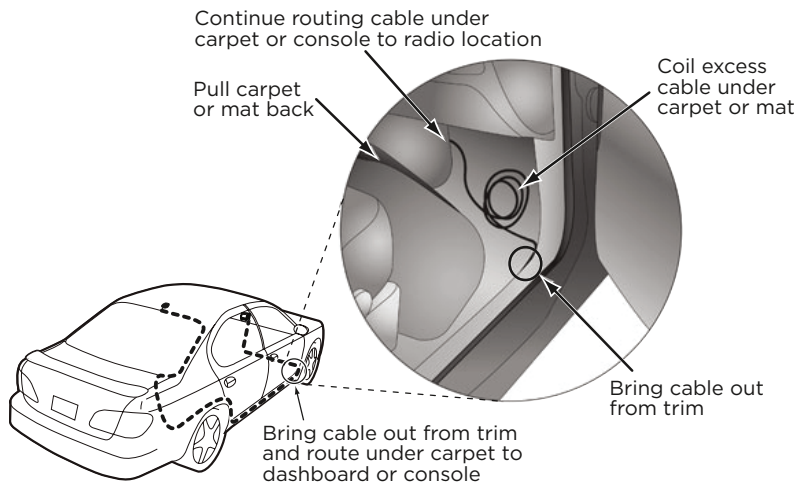

TIP! Always be careful to include enough slack in your cable to accommodate open doors or trunk lids. Use things typically found around the home, like electrical tape, to secure cables in areas so that hinges do not pinch the cable with the door. Hide any excess cable in the trim.

Vehicle Installation

Sedan/Coupe With Antenna Placed at the Rear of the Roof:

- 1.** Feed the antenna cable from the antenna underneath the rubber molding around the rear window. Use a blunt plastic putty knife or similar blunt tool to lift the rubber molding around the rear window and tuck the antenna cable underneath the molding. Route the antenna cable around and down the window to the lowest point. If your rear window does not have rubber molding, we recommend consulting a professional installer.
- 2.** Route the antenna cable out of the window molding and into the rubber weather stripping around the trunk opening. Lift the weather stripping from the opening and tuck the cable inside it, then replace the weather stripping. To avoid sharp bends in the cable, run the cable inside the weather stripping for a few inches, then remove the cable from the weather stripping inside the trunk. Keep the cable away from hinges, gears, etc., that could damage it.
- 3.** Route the cable out from the rubber weather stripping and along the trunk wall. Continue routing the cable into the vehicle cabin through a conduit or along an existing wiring harness.
- 4.** Route the cable through the main cabin area under the interior trim, towards the front of the vehicle. Use a blunt plastic putty knife or similar blunt tool to lift the plastic trim just enough to tuck the cable underneath. Avoid side airbag locations on back pillars and above the doors. Airbag locations are marked with "SRS" logos. Be careful not to crimp or cut the cable.

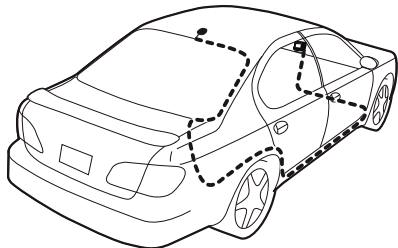

Vehicle Installation

5. Bring the cable out from the trim near the front of the cabin and route it under the carpet toward the dashboard or console. Coil any excess cable in a hidden location, such as under the carpet, keeping it away from any vehicle pedals or controls. Secure the excess cable with wire ties (purchased separately).
6. Bring the end of the cable out at the *PowerConnect* Vehicle Dock location. Leave yourself enough cable so you can easily connect it to the antenna connector of the dock.
7. Continue with "Step 5: Connect the Magnetic Mount Antenna and *PowerConnect* Power Adapter" on page 35.

Sedan/Coupe With Antenna Placed at the Front of the Roof

1. Feed the antenna cable from the antenna underneath the rubber molding around the windshield. Use a blunt plastic putty knife or similar blunt tool to lift the rubber molding around the windshield and tuck the antenna cable underneath the molding. Route the antenna cable around and down the windshield to the lowest point.
2. At the lowest corner of the windshield, route the cable out of the windshield molding and into the rubber weather stripping around the door opening. Lift the weather stripping from the opening and tuck the cable inside it, then replace the weather stripping. Run the cable inside of the weather stripping to the bottom of the door opening.
3. Pull the cable out of the weather stripping at the bottom of the door opening and route it under the carpet toward the dashboard. Coil

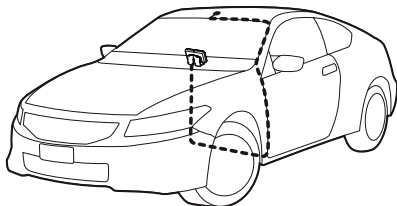

Vehicle Installation

any excess cable in a hidden location, such as under the carpet, keeping it away from any vehicle pedals or controls. Secure the excess cable with wire ties.

4. Bring the end of the cable out at the *PowerConnect Vehicle Dock* location. Leave yourself enough cable so you can easily connect it to the antenna connector of the dock.
5. Continue with “Step 5: Connect the Magnetic Mount Antenna and *PowerConnect Power Adapter*” on page 35.

Sport Utility Vehicle (SUV)

1. Feed the antenna cable underneath the rubber weather stripping of the rear tailgate window/door and route the cable along the rear hatch. Lift the weather stripping from the opening and tuck the cable inside it, then replace the weather stripping. Pull the cable out from weather stripping and route it into the cabin under the interior trim. Avoid hinges or gears that could crimp or cut the cable.
2. Route the cable through the SUV's main cabin area under the interior trim, towards the front of the vehicle. Use a blunt plastic putty knife or similar blunt tool to lift the plastic trim just enough to tuck the cable under underneath. Avoid side airbag locations on back pillars and above the doors. Airbag locations are marked with “SRS” logos. Be careful not to crimp or cut the cable.
3. Bring the cable out from the

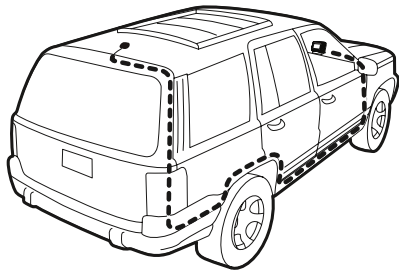

Vehicle Installation

trim near the front of the cabin and route it under the carpet toward the dashboard or console. Coil any excess cable in a hidden location, such as under the carpet, keeping it away from any vehicle pedals or controls. Secure the excess cable with wire ties (purchased separately).

4. Bring the end of the cable out at the *PowerConnect Vehicle Dock* location. Leave yourself enough cable so you can easily connect it to the antenna connector of the dock.
5. Continue with “Step 5: Connect the Magnetic Mount Antenna and *PowerConnect Power Adapter*” on page 35.

Convertible

1. Bring the antenna cable from the antenna into the trunk at the front edge of the trunk lid. Keep any bends in the cable loose. Tape or tie the cable along the inside of the trunk lid to the trunk lid hinge strut.
2. Allow enough slack in the cable so the trunk lid can easily open and close and keep the cable away from hinges, gears, etc., that could crimp or cut it. Route the cable along the trunk wall and into the cabin through a conduit or along an existing wiring harness.
3. Route the cable through the main cabin area under the interior trim, towards the front of the vehicle. Use a blunt plastic putty knife or similar blunt tool to lift the plastic trim just enough to tuck the cable under underneath. Avoid side airbag locations on back pillars and above the doors. Airbag locations are marked with “SRS” logos. Be careful not to crimp or cut the cable.

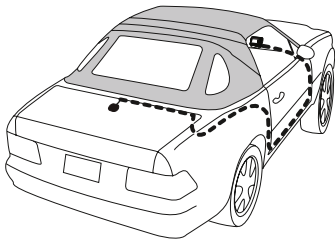

Vehicle Installation

4. Bring the cable out from the trim near the front of the cabin and route it under the carpet toward the dashboard or console. Coil any excess cable in a hidden location, such as under the carpet, keeping it away from any vehicle pedals or controls. Secure the excess cable with wire ties (purchased separately).
5. Bring the end of the cable out at the *PowerConnect Vehicle Dock* location. Leave yourself enough cable so you can easily connect it to the antenna connector of the dock.
6. Continue with "Step 5: Connect the Magnetic Mount Antenna and *PowerConnect Power Adapter*" on page 35.

Pickup Truck

1. Use a blunt plastic putty knife or similar blunt tool to lift the rubber molding around the windshield and tuck the antenna cable underneath it.
2. Continue tucking the cable underneath the windshield molding around the windshield to the lowest corner.
3. At the lowest corner of the windshield, route the cable out of the windshield molding and into the rubber weather stripping around the door opening. Lift the weather stripping from the opening and tuck the cable inside it, then replace the weather stripping. Run the cable inside of the weather stripping to the bottom of the door opening.
4. Pull the cable out of the weather stripping at the bottom of the door opening and route it under the carpet toward the dashboard. Coil

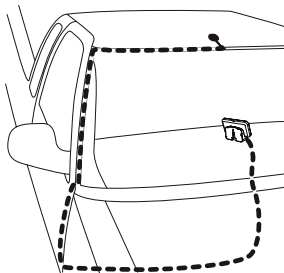

Vehicle Installation

any excess cable in a hidden location, such as under the carpet, keeping it away from any vehicle pedals or controls. Secure the excess cable with wire ties.

- 5.** Bring the end of the cable out at the *PowerConnect Vehicle Dock* location. Leave yourself enough cable so you can easily connect it to the antenna connector of the dock.
- 6.** Continue with “Step 5: Connect the Magnetic Mount Antenna and *PowerConnect Power Adapter*” on page 35.

Vehicle Installation

Step 5: Connect the Magnetic Mount Antenna and PowerConnect Power Adapter

1. Plug the Magnetic Mount Antenna into the **silver ANT** connector at the side of the PowerConnect Vehicle Dock.

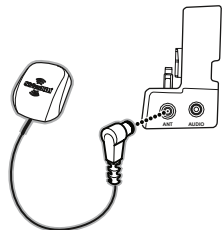

2. Insert the PowerConnect Power Adapter into your vehicle's cigarette lighter or power adapter socket.

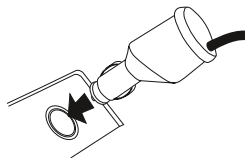

3. Plug the PowerConnect Power Adapter into the **red PWR** connector at the side of the PowerConnect Vehicle Dock.

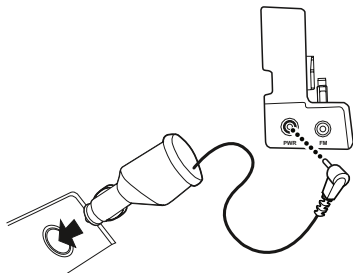

Vehicle Installation

Step 6: Connecting Your Stratus 7 to Your Vehicle's Audio System

To play audio through your vehicle's stereo or FM radio, decide on one of the following audio connection options:

- **Option 1: Best:** Use the included **Aux In Cable** if your vehicle's stereo system has an auxiliary input connection. Refer to your vehicle's owners manual to find the location of the auxiliary input jack, or consult the vehicle dealer.

Tip

The auxiliary input jack may be located on the face plate of the vehicle radio, on the back of the radio, anywhere on the front dash panel, inside the glove compartment, or inside the center console in between the front seats.

- **Option 2: Better:** Use a **Cassette Adapter** if your vehicle has a built-in cassette player. Cassette Adapters are sold separately and can be purchased from an electronics retailer, or go to www.sirius.ca.
- **Option 3: Good:** Use the **PowerConnect** feature in the Stratus 7. *PowerConnect* plays the audio through your vehicle's FM radio.
- **Option 4: Best:** Use the **FM Direct Adapter**. If none of the previous three audio connection options will work in your vehicle, then you will need to use the FM Direct Adapter (FMDA25C) (sold separately). The FMDA25C needs to be installed by a professional installer and directly connects your radio to your vehicle's FM radio. To learn more, check with the retailer where you bought your radio, or go to www.sirius.ca.

Follow the installation instructions in the next several sections for the audio connection option that you have selected.

Vehicle Installation

Option 1: Aux In Cable Installation Instructions

1. Plug the Aux In Cable into the **green AUDIO** connector at the side of the PowerConnect Vehicle Dock.

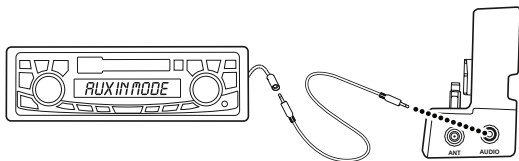

2. Plug the other end into the auxiliary input jack connection of your vehicle's stereo system.
3. If you are using the vent mounting method, attach the Vent Mount to the vent.

4. Insert your Stratus 7 into the dock, aligning the radio against the rear of the dock so that the rails on the dock fit into the mounting slots in the back of the radio.

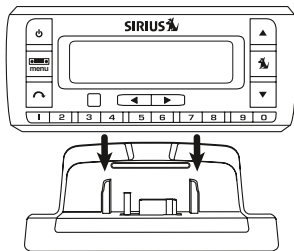

5. Power on your Stratus 7 by pressing the **Power** button.

Be sure the vehicle is outside and the antenna has a clear view of the sky. Verify that you are receiving the SiriusXM signal. There should at least be one bar on the upper right corner of the main display screen that denotes antenna signal strength. You can also press and hold **menu** and then press ▼ to scroll to and highlight **Signal**. Press the **Select** button. The Satellite and Terrestrial bars show the strength of the signal being received. If the signal

Vehicle Installation

reception is good, press and hold **menu** to return to the main display screen. You are ready to make the audio connection.



7. Ensure that the Stratus 7 is tuned to channel 184. Upon power up, the Stratus 7 should tune to channel 184 by default, when it's not yet activated. If it's not on channel 184, refer to "Operation" on page 46 to learn about how to tune a channel.
8. Turn on your vehicle's stereo system. Set it to play input from the auxiliary input source.
9. You should hear Sirius channel 184 through your vehicle's stereo system. You are now ready to subscribe your Stratus 7.
10. The audio level output of the Stratus 7 can be increased or decreased as necessary to match the audio levels of other sources in your vehicle. Refer to "Audio Level" on page 57.
11. If you are using the wire guide channel across the back of the Vehicle Dock to organize the wires, place the wires in the guide and then tighten the 4 screws to securely attach the mount. Then the installation is complete.

If the signal reception is good, but there is no audio when tuned to channel 184, be sure the vehicle's stereo system is set to the correct source, i.e., auxiliary input source (step 8). Also be sure that the audio level is set high enough to be heard (step 10). Refer to "Troubleshooting" on page 64 for additional help.

Vehicle Installation

Option 2: Cassette Adapter Installation Instructions

1. Plug the Cassette Adapter into the **green AUDIO** connector at the side of the PowerConnect Vehicle Dock.

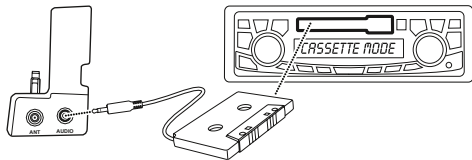

2. Insert the Cassette Adapter in the vehicle's cassette deck. You may need to turn on your vehicle's stereo system in order to do so.
3. If you are using the vent mounting method, attach the Vent Mount to the vent.
4. Insert your Stratus 7 into the dock, aligning the radio against the rear of the dock so that the rails on the dock fit into the mounting slots in the back of the radio.
5. Power on your Stratus 7 by pressing the **Power** button.

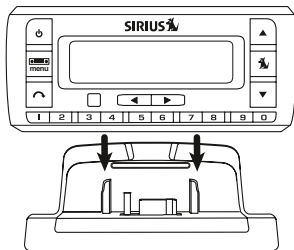

- Be sure the vehicle is outside and the antenna has a clear view of the sky. Verify that you are receiving the SiriusXM signal. There should be at least one bar on the upper right corner of the main display screen that denotes antenna signal strength. You can also press and hold **menu** and then press ▼ to scroll to and highlight **Signal**. Press the **Select** button. The Satellite and Terrestrial bars show the strength of the signal being received. If the signal

Vehicle Installation

reception is good, press and hold **menu** to return to the main display screen. You are ready to make the audio connection.



7. Ensure that the Stratus 7 is tuned to channel 184. Upon power up, the Stratus 7 should tune to channel 184 by default, when it's not yet activated. If it's not on channel 184, refer to "Operation" on page 46 to learn about how to tune a channel.
8. If you haven't done so, turn on your vehicle's stereo system. Set it to play input from the cassette source.
9. You should hear Sirius channel 184 through your vehicle's stereo system. You are now ready to subscribe your Stratus 7.
10. The audio level output of the Stratus 7 can be increased or decreased as necessary to match the audio levels of other sources in your vehicle. Refer to "Audio Level" on page 57.
11. If you are using the wire guide channel across the back of the Vehicle Dock to organize the wires, place the wires in the guide and then tighten the 4 screws to securely attach the mount. Then the installation is complete.

If the signal reception is good, but there is no audio when tuned to channel 184, be sure the vehicle's stereo system is set to the correct source, i.e., cassette source (step 8). Also be sure that the audio level is set high enough to be heard (step 10). Refer to "Troubleshooting" on page 64 for additional help.

Vehicle Installation

Option 3: *PowerConnect* Installation Instructions

1. Insert your Stratus 7 into the dock, aligning the radio against the rear of the dock so that the rails on the dock fit into the mounting slots in the back of the radio.)
2. Power on Stratus 7 radio by pressing the **Power** button.

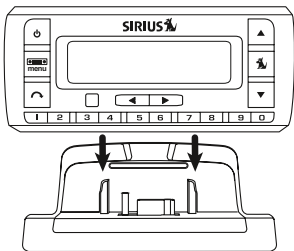

3. If you are using the vent mounting method, attach the Vent Mount to the vent.
4. Be sure the vehicle is outside and the antenna has a clear view of the sky. Verify that you are receiving the SiriusXM signal. There should be at least one bar on the upper right corner of the main display screen that denotes antenna signal strength. You can also press and hold **menu** and then press **▼** to scroll to and highlight **Signal**. Press the **Select** button. The Satellite and Terrestrial bars show the strength of the signal being received. If the signal reception is good, press and hold **menu** to return to the main display screen. You are ready to make the audio connection.



5. You'll first need to find an available FM channel. An available FM channel is one that's not being used by an FM radio station in your area. When you tune your FM radio to an available channel, you should only hear static or silence - not talk or music. We recommend one of the following methods to find an available FM channel:
 - a. Use the SiriusXM FM Channel Finder at siriusxm.ca. Go to the website

Vehicle Installation

and enter your zip code. The Channel Finder will suggest a list of available FM channels in your area. For convenience, write down or print out the list.

OR

- b. Manually tune through your local FM channels on your vehicle's FM radio. Locate and create a list of channels that aren't being used by any FM radio station. Write down the list. Once you have created your list of available FM channels, you will need to find the one that provides the best match for your Stratus 7.

Tip

You'll need to use the 'Manual' tune function on your vehicle's FM radio to tune through every FM channel one-by-one. Turn on your vehicle's FM radio. Start at 88.1 and use the 'Manual' tune function on your vehicle's FM radio to tune through each FM channel one-by-one (88.1 followed by 88.3 etc.) to locate channels that aren't being used by a local FM radio station. Write down each FM channel that has only static or silence on it, until you reach 107.9.

6. Ensure that the Stratus 7 is tuned to channel 184. Upon power up, the Stratus 7 should tune to channel 184 by default, when it's not yet activated. If it's not on channel 184, refer to "Operation" on page 46 to learn about how to tune a channel.
7. Pick the first FM channel on your list from step 4. Turn on your vehicle's FM radio (if you have not already done so) and tune it to this FM channel.

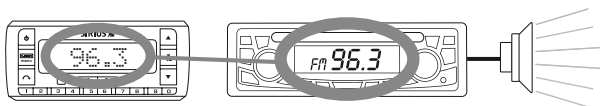

MATCH FM CHANNELS

Vehicle Installation

8. Set your Stratus 7 to transmit on the same FM channel that you have selected in step 4:
 - i. Press and hold **menu** until the menu options are displayed.
 - ii. Press ▼ to scroll to and highlight **FM Settings** and press the **Select button**.
 - iii. **FM Channels** will be highlighted. Press the **Select button**.
 - iv. Press ▼ to scroll to and highlight the storage location FM2. Press the **Select button**.
 - v. Tune to the FM channel you found in step 3. Press ▼ and ▲ to tune in steps of .2, i.e., 99.3 to 99.5. Press ◀ and ▶ to tune in steps of 1, i.e., 99.3 to 100.3. Press the **Select button** to select the FM channel.



```
FM Channels
96.3 FM
```

- vi. The FM channel you selected will be confirmed on the display screen. The Stratus 7 will tune to the FM channel.
9. You should hear Sirius channel 184 through your vehicle's FM radio. If you are satisfied with the sound quality, you're done! You are now ready to activate your Stratus 7.



```
FM Channels
>FM2 96.3
FM3 Empty
```

Vehicle Installation

- 10.** If the selected FM channel doesn't work well for you, work down the list of FM channels until you find one that allows you to hear SiriusXM clearly. Each time, you will need to tune your vehicle's FM radio to the FM channel and then set your Stratus 7 to transmit on the same FM channel (steps 7 & 8).
- 11.** If you are using the wire guide channel across the back of the Vehicle Dock to organize the wires, place the wires in the guide and then tighten the 4 screws to securely attach the mount. Then the installation is complete.

If the signal reception is good, but there is no SiriusXM audio when tuned to channel 184, verify that both the radio and your vehicle's FM radio are tuned to the same FM channel (steps 7 & 8). Also ensure the chosen FM channel is a suitable one to use in your area (step 5). Verify that nothing is plugged into the **AUDIO** connector on the *PowerConnect* Vehicle Dock. Refer to "Troubleshooting" on page 64 for additional help.

Option 4: FM Direct Adapter (FMDA) Installation

The FMDA needs to be installed by a professional installer. Professional installation can help improve your radio's reception and significantly reduce the visibility of wires. To learn more, check with the retailer where you bought your radio, or go to www.siriusxm.ca.

Subscribing to the SiriusXM Service

The Stratus 7 works on the Sirius network and requires a Sirius subscription. Before you can start listening, please do the following:

1. Be sure that your Stratus 7 is correctly installed, is properly docked in the Vehicle Dock, and that the antenna is oriented to receive the SiriusXM signal.
2. Turn on the Stratus 7. After the startup sequence, it will update the channel line-up. Wait until the channel updates have completed before pressing any buttons.



Channel Updates
20% Completed

3. Once the channels have been updated, the radio will automatically tune to channel 184 and the display will change to Call 1-888-539-SIRIUS to Subscribe. You will not be able to listen to any other channels until you activate your SiriusXM subscription.

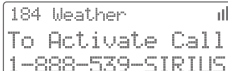

184 Weather ||
To Activate Call
1-888-539-SIRIUS

4. Use the Channel UP/DOWN buttons to tune to channel 0 to display your Stratus 7's unique 12-digit Sirius ID number (SID). Write the SID number down.

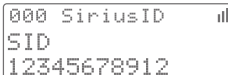

000 SiriusID ||
SID
12345678912

- The SID number is also available on your Stratus 7's packaging, and may also be accessed by pressing the FM Presets/Menu button and selecting Sirius ID.

5. Have your credit card handy and visit www.siriusxm.ca/activer and follow the prompts to activate your subscription. You can also call SiriusXM toll-free at: **1-888-539-7474**.
6. When you have successfully subscribed to the SiriusXM service your Stratus 7 will display an alert message. To continue, press any button.



184 Weather ||
Sub Updated
Press Any Key

You are now ready to begin enjoying SiriusXM!

Operation

Display Screen Information

Whenever you power your Stratus 7 ON, the previously-selected channel will automatically begin playing, and the Stratus 7's display screen will show the currently-tuned channel, the song or show being played, the artist name and other information. This screen is referred to as the Default display screen in this manual. The information displayed when listening to a typical broadcast is described below.

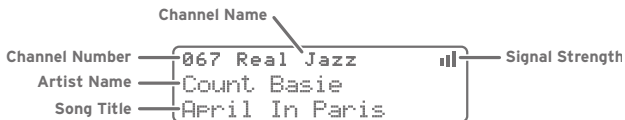

You can choose to have the channel name, category name, or the time displayed on the **Default** display screen.



To change the display, press-and-hold the **FM Presets/Menu** button, use the Channel UP/DOWN buttons and Select button to highlight and select **Settings > Display Options > Mode**, and then choose the desired display option. (See **Mode**, on page 62.)

Operation

Changing Channels and Categories

Pressing the Channel UP or DOWN button will cause the Stratus 7 to immediately tune to the next or previous channel.

Pressing the Category < or > button once will display a list of the channels in the current category, highlighting the currently-tuned channel. Use the Channel UP/DOWN buttons to navigate through the list, and press the Select button to choose a selected channel. Press the Category < or > buttons to scroll through all the different categories.

```
Pop
 002 Hits 1
>003 20s on 20
```

```
Rock
>028 The Spectru
 029 Jam ON
```

```
Elec/Dnc
>051 bpm
 052 electric ar
```

Selecting Channels Directly (Direct Tuning)

You can directly tune to any channel by entering its channel number. Momentarily press and release the Select button. At the display prompt, use the Preset/Direct tune (0 - 9) buttons to enter the channel's three-digit number.

```
067 Real Jazz  III
Enter Channel
# ____
```

Operation

Channel Presets

You can store up to 10 of your favourite channels as presets for quick access by pressing the **0 - 9** buttons.

Storing Channel Presets

To store a favourite channel as a preset, do the following:

1. Tune the Stratus 7 to the channel you want to store as a preset.
2. Press and hold for 1 second the numbered preset button (**0 - 9**) in which you want to store the channel. You will hear an audible beep and the display will confirm that the channel has been stored as a preset.





067 Real Jazz 
P3 Stored

Note: If the preset button already has a channel stored in it, the newly-stored channel will replace the original preset.

Selecting Presets

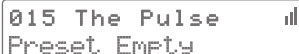
To tune to a preset channel, press and release one of the **0 - 9** buttons. If you press a preset button in which no channel has been saved, the **Preset Empty** message will be displayed.



015 The Pulse 
Preset Empty

Operation

FM Presets/Menu Button

If you are using the *PowerConnect* option between your Stratus 7 and your vehicle's audio system (see page 41), you can easily select between the five different preset FM transmitter frequencies without having to go through the Menu Options.

To quickly access the FM Transmitter menu, press the **FM Presets/Menu** button. If the FM Transmitter is set to **ON**: Each press of the **FM Presets/Menu** button will switch to the next preset FM Transmitter frequency.

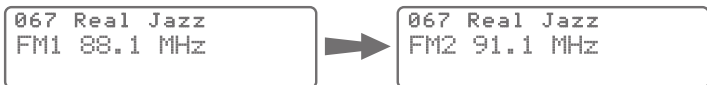

If the FM Transmitter is set to **OFF**: The **FM On/Off** screen appears. Use the Channel UP/DOWN buttons to highlight **On**, and press the Select button.

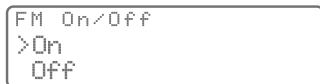

After selecting **On**, the **FM Presets** screen will appear. Each press of the **FM Presets/Menu** button will switch to the next preset FM Transmitter frequency.

Operation

Jump Button

Your Stratus 7 has a special preset button called the **Jump** button that lets you quickly tune to a channel that you want to access frequently, such as a music channel or a sports channel. Pressing the **Jump** button 'jumps' to the specific channel you have programmed into the **Jump** button; pressing the **Jump** button again 'jumps' back to your original channel.

Menu Options

Menu Options allows you to set and/or change the various features and settings of your Stratus 7. Press and hold the **FM Presets/Menu** button to display the **Menu Options** screen.

```
Menu Options  
>Sirius ID  
FM Transmitter
```

Use the Channel UP/DOWN buttons to highlight selections in the menu lists and press the Select button to select them. To exit a menu, press the **FM Presets/Menu** button. If you don't make a selection within 10 seconds the Stratus 7 will exit the **Menu Options** screen and revert to the last active display mode. You can exit any Menu Options screen by repeatedly pressing the **FM Presets/Menu** button.

Menu Options

Sirius ID

This displays your Stratus 7's 12-digit Sirius ID (SID) number.



```
Sirius ID  
12345678912
```

The SID is unique to each Stratus 7 Radio, and is required to activate your service. We recommend that you write this number in the space provided near the end of this User Guide. No adjustments are allowed in this mode. To exit, press the **FM Presets/Menu** button or the **Select** button.

Menu Options

FM Transmitter

The FM Transmitter menu option allows you to enable or disable the Stratus 7's built-in FM transmitter, and select up to 5 different preset FM transmitter frequencies.

```
FM Transmitter
>FM Presets
  FM On/Off
```

FM Presets

You can select from the 5 preset FM transmitter frequencies:

1. On the **FM Transmitter** screen, highlight and select **FM Presets**. The **FM Presets** screen will appear.

```
FM Presets
>FM1 88.1 MHz
  FM2 <EMPTY>
```

```
FM Frequency
  88.1 MHz
```

2. Use the Channel UP/DOWN buttons to highlight the FM preset you want (FM1 - FM5), and press the **Select** button. The FM Frequency screen will appear, showing the currently-selected frequency for that preset.
3. To select the FM Preset: Press the **Select** button. To change the FM Preset's FM frequency: Use the Channel UP/DOWN buttons to change the FM frequency, then press the **Select** button.

To exit, press the **FM Presets/Menu** button 3 times.

Menu Options

FM On/Off

You can turn the Stratus 7's FM transmitter ON and OFF:

1. From the FM Transmitter screen, highlight and select **FM On/Off**. The **FM On/Off** screen will appear.

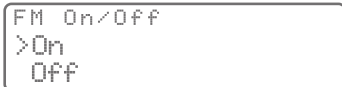

2. To turn the FM transmitter ON, highlight and select **On**; to turn the FM transmitter OFF, highlight and select **Off**.

To exit, press the **FM Presets/Menu** button twice.

Menu Options

Settings

The **Settings** menu lets you access the **Display Options**, **Audio Level**, **Tones**, **Clock**, **Jump Settings** and **Channel Lock** menu options.

```
Settines  
>Display Options  
  Audio Level
```

Display Options

The **Display Options** menu lets you adjust the Stratus 7's LCD display to improve its visibility in different lighting conditions, and to display different types of information.

```
Display Options  
>Brightness  
  Contrast
```

Menu Options

Brightness and Contrast

Brightness adjusts the overall intensity of the LCD display to help with viewing in different lighting conditions. Contrast adjusts the relationship between the background and the text on the LCD display.

Use the Channel UP/DOWN buttons to adjust the brightness and contrast. The bar graphs will indicate the change.



Mode

The **Mode** screen lets you change the **Default** display screen to display either the channel name, category name, or the time. Use the Channel UP/DOWN buttons to select the desired mode and press the Select button to set your choice.

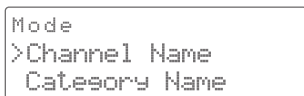

Channel Name



Category Name

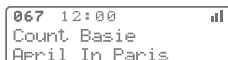

Time

Menu Options

Audio Level

The **Audio Level** screen lets you use the Channel UP/DOWN buttons to adjust the Stratus 7's audio output level. The bar graph will indicate the change.



Tones

You can select whether to hear an audible confirmation tone as you navigate menus and lists. To turn the tones ON or OFF, use the Channel UP/DOWN buttons to select your choice and press the **Select** button to set your choice.



Menu Options

Clock

The **Clock** screen allows you to setup the clock that appears on the **Default** screen, based on the format desired and the time zone in which you reside. The actual time is provided via the SiriusXM satellite signal, and will automatically update your Stratus 7.

```
Clock
>Format
  Time Zone
```

Format

Displays the time in either 12-hour (default) or 24-hour format.

```
Format
>12 Hour
  24 Hour
```

Time Zone

Since the clock adjusts the time automatically, it is important to specify your time zone. Select your time zone from the list of the available time zones.

```
Time Zone
>Eastern
  Atlantic
```

Menu Options

Daylight Savings Time

Select **On** if your area observes Daylight Savings Time; select **Off** if your area does not.

```
DST Observed  
>Yes  
No
```

Menu Options

Channel Lock

Your Stratus 7 has the ability to lock channels you do not want others (such as children) to access without your permission. Locked channels will not appear on the Channel List screen, or when browsing channels with the Channel UP/DOWN buttons. When the anyone tries to access a locked channel using the Direct Tuning function (see page 53), an **Enter Code** screen will be displayed and the channel won't be accessed until the correct code is entered.

Locking and Unlocking Channels

1. Select the **Channel Lock** menu option. The **Channel Lock** screen will appear.

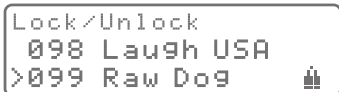

2. Select Lock/Unlock. You will need to enter a lock code to proceed. Refer to Setting the Lock/Unlock Code on the next page for information on how to set the lock code.
3. Once you enter the lock code the **Lock/Unlock** screen will appear. Use the Channel UP/DOWN buttons to highlight the channel you wish to lock or unlock from the channel list. Pressing the **Select** button will either add a padlock icon next to the channel name to indicate that the channel will be locked, or unlock a locked channel by removing the padlock icon.

Menu Options

Setting the Lock/Unlock Code

To set the lock code:

1. Select the **Channel Lock** menu option. The **Channel Lock** screen will appear.
2. Select the **Edit Code** menu option. The **New Code** screen will be displayed. Enter a four-digit code using the **0 - 9** number buttons. You will then be prompted to enter the new code again to confirm.

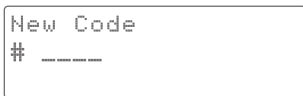

A screenshot of a screen titled "New Code". Below the title, there is a prompt "# ----" indicating where to enter a four-digit code.

3. When the lock code is confirmed, the lock code is set.

You can use this same procedure to change the lock code after you have set it.

Note: If you have forgotten your Channel Lock code, call Customer Service for help.

Menu Options

Signal

When using the optional Home Docking Station or boombox indoors, it is important to aim the antenna for maximum signal reception. The Signal screen visually shows the strength of the satellite and terrestrial signals being received by the Stratus 7. (Refer to the installation guide for more information about properly orienting the antenna.)



The SAT bar graph indicates the strength of the satellite signal strength; the TER bar graph indicates the strength of the terrestrial signal strength (if available).

Factory Default

The Factory Default menu option will restore most every feature of the radio to the original factory settings. The following is a list of all features affected by the Factory Default option:

- All Channel Presets are cleared
- Radio set to Normal Tuning Mode
- Display brightness set to 50%
- Display Contrast set to 50%
- FM Transmitter set to ON
- FM Transmitter Preset #1 set to 88.1 MHz
- Jump setting is cleared
- Top line display mode set to Channel Name
- Audio level set to -3dB
- Confirmation Tone set to ON

Menu Options

Note that the Parental Control feature is not affected by the Factory Default option. This prevents someone from circumventing the Channel Lock feature. Channels that have been locked will remain locked.

To activate the Factory Default feature, and restore the above features to their factory defaults, do the following:

1. Highlight and select **Factory Default** from the Menu Options screen. The **Restore?** screen will appear.

```
Restore?  
  Yes  
>No
```

```
Are You Sure?  
  Yes  
>No
```

2. Highlight and select **Yes** to restore the above settings to the their factory default settings, or select **No** to leave them as-is and return to the **Menu Options** screen.
3. If you select **Yes**, a confirmation screen appears. Use the Channel UP/DOWN buttons to select **Yes** to restore all settings to the settings from the factory, or select **No** to leave them as-is and return to the **Menu Options** menu.

```
Restoring
```

4. If you select **Yes**, the Stratus 7 will restore the original factory settings.
5. When the Restore is complete, the Stratus 7 will tune to the last channel that was active before the Factory Default was begun.

Troubleshooting

Symptom	Solution
The Stratus 7 does not power ON	<p>Blown fuse, or the power cable is not properly connected.</p> <ul style="list-style-type: none">• Check for a bad fuse and check power cable connection
Display reads: No Antenna	<p>The satellite antenna is not connected to the radio.</p> <ul style="list-style-type: none">• Check the satellite antenna connection to the radio.
Display reads: Acquiring Signal	<p>No satellite signal is being received.</p> <ul style="list-style-type: none">• Check for obstacles over or around the satellite antenna.• Change the vehicle location to eliminate nearby obstacles (bridges, overpasses, tress, buildings, etc.).
Audio static or loss of clarity	<p>The FM frequency contains static.</p> <ul style="list-style-type: none">• Locate a quiet FM frequency on your vehicle radio and set the FM transmitter frequency of the Stratus 7 Radio to match.• If using the <i>PowerConnect</i> Vehicle Dock AUDIO OUT connector, check the cable connections.
No sound	<p>The audio cables are not connected, or the FM radio is set to the wrong frequency.</p> <ul style="list-style-type: none">• Check the audio cables at the Stratus 7 Radio and the vehicle's audio system.• Tune the vehicle's FM radio to the same FM frequency the Stratus 7 Radio's FM transmitter is tuned.

Specifications

System

Power Requirements:	9-16 V DC, 500 mA (max)
Operating Temperature:	-4°F to +140°F (-20°C to +60°C)
Audio Output:	1.0 V _{rms} (max)

Stratus 7 Radio

Dimensions:	4.5 in (width) x 1.9 in (height) x 0.7 in (depth) 115 mm (width) x 48 mm (height) x 17 mm (depth)
Weight:	2.3 oz (66 g)

PowerConnect Vehicle Dock

Dimensions:	4.1 in (width) x 1.8 in (height) x 1.1 in (depth) 105 mm (width) x 46 mm (height) x 28 mm (depth)
Weight (without adapter):	1.4 oz (40 g)
Audio Connector:	1/8 in (3.5 mm) female
Antenna Connector:	SMB male

PowerConnect Power Adapter

Dimensions:	3.7 in (width) x 1.7 in (height) x 1.3 in (depth) 94 mm (width) x 43 mm (height) x 34 mm (depth)
Weight:	2.4 oz (69 g)
Input / Output:	9-16 V DC / 5 V DC, 1.5 A
Cable Length:	Approximately 4 ft 7 in (1.4 m)

Vehicle Antenna

Type:	SiriusXM Magnetic Mount
Connector:	SMB female, right angle
Cable Length:	Approximately 23 ft (7.0 m)

Aux In Cable

Connectors:	1/8 in (3.5 mm) stereo male to 1/8 in (3.5 mm) stereo male
Cable Length:	Approximately 4 ft (1.2 m)

Note: Features and Specifications are subject to change without notice.

IC Statement



Warning

Changes or modifications not expressly approved by the manufacturer could void the user's authority to operate the equipment.

Canadian Compliance

This Class B digital apparatus complies with Canadian ICES-003.

IC STATEMENT

Operation is subject to the following two conditions: (1) this device may not cause interference, and (2) this device must accept any interference, including interference that may cause undesired operation of the device. For product available in the Canada market, only channel 1~11 can be operated. Selection of other channels is not possible. This device and its antenna(s) must not be co-located or operation in conjunction with any other antenna or transmitter. To reduce potential radio interference to other users, the antenna type and its gain should be so chosen that the equivalent isotropically radiated power (e.i.r.p) is not more than that permitted for successful communication. IC Radiation Exposure Statement: This equipment complies with IC RSS-102 radiation exposure limits set forth for an uncontrolled environment. This equipment should be installed and operated with minimum distance 20cm between the radiator & your body.

Copyrights and Trademarks

© 2015 Sirius XM Canada Inc. "SiriusXM", the SiriusXM logo, channel names and logos are trademarks of Sirius XM Radio Inc. and are used under license. "NFL" and the NFL Shield design are trademarks of the National Football League. NASCAR® is a registered trademark of the National Association for Stock Car Auto Racing, Inc. The NBA and NBA member team identifications are the intellectual property of NBA Properties, Inc. and the respective NBA member teams. © 2015 NBA Properties, Inc. All rights reserved. NHL and the NHL Shield are registered trademarks of the National Hockey League. © NHL 2015. Elvis Radio logo © EPE Reg. U.S. Pat & TM off. CFL® is a registered trademark of the Canadian Football League. All other trademarks, service marks, images and logos are property of their respective owners and are used with permission. All Rights Reserved. Required subscription sold separately. Premier subscription required for some channels. Prices and programming is subject to change. See Customer Agreement for complete terms at siriusxm.ca.

Sirius ID

Write down the Sirius ID (SID) of your Stratus 7 in the space provided below.

SID: _____

www.siriusxm.ca

**Sirius XM Canada Inc.
135 Liberty St. - 4th floor
Toronto, Ontario, M6K 1A7**

1-888-539-SIRIUS (7474)

© 2015 Sirius XM Canada Inc.

Stratus 7 User Guide 150105a