



## **User Guide**

**TTR1C Tabletop Internet Radio**



# Table of Contents

|  |           |   |           |
|--|-----------|---|-----------|
| <b>Introduction</b> . . . . .          | <b>5</b>  | <b>Appendix: Manual Network Configuration</b> . . . . . | <b>65</b> |
| Features . . . . .                     | 6         | <b>Troubleshooting</b> . . . . .                        | <b>75</b> |
| Safety and Care Information . . . . .  | 7         | <b>Product Specifications</b> . . . . .                 | <b>81</b> |
| What's in the Box? . . . . .           | 9         | Patent Information . . . . .                            | 83        |
| SIRIUS TTR1C Internet Radio            |           | Environmental Information . . . . .                     | 83        |
| Functions . . . . .                    | 10        |   |           |
| Remote Control . . . . .               | 12        |   |           |
| Display Screen . . . . .               | 13        |   |           |
| <b>Installation</b> . . . . .          | <b>15</b> |   |           |
| Introduction . . . . .                 | 16        |   |           |
| Step 1: Connect to a Network . . . . . | 17        |   |           |
| Step 2: Enter Your SIRIUS Account      |           |   |           |
| Information . . . . .                  | 23        |   |           |
| <b>Using Your SIRIUS TTR1C Radio</b> . | <b>25</b> |   |           |
| Navigation Basics . . . . .            | 26        |   |           |
| Direct Tune . . . . .                  | 30        |   |           |
| Favourite Channels . . . . .           | 31        |   |           |
| Alarm Clock . . . . .                  | 32        |   |           |
| Snooze . . . . .                       | 34        |   |           |
| Sleep Timer . . . . .                  | 35        |   |           |
| Parental Control . . . . .             | 36        |   |           |
| Audio Settings . . . . .               | 42        |   |           |
| <b>Configuring Your SIRIUS TTR1C</b>   |           |   |           |
| <b>Radio</b> . . . . .                 | <b>45</b> |   |           |
| SIRIUS setup . . . . .                 | 46        |   |           |
| System Setup . . . . .                 | 50        |   |           |





# Introduction

## Features

### **Congratulations, on your purchase of the SIRIUS TTR1C Internet Radio!**

Your new SIRIUS TTR1C Internet Radio comes with everything you need to enjoy SIRIUS Internet Radio in your home.

Use this manual to familiarize yourself with all of your SIRIUS TTR1C Internet Radio features and capabilities. For the latest information about your SIRIUS TTR1C Internet Radio and other SIRIUS products and accessories, visit <http://www.sirius.ca>.

**Please read the entire User Guide before using your SIRIUS TTR1C Internet Radio!**

## Safety and Care Information



**IMPORTANT!** Always read and understand all the instructions to avoid injury to yourself and/or damage to your device. Sirius Canada Inc. disclaims all responsibility for damage from data loss due to breakdown, repair, or other causes.

- Do not expose to extreme temperatures (above 140°F or below -4°F, or above 60°C or below -20°C).
- Do not expose to moisture. Do not use device near or in water.
- Do not let any foreign matter spill into device.
- Do not store in dusty areas.
- Do not expose to chemicals such as benzene and thinners. Do not use liquid or aerosol cleaners. Clean with a soft damp cloth only.
- Do not expose to direct sunlight for a prolonged period of time, and do not expose to fire, flame, or other heat sources.
- Do not try to disassemble and/or repair device yourself.
- Do not drop your device or subject it to severe impact.
- Do not place heavy objects on device.
- Do not subject device to excessive pressure.
- If the screen is damaged, do not touch the liquid crystal fluid.

### WARNING!

- Opening the case may result in electric shock.
- Make sure that you insert the plug all the way into the outlet.
- Do not touch the device with wet hands.
- Do not install near any heat sources such as radiators, heat registers,

# Introduction

- stoves, or other apparatus (including amplifiers) that produce heat.
- Do not defeat the safety purpose of the polarized or grounding type plug. A polarized plug has two blades with one wider than the other. A grounding type plug has two blades and a third grounding prong. The wide blade or the third prong is provided for your safety. When the provided plug does not fit into your outlet, consult an electrician for replacement of the obsolete outlet.
  - Protect the power cord from being walked on or pinched particularly at plugs, convenience receptacles, and the point where they exit from the apparatus.



**CAUTION:** TO REDUCE THE RISK OF ELECTRIC SHOCK, DO NOT REMOVE COVER (OR BACK). NO USER-SERVICEABLE PARTS INSIDE. REFER SERVICING TO QUALIFIED SERVICE PERSONNEL.



When found on the apparatus, the lightning flash with arrowhead symbol indicates hazards arising from dangerous voltages.



When found on the apparatus, the exclamation point within an equilateral triangle symbol indicates the user should read all safety statements found in the user's manual.



When found on the apparatus, the double box symbol indicates double insulation.

---

## WARNING

TO REDUCE THE RISK OF FIRE OR ELECTRIC SHOCK, DO NOT EXPOSE THIS APPARATUS TO RAIN OR MOISTURE.

---



## What's in the Box?

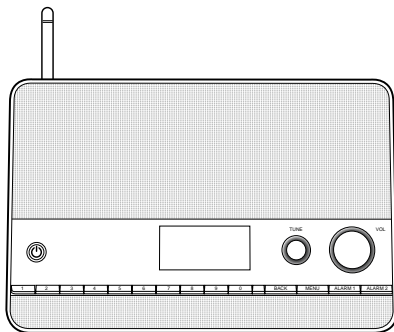

SIRIUS TTR1C Internet Radio

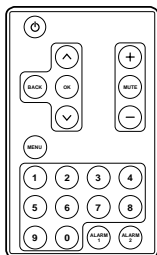

Remote Control

# Introduction

## SIRIUS TTR1C Internet Radio Functions

**Power Button** (page 26)  
Turn radio On and Off.

**TUNE Knob (Multifunction)** (page 26)  
Turning the knob at the default display screen displays the category tune screen; pressing the knob at the default display screen displays the direct tune screen; turning the knob in a menu or user input screen scrolls through menus and choices; pressing the knob in a menu or user input screen selects a highlighted item; pressing and holding displays the **Parental control** menu.

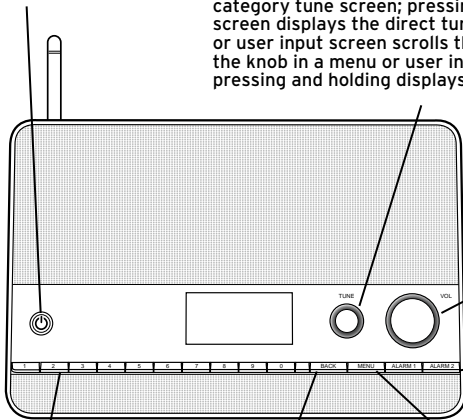

**VOL (Volume) Knob** (page 26)  
Increases or decreases volume; also mutes the audio.

**ALARM 1 / ALARM 2 Buttons** (page 27)  
Turns the alarm clocks On or Off; pressing and holding displays the alarm settings.

**0-9 Number Buttons** (page 26)  
Set and select channel presets or directly enter channel numbers.

**BACK Button** (page 27)  
Press to return to the previous display screen.

**MENU Button** (page 27)  
Press to access or exit category and channel tuning, advanced features, and configuration options.

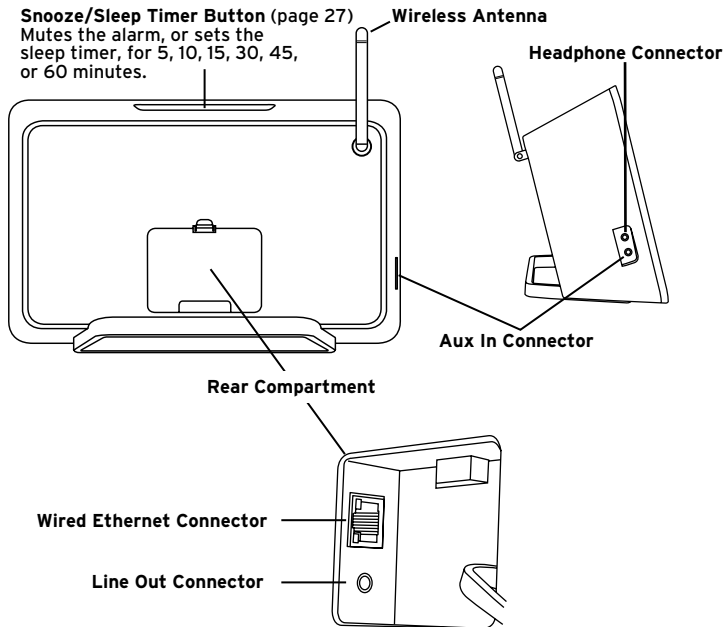

# Introduction

## Remote Control

### Power Button

Turn radio On and Off.

### OK Button

Press to select channel list and menu items.

### BACK Button

Press to return back to the previous display screen.

### MENU Button

Press to access or exit advanced features and configuration options.

### 0-9 Number Buttons

Set and select channel presets or directly enter channel numbers.

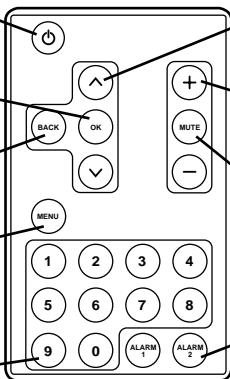

### Arrow Buttons

Press to scroll through lists; also highlight menu options.

### +/- Buttons

Press to increase or decrease the audio volume.

### MUTE

Press to silence the audio.

### ALARM 1 / ALARM 2

Press to turn the respective alarm clock On or Off; pressing and holding displays the alarm settings.

## Display Screen

When using the SIRIUS TTR1C Internet Radio, information about songs and artists, and radio functions are displayed.

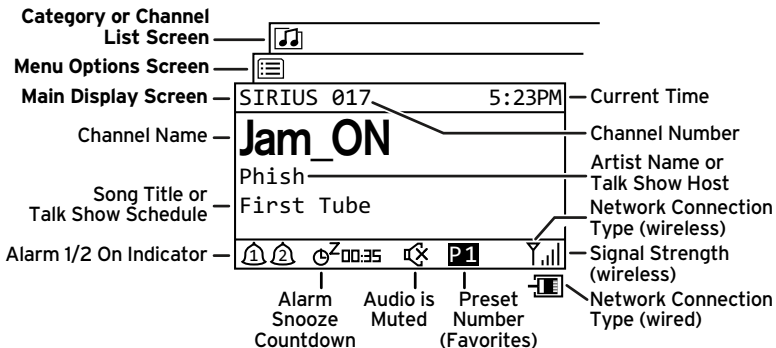





# Installation

## Introduction

The SIRIUS TTR1C Internet Radio allows you to listen to all of the channels on your Premium SIRIUS Internet Radio subscription package using either a wireless Internet connection (Wi-Fi), or using a wired Ethernet connection.

You must be subscribed to the SIRIUS Satellite Radio service to use the SIRIUS TTR1C Internet Radio. Go to [www.sirius.ca](http://www.sirius.ca) or call 1-888-539-7474 to subscribe and get your user name and password.

The SIRIUS TTR1C Internet Radio supports a wireless Internet connection through any standard 802.11b/g access point. This includes wireless networks which are WEP/WPA/WPA2 protected and require a password, and wireless networks where the network name (SSID) is hidden. Once you have connected to a wireless network, the radio will remember your network settings so you will not have to enter the information again, unless you perform a reset of the radio to the factory defaults.



## Step 1: Connect to a Network

The Network Wizard feature is the easiest way to connect to a wireless network. It searches for available wireless networks and displays a list of wireless networks found for you to select. However, if your wireless network name (SSID) is hidden, or if your network is DHCP disabled, you'll have to manually enter the network settings rather than using the Network Wizard.

Decide whether you will be using a wireless network connection, or a wired network connection, and whether you can use the Network Wizard or if you'll need to manually configure your network settings. Complete the instructions in the appropriate section:

Connect to a WIRELESS network using the NETWORK WIZARD (page 17)

Connect to a WIRED network using the NETWORK WIZARD (page 21)

Connect to a WIRELESS network using MANUAL settings (page 66)

Connect to a WIRED network using MANUAL settings (page 71)

# Installation

## To connect to a wireless network using the Network Wizard

If the wireless network is secured, you'll need to enter the key (password) for the wireless network during the connection procedure. If you don't know the password, contact your network administrator or the person who setup the wireless network.

- a. If you have just turned your SIRIUS TTRIC Internet Radio on for the first time, the **SSID** screen will already be displayed. Skip ahead to step e.
- b. Press **MENU** and turn the **TUNE knob** to highlight **System Setup**. Press the **TUNE Knob**.
- c. Turn the **TUNE knob** to highlight **Network**. Press the **TUNE Knob**.
- d. Press the **TUNE Knob** to select **Network Wizard**.
- e. The radio will scan for wireless networks and return with a list of wireless networks which were found. (A sample screen is shown here. Your actual wireless network name will appear in the list, if found.) Turn the **TUNE knob** to highlight your wireless network and press the **TUNE knob**. If you don't know the network name, contact your network administrator of the person who set up the wireless network.
- f. If you choose an unsecured network, and the radio is able to connect to the wireless network, the **Connected** screen will be

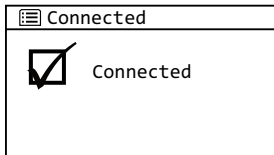
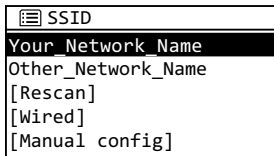

displayed and the radio will connect to the wireless network. Skip to step **h**.

If you choose a network that is secured, you will be prompted to enter the key (password). If you don't know the password, contact your network administrator of the person who setup the wireless

network. Remember that the key is case sensitive. Turn the **TUNE knob** to scroll through the list of characters and highlight each character. Press the **TUNE knob** to select the highlighted character and move to the next character. If you make a mistake, press **BACK**, or turn the **TUNE knob** to highlight **BKSP** and press the **TUNE knob** to erase the character.

- g.** When the key has been entered, turn the **TUNE knob** to scroll to highlight **OK** and press the **TUNE knob**. If you have entered the correct key, and the radio is able to connect to your wireless network, the **Connected** screen will be displayed. If you have entered the wrong key, the **Incorrect key** screen is displayed, and you will be prompted to enter the key again.
- h.** If you are installing your SIRIUS TTRIC Internet Radio for the first time, continue with "Step 2: Enter Your SIRIUS Account Information" on page 23.

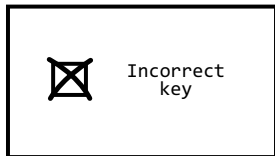
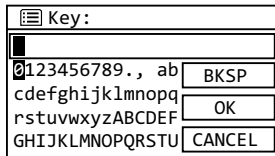

# Installation

If you have previously entered your SIRIUS user name and key into the radio, and had tuned to a channel, the screen will show **Connecting**. When successfully connected, the **Buffering...** screen will be displayed as the channel information is streamed to the radio. When complete, you are returned to the main display screen and you should hear the audio playing. Otherwise, the **Category Tune** screen is displayed.

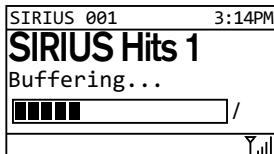
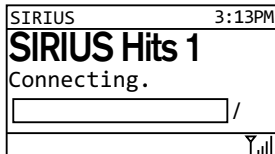

## To connect to a wired network using the Network Wizard:

- a. At the rear of the radio, remove the compartment cover and connect an Ethernet cable to the Ethernet connector on the inside left of the compartment. Refer to “Wired Ethernet Connector” on page 11 for the location of the Ethernet connector. Replace the compartment cover.
- b. Connect the other end of the Ethernet cable to your home’s wired network.
- c. If you have turned your SIRIUS TTRIC Internet Radio on for the first time, the SSID screen will already be displayed. Skip ahead to step g.
- d. Press **MENU** and turn the **TUNE knob** to highlight **System Setup**. Press the **TUNE Knob**.
- e. Turn the **TUNE knob** to highlight **Network**. Press the **TUNE Knob**.
- f. Press the **TUNE Knob** to select **Network Wizard**.
- g. The radio will scan for networks. When the scan is complete, turn the **TUNE knob** to highlight **[Wired]** and press the **TUNE knob**.
- h. If the radio is able to connect to your network, the **Connected** screen will be displayed. If **Waiting for Ethernet**

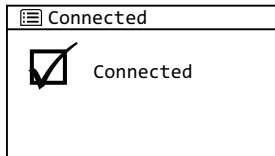
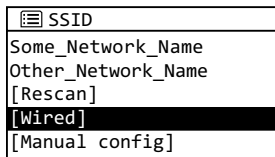

# Installation

is displayed, check the Ethernet cable connections.

- i. If you are installing your SIRIUS TTR1C Internet Radio for the first time, continue with "Step 2: Enter Your SIRIUS Account Information" on page 23.

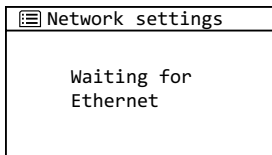

If you have previously entered your SIRIUS user name and key into the radio, and had tuned to a channel, the screen will show **Connecting**. When successfully connected, the **Buffering...** screen will be displayed as the channel information is streamed to the radio. When complete, you are returned to the main display screen and you should hear the audio playing. Otherwise, the **Category Tune** screen is displayed.

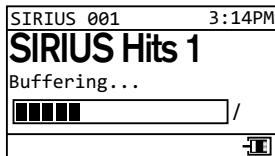
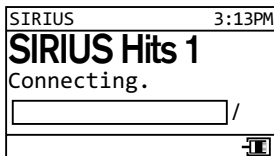

## Step 2: Enter Your SIRIUS Account Information

The SIRIUS TTR1C Internet Radio needs your account user name and password to connect to SIRIUS Internet Radio service. If are not yet subscribed to the SIRIUS Satellite Radio service, go to [www.sirius.ca](http://www.sirius.ca) or call 1-888-539-7474 to subscribe, and get your user name and password. If you are a current SIRIUS subscriber but do not have an online user name or password, please contact, Customer Care at 1-888-539-SIRIUS (7474).

### *To enter your account information:*

- a. Turn on the radio by pressing the **Power button**.
- b. Press **MENU** and turn the **TUNE knob** to highlight **SIRIUS Setup**. Press the **TUNE knob**.
- c. Turn the **TUNE knob** to highlight **User name**. Press the **TUNE knob**.
- d. Turn the **TUNE knob** to scroll through the list of characters and highlight each character for your user name. Press the **TUNE knob** to select the highlighted character and move to the next character. If you make a mistake, press **BACK**, or turn the **TUNE knob** to highlight **BKSP** and press the **TUNE knob** to erase the character.

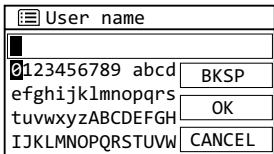
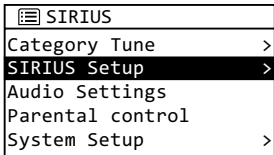

# Installation

- e. When you have entered your user name, turn the **TUNE knob** to scroll to highlight **OK** and press the **TUNE knob**.
- f. You will then be prompted to enter your password. Enter your password in the same way as you entered your user name and then select **OK**. Note that the password is case sensitive.
- g. The radio will attempt to connect to the SIRIUS Internet Radio service. If the user name and password you entered is incorrect, the **Login failed** screen will be displayed. You'll have to re-enter the correct user name and password.

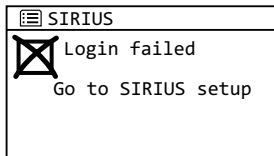

If you have previously connected to a network, and had tuned to a channel, the screen will show **Connecting**. When successfully connected, the **Buffering...** screen will be displayed as the channel information is streamed to the radio. When complete, you are returned to the main display screen and you should hear the audio playing. Otherwise, the **Category Tune** screen is displayed.

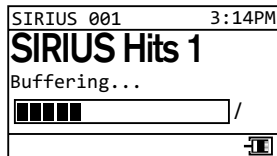
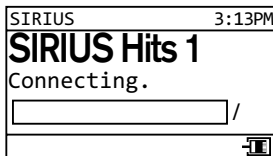



# Using Your SIRIUS TTR1C Radio

# Using Your SIRIUS TTR1C Radio

## Navigation Basics

### Power Button

The **Power button** turns the SIRIUS TTR1C Internet Radio On or Off.



### Tune Knob

The **TUNE knob** is multifunction– you can turn it clockwise or counter-clockwise, and press it.



- **Turn:** Turning the **TUNE knob** when at the main display screen displays the **Category tune** screen. When in menus or user input screens, turning the **TUNE knob** scrolls up or down through menus and user choices.
- **Press and Release:** Pressing the **TUNE knob** at the default display screen displays the **Direct tune** screen. When in menus or user input screens, pressing the **TUNE knob** selects a highlighted item.
- **Press and Hold:** pressing and holding the **TUNE knob** displays the **Parental control** menu options.

### VOL Knob

Turning the **VOL knob** clockwise or counter-clockwise increases or decreases the volume of the audio. When turned counter-clockwise it will mute the audio when zero is reached.



### Number Buttons 0-9



The number buttons are used to store favourite channels in a button location so you can tune a channel just by pressing the button. They can also be used to enter the channel number when at the **Direct tune** screen.

## BACK Button



The **BACK** button returns back to the previously displayed screen.

## MENU Button



Pressing the **MENU** button from the main display screen accesses the advanced features and configuration options menu, where you can browse the channel categories and channels, and change the radio settings. Pressing it when in the configuration options menu returns the radio to the main display screen.

## ALARM 1 / ALARM 2 Buttons



Pressing the **ALARM** button turns the respective alarm clock function On or Off. Pressing and holding the **ALARM** button displays the respective alarm setup screen where you can configure the options for each alarm.

## Snooze / Sleep Button

When the alarm clock is sounding, pressing the **Snooze/Sleep** button will silence the alarm for 5 minutes. Each additional immediate press of the **Snooze/Sleep** button increases the snooze time for 10, 15, 30, 45 or 60 minutes. While snoozing, the snooze countdown time is displayed on the display screen.

While the radio is playing, pressing the **Snooze/Sleep** button enters the sleep mode. The first press displays **Sleep OFF**, and each immediate additional press sets the sleep time for 5, 10, 15, 30, 45 or 60 minutes.

While in snooze or sleep mode, the countdown time is displayed on the display screen. You can also check and change the remaining snooze/sleep time by pressing the **Snooze/Sleep** button. To increase the sleep or snooze time, repeatedly press the **Snooze/Sleep** button until the desired sleep/snooze time is displayed.

# Using Your SIRIUS TTR1C Radio

## Listening to SIRIUS Internet Radio

### Tune a Channel:

1. Press **MENU**.
2. Press the **TUNE knob** to select **Category Tune**.
3. Press the **TUNE knob** to select **All Channels** to browse through all the channels, or turn the **TUNE knob** to highlight a category. Press the **TUNE knob** to select the category.
4. Turn the **TUNE knob** browse through the channels, and highlight a channel to tune. Press the **TUNE knob** to tune the channel. The radio will momentarily tune the channel.

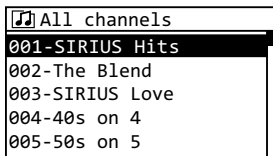

**TIP!** Go to [www.sirius.ca](http://www.sirius.ca) to view our complete channel lineup.

### View a Category:

Channels are organized into categories to make it easier for you to find the ones that suit your taste.

1. To view the categories press **MENU**.

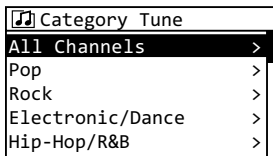

2. Press the **TUNE knob** to select **Category Tune**.
3. Turn the **TUNE knob** to browse through and highlight a category.
4. Press the **TUNE knob** to select the category and view the channels in the category.

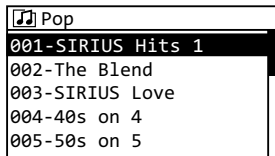

## Returning to Main Display Screen

When in the advanced features and configuration options menu, pressing **MENU** will return you to the main display screen.

# Using Your SIRIUS TTR1C Radio

## Direct Tune

A channel can be tuned directly by entering the channel number.

1. From the main display screen, press the **TUNE** button.
2. Use the **0-9** number buttons on the radio or Remote Control to enter the channel number. If you make a mistake, press **BACK**, or turn the **TUNE knob** to highlight **BKSP** and press the **TUNE knob** erase the character.
3. When the channel number is entered, turn the **TUNE knob** to highlight **OK**. Press the **TUNE knob** to tune the channel.

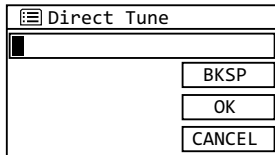

## Favourite Channels

You can assign up to 10 of your favourite channels to a number button (0-9) so you can easily tune them.

### *To assign a favourite channel to a number button:*

1. Tune to the channel you want as a favourite.
2. Press and hold a number button (0-9) for one second to assign the channel as a favourite (preset) to that button.



**IMPORTANT!** If the button you choose already has a favourite channel assigned to it, it will be replaced with the new favourite channel.

### *To tune a favourite channel:*

1. Press the number button 0-9 that is assigned to the favourite channel. The channel will momentarily be tuned.

# Using Your SIRIUS TTR1C Radio



## Alarm Clock

Your SIRIUS TTR1C Internet Radio has two alarm clocks which can be configured according to your liking. When the radio is off, and the alarm(s) are on, the times of each alarm are displayed on the screen.

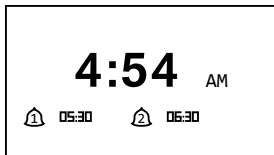
Before you configure the alarm clock, refer to “Clock Setup” on page 53 and ensure that the Time Zone and Daylight Savings Time are set correctly.



### To turn the alarm clocks On or Off:

1. Press the **ALARM 1** or **ALARM 2** button to toggle the alarms On or Off. If the alarm(s) are On, the alarm icon(s)   will be displayed in the lower left of the main display screen.

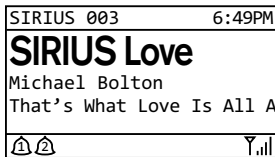

### To configure an alarm clock:

1. Press **MENU**. You can also press and hold the alarm button that you want to configure to go directly to the alarm configuration (go to step 4).
2. Turn the **TUNE knob** to scroll to and highlight **System Setup**. Press the **TUNE knob**.
3. Turn the **TUNE knob** to scroll to and highlight **Alarms**. Press the **TUNE knob**.

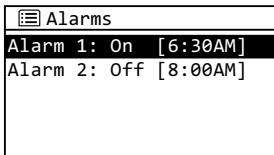



- The Alarms screen summarizes each alarm clock setting. To configure an alarm, turn the **TUNE knob** to scroll to and highlight **Alarm 1** or **Alarm 2**. Press the **TUNE knob**.
- Each alarm has 5 configuration options which are summarized in the following table at the beginning of this section. To change an option, turn the **TUNE knob** to scroll to and highlight the option. Press the **TUNE knob** to configure the option.

|                       |
|-----------------------|
| ☰ Alarm 1             |
| <b>Enable: Daily</b>  |
| Time: 6:30AM          |
| Wake to: SIRIUS       |
| Preset: Last Listened |
| Volume: 5             |

|         |  |
|---------|--|
| Enable  | Off<br>Daily<br>Once<br>Weekends<br>Weekdays                         |
| Time    | 12:00 AM - 11:59 PM  |
| Wake to | SIRIUS<br>Buzzer   |
| Preset  | Last listened (last channel tuned)<br>Any favourite channel (1 - 10) |
| Volume  | 1 - 20   |

- Turn the **TUNE knob** to scroll to and highlight a setting for each option. Press the **TUNE knob** to select the setting. Continue until you have configured all the options for the alarm.
- When you are done, press **Alarm 1** or **Alarm 2**, or any button, to save the alarm setting.



Alarm  
Saved

# Using Your SIRIUS TTR1C Radio

## Snooze

When the alarm sounds, pressing the **Sleep/Snooze** button will silence the alarm for a period of time. After the snooze time elapses, the alarm will sound again.

### To snooze:

1. Press the **Snooze/Sleep** button on the top of the radio. The radio will display a snooze time of **05 minutes**.
2. Each immediate subsequent press of the **Snooze/Sleep** button increases the snooze time to 10, 15, 30, 45, or 60 minutes.
3. For the snoozing alarm, a countdown timer is displayed showing how many minutes are remaining before the alarm sounds again. The alarm icon will also blink for the snoozing alarm.
4. You can also check and change the remaining snooze time by pressing the **Snooze/Sleep** button. To increase the snooze time, repeatedly press the **Snooze/Sleep** button until the desired snooze time is displayed.

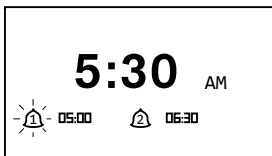
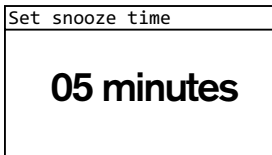

## Sleep Timer

The sleep timer turns the radio off after a period of time as you fall asleep. The time can be set to turn the radio off after 5, 10, 15, 30, 45, or 60 minutes.

### To turn the sleep timer On:

1. Press the **Snooze/Sleep** button on the top of the radio. The radio will display a sleep time of **05 minutes**.
2. Each subsequent press of the **Snooze/Sleep** button increases the sleep time to 10, 15, 30, 45, or 60 minutes.
3. A countdown timer is displayed at the bottom of the screen showing how many minutes are remaining before the radio turns off.
4. You can also check and change the remaining sleep time by pressing the **Snooze/Sleep** button. To increase the sleep time, repeatedly press the **Snooze/Sleep** button until the desired sleep time is displayed.

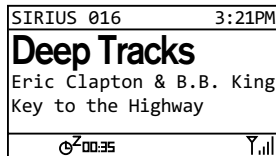
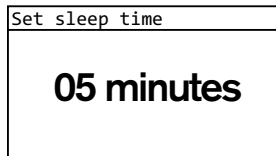

### To turn the sleep timer Off:

1. Repeatedly press the **Snooze/Sleep** button on the top of the radio until **Off** is displayed.

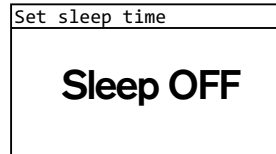

# Using Your SIRIUS TTR1C Radio

## Parental Control

Your SIRIUS TTR1C Internet Radio has a parental control feature which will allow you to lock access to channels. A 4-digit code controls access to the locked channel or locked category.

When you browse a category, the locked channel will have an L displayed to the right of the channel name.

If you attempt to tune to a locked channel, either by using direct tune or through the category list, you'll be prompted to enter your 4-digit code. When the correct code is entered, you'll be able to tune to the channel.

All locked channels become unlocked and will remain unlocked until you turn the radio Off, and back On.

If the radio is turned off while listening to a locked channel, the next time you turn the radio on, you will be prompted to enter your lock code. If you cancel, and do not enter your lock code, the channel will display Parental locked.

### *To change the parental lock code:*

The SIRIUS TTR1C Internet Radio has a default lock code of **1111**. The first time you change the lock code, you'll need to enter this code during the procedure.

1. Press **MENU**. You can also press and hold the **TUNE knob** to go directly to parental control (go to step 3).
2. Turn the **TUNE knob** to scroll to and highlight **Parental control**. Press the **TUNE knob**.

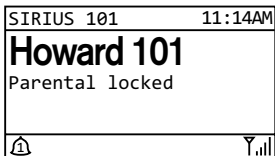
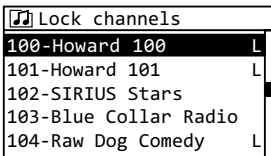

- Turn the **TUNE knob** to highlight **Change lock code**. Press the **TUNE knob**.
- You will be prompted to enter the original lock code. If this is the first time you are changing the lock code, enter 1111, otherwise enter your existing lock code. Use the **0-9** number buttons on the radio or Remote Control to enter the lock code. If you make a mistake, turn the **TUNE knob** to highlight **BKSP** and press the **TUNE knob** to erase the character. When you have selected all 4 digits of your code, turn the **TUNE knob** to highlight **OK** and press the **TUNE knob**.

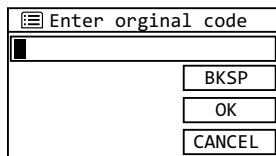

- You will be prompted to enter the new code. Enter the new code you desire in the same way. When you have selected all 4 digits of your code, turn the **TUNE knob** to highlight **OK** and press the **TUNE knob**.
- You will be prompted to enter the new code again. Enter the new code again in the same way. When you have selected all 4 digits of your code, turn the **TUNE knob** to highlight **OK** and press the **TUNE knob**.
- If you have entered your new code correctly, **New Code Saved** will be displayed.

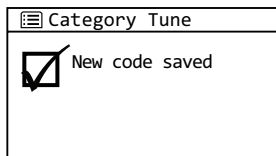

# Using Your SIRIUS TTR1C Radio

8. Press **MENU** to exit.

## *To turn Parental control Off:*

1. Press and hold the **TUNE knob**.
2. **Lock/Unlock** will be highlighted. Press the **TUNE knob**.
3. You will be prompted to enter your 4-digit lock code. Use the **0-9** number buttons on the radio or Remote Control to enter the lock code. If you make a mistake, turn the **TUNE knob** to highlight **BKSP** and press the **TUNE knob** to erase the character. When you have selected all 4 digits of your code, turn the **TUNE knob** to highlight **OK** and press the **TUNE knob**.
4. If you have entered the correct code, the parental lock is turned off. If you entered an incorrect code, **Parental lock code mismatch** message will be displayed, and the channels will remain locked.

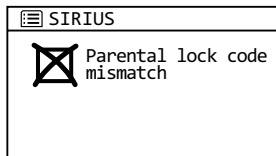
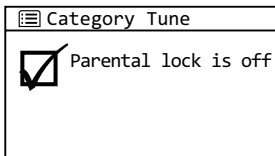
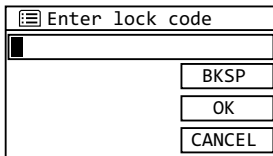

**To lock or unlock channels:**

1. Press and hold the **TUNE knob**.
2. Turn the **TUNE knob** to scroll through the list and highlight **Lock channels**. Press the **TUNE knob**.
3. If parental control is On (locked), you will be prompted to enter your 4-digit code, otherwise skip to step 4. Use the **0-9** number buttons on the radio or Remote Control to enter the lock code. If you make a mistake, turn the **TUNE knob** to highlight **BKSP** and press the **TUNE knob** to erase the character. When you have selected all 4 digits of your code, turn the **TUNE knob** to highlight **OK** and press the **TUNE knob**.

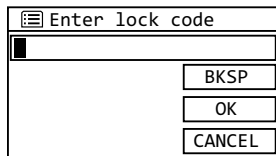

4. When you have successfully unlocked parental control, a list of all the channels will be displayed. Turn the **TUNE knob** to scroll through the list and highlight a channel that you wish to lock. Press the **TUNE knob** to lock the channel. An **L** will be displayed to the right of the channel name indicating that the channel is locked.

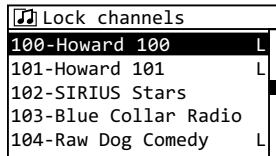

# Using Your SIRIUS TTR1C Radio

To unlock a channel, highlight a locked channel and press the **TUNE knob**. The **L** lock indicator will be removed indicating that the channel is unlocked.

5. Continue to lock or unlock channels until you are done. When complete, press **MENU**. You will be prompted to save the parental lock list. Turn the **TUNE knob** to highlight **YES** and press the **TUNE knob**.
6. A confirmation screen will be displayed. Press **MENU** to exit.

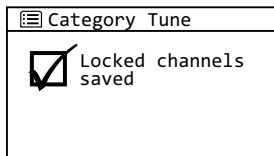
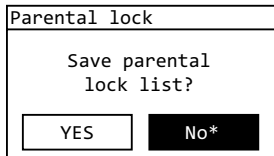

## *To listen to a locked channel:*

When you tune to a locked channel, the channel will display **Parental locked** and no audio will play until you have unlocked the channel.

1. Select the locked channel which will display **Parental locked**.
2. Press the **TUNE knob**.
3. Use the **0-9** number buttons on the radio or Remote Control to enter the lock code. If you make a mistake, turn the **TUNE knob** to highlight **BKSP** and press the **TUNE**

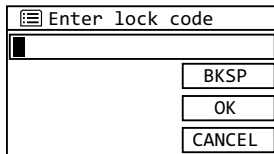



**knob** to erase the character. When you have selected all 4 digits of your code, turn the **TUNE knob** to highlight **OK** and press the **TUNE knob**.

4. If you have entered the correct lock code, the channel will begin playing.

Once you have unlocked one channel, all locked channels become unlocked and will remain unlocked until you turn the radio Off. The next time you turn the radio On, all channels will be locked.

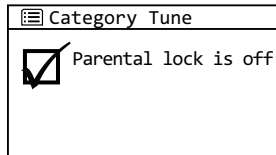

# Using Your SIRIUS TTR1C Radio

## Audio Settings

In the Audio Settings menu option, you can adjust the equalization profile of the radio (EQ) to adjust for room acoustics and your listening pleasure. The profiles for equalization are Flat, Loudness, Bass Boost, Bright, and Vocal Boost.

Another audio settings adjustment option is spatialization. Spatialization makes the radio sound like it is in a three-dimensional environment. By default, spatialization is on, but can be turned off.

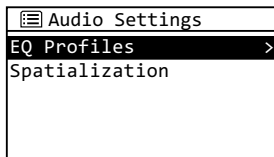

*To change the equalization profile:*

1. Press **MENU**.
2. Turn the **TUNE knob** to scroll to and highlight **Audio Settings**. Press the **TUNE knob**.
3. Press the **TUNE knob** to select **EQ Profiles**.
4. The currently selected profile will be denoted with an asterisk. Turn the **TUNE knob** to scroll to and highlight the equalization profile desired, and press the **TUNE knob**. The radio will change to the new equalization profile.
5. Press **MENU** to exit.

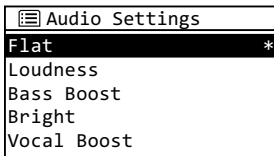

***To turn spatialization on or off:***

- 1.** Press **MENU**.
- 2.** Turn the **TUNE knob** to scroll to and highlight **Audio Settings**. Press the **TUNE knob**.
- 3.** Turn the **TUNE knob** to scroll to and highlight **Spatialization**. Press the **TUNE knob**.
- 4.** Turn the **TUNE knob** to highlight **ON** or **OFF** and press the **TUNE knob**.
- 5.** Press **MENU** to exit.

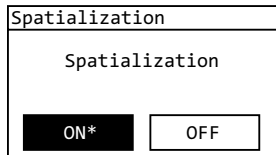



# Configuring Your SIRIUS TTR1C Radio

# Configuring Your SIRIUS TTR1C Radio

## SIRIUS setup

The **SIRIUS setup** menu option allows you to configure your user name and password for the SIRIUS Internet Radio service. You can also check the status of your connection.

If are not yet subscribed to the SIRIUS Satellite Radio service, go to [www.sirius.ca](http://www.sirius.ca) or call 1-888-539-7474 to subscribe, and get your user name and password.

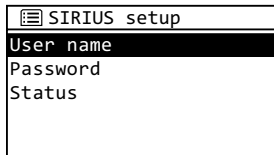

To test whether you are subscribed to the service, go to [www.sirius.ca](http://www.sirius.ca), click on the **LISTEN ONLINE** link, and then click the **LAUNCH PLAYER** link. Enter your username and password. Select a channel to listen to. Close the browser window to exit the player before continuing.

## User name and Password

This option allows you to enter your user name and password for the SIRIUS Internet Radio service. If for any reason your user name or password should change after you had entered the information into the radio, use these procedures to re-enter your user name and password.

*To enter your user name:*

1. Press **MENU**.

2. Turn the **TUNE knob** to scroll to and highlight **SIRIUS setup**. Press the **TUNE knob**.
3. **User name** will be highlighted. Press the **TUNE knob**.
4. Turn the **TUNE knob** to scroll through the list of characters and highlight each character for your user name. Press the **TUNE knob** to select the highlighted character and move to the next character. If you make a mistake, turn the **TUNE knob** to highlight **BKSP** and press the **TUNE knob** erase the character.

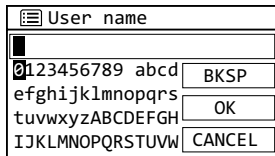

5. When you have entered your user name, turn the **TUNE knob** to scroll to highlight **OK** and press the **TUNE knob**.
6. You'll now be prompted to enter your password. Continue with the step 4 in next section, and enter your password.

***To enter your password:***

1. Press **MENU**.
2. Turn the **TUNE knob** to scroll to and highlight **SIRIUS setup**. Press the **TUNE knob**.
3. Turn the **TUNE knob** to scroll to and highlight **Password**. Press the **TUNE knob**.

# Configuring Your SIRIUS TTR1C Radio

4. Turn the **TUNE knob** to scroll through the list of characters and highlight each character for your password. The password is case sensitive. Press the **TUNE knob** to select the highlighted character and move to the next character. If you make a mistake, turn the **TUNE knob** to highlight **BKSP** and press the **TUNE knob** erase the character.

|                    |        |
|--------------------|--------|
| Password           |        |
| █                  |        |
| 0123456789 abcd    | BKSP   |
| efghijklmnopqrs    | OK     |
| tuvwxyzABCDEFGH    |        |
| IJKLMNOPQRSTUVWXYZ | CANCEL |

5. When you have entered your user name, turn the **TUNE knob** to scroll to highlight **OK** and press the **TUNE knob**.
6. The Saved screen will be displayed. If you have correctly entered the information, the radio will display the **Connecting...** and then the **Buffering...** screens. If your user name or password is incorrect, the **Login failed** screen will be displayed.

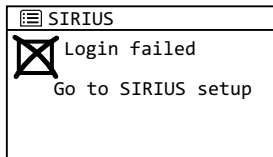
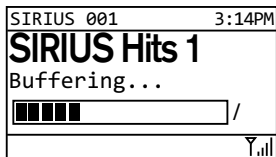



## Status

The **Status** screen shows the current status of your Premium SIRIUS Internet Radio service, the user name you are using, and the bit rate of your connection.

*To display the status:*

1. Press **MENU**.
2. Turn the **TUNE knob** to scroll to and highlight **SIRIUS setup**. Press the **TUNE knob**.
3. Turn the **TUNE knob** to scroll to and highlight **Status**. Press the **TUNE knob**.
4. The Status screen will be displayed. Press **MENU** to exit.

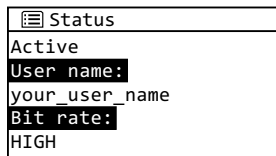

# Configuring Your SIRIUS TTR1C Radio

## System Setup

The System Setup menu option offers the following menu items:

|                    |         |
|--------------------|---------|
| SIRIUS             | page 51 |
| AUX in             | page 51 |
| Alarms             | page 52 |
| Alarm 1:           | page 52 |
| Alarm 2:           | page 52 |
| Brightness         | page 52 |
| Clock Setup        | page 53 |
| Set Time/Date      | page 53 |
| Auto Update        | page 54 |
| Time Zone          | page 54 |
| Daylight savings   | page 55 |
| Network            | page 56 |
| Network wizard     | page 56 |
| View Settings      | page 57 |
| Manual Settings    | page 58 |
| Network profile    | page 58 |
| Factory reset      | page 60 |
| Software update    | page 61 |
| Auto-check setting | page 61 |
| Check now          | page 62 |
| Info               | page 64 |

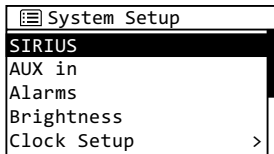

Refer to the sections following for each menu option.

## SIRIUS and AUX in

These two menu options select what the radio will play— **SIRIUS** selects the SIRIUS Internet Radio service to be played, and **AUX in** selects the auxiliary input to be played. You can connect a CD or MP3 player to the **AUX In** connector, and listen to it.

### *To select auxiliary in to be played:*

1. Press **MENU**.
2. Turn the **TUNE knob** to scroll to and highlight **System Setup**. Press the **TUNE knob**.
3. Turn the **TUNE knob** to scroll to and highlight **AUX in**. Press the **TUNE knob**.
4. The **Auxiliary input** screen will be displayed, and the radio will play the input from the **AUX In** connector.

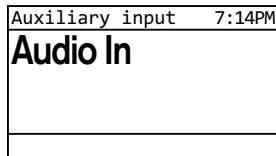

### *To switch from AUX in to SIRIUS:*

1. Press **MENU**.
2. Turn the **TUNE knob** to scroll to and highlight **System Setup**. Press the **TUNE knob**.
3. **SIRIUS** will be highlighted. Press the **TUNE knob**.
4. The radio will switch back to SIRIUS and connect to the SIRIUS Internet Radio service.

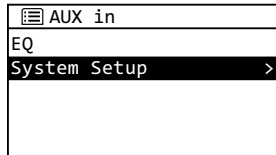

# Configuring Your SIRIUS TTR1C Radio

## Alarms

Before setting any alarms, refer to “Clock Setup” on page 53 and ensure that the clock is set correctly, i.e., the Time Zone and Daylight Savings Time are set correctly for your location. Then refer to “Alarm Clock” on page 32 for information about the alarm clocks. Refer to “Snooze” on page 34 for more information about the snooze function.

## Brightness

**Brightness** has four settings to set the brightness of the display screen, Automatic, High, Medium, and Low. The **Automatic** setting adjusts the brightness of the display screen according to the background light in the room, automatically dimming the display screen the darker the room.

*To change the display screen brightness:*

1. Press **MENU**.
2. Turn the **TUNE knob** to scroll to and highlight **System Setup**. Press the **TUNE knob**.
3. Turn the **TUNE knob** to scroll to and highlight **Brightness**. Press the **TUNE knob**.
4. Turn the **TUNE knob** to display your desired setting, Automatic, High, Medium, or Low. Press the **TUNE knob** to select your setting.
5. Press **MENU** to exit.

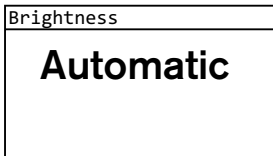

## Clock Setup

Clock Setup allows you to change the clock settings:

- **Set Time/Date** - Change the time and/or date.
- **Auto Update** - Synchronize the clock via the Internet Yes or No. **Yes** is the default and preferred setting. The radio will automatically update the time, keeping it accurate.
- **Time Zone** - Select the time zone you are in.
- **Daylight savings** - Turn daylight savings time On or Off.

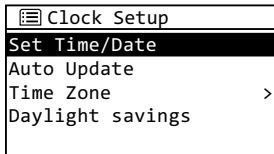

*To set the time and date:*

1. Press **MENU**.
2. Turn the **TUNE knob** to scroll to and highlight **System Setup**. Press the **TUNE knob**.
3. Turn the **TUNE knob** to scroll to and highlight **Clock Setup**. Press the **TUNE knob**.
4. **Set Time/Date** will be highlighted. Press the **TUNE knob**.
5. Turn the **TUNE knob** to select the desired hour, and press the **TUNE knob** to advance to the next field. Continue doing this until you have finished.

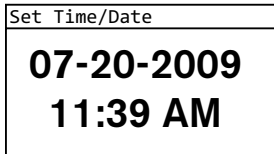

# Configuring Your SIRIUS TTR1C Radio

## *To set Auto Update:*

1. Press **MENU**.
2. Turn the **TUNE knob** to scroll to and highlight **System Setup**. Press the **TUNE knob**.
3. Turn the **TUNE knob** to scroll to and highlight **Clock Setup**. Press the **TUNE knob**.
4. Turn the **TUNE knob** to scroll to and highlight **Auto Update**. Press the **TUNE knob**.
5. Turn the **TUNE knob** to select either **YES** or **NO**, and press the **TUNE knob**.
6. Press **MENU** to exit.

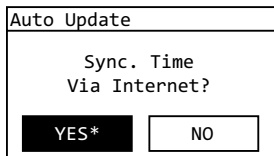

## *To set your time zone:*

1. Press **MENU**.
2. Turn the **TUNE knob** to scroll to and highlight **System Setup**. Press the **TUNE knob**.
3. Turn the **TUNE knob** to scroll to and highlight **Clock Setup**. Press the **TUNE knob**.
4. Turn the **TUNE knob** to scroll to and highlight **Time Zone**. Press the **TUNE knob**.

5. Turn the **TUNE knob** to scroll to and highlight the time zone you are in. Press the **TUNE knob**.
6. Press **MENU** to exit.

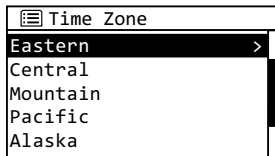

*To set daylight savings time:*

1. Press **MENU**.
2. Turn the **TUNE knob** to scroll to and highlight **System Setup**. Press the **TUNE knob**.
3. Turn the **TUNE knob** to scroll to and highlight **Clock Setup**. Press the **TUNE knob**.
4. Turn the **TUNE knob** to scroll to and highlight **Daylight savings**. Press the **TUNE knob**.
5. Turn the **TUNE knob** to select either **ON** or **OFF**, and press the **TUNE knob**.
6. Press **MENU** to exit.

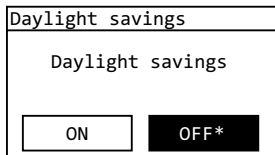

# Configuring Your SIRIUS TTR1C Radio

## Network

Network allows you to view and change the network settings:

- **Network wizard** - Helps you to easily connect to a network
- **View settings** - Displays information about your network connection
- **Manual Settings** - Allows you to manually setup your connection to a network
- **Network profile** - Displays the wireless network connections saved in the radio

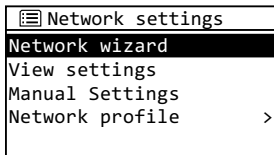

Each **Network** menu option is discussed in the sections which follow.

### **Network Wizard:**



**IMPORTANT!** To connect to a wireless network which restricts access by MAC address, the MAC address of the SIRIUS TTR1C Internet Radio must be added to the allowed list of MAC addresses in the access point before connecting. You can find the MAC address of your radio by pressing **MENU**, then turning and pressing the **TUNE knob** to highlight and select: **System Setup** → **Network** → **View settings**. The MAC address of the SIRIUS TTR1C Internet Radio will be displayed.

Refer to one the following sections for detailed instructions on using the **Network Wizard** to connect to a network:



- For connecting to a wireless network, refer to “To connect to a wireless network using the Network Wizard” on page 18.
- For connecting to a wired network, refer to “To connect to a wired network using the Network Wizard:” on page 21.

### *View settings:*

View Settings displays information about your network connection, including the type of connection, the status, the radio's MAC address, and other network connection details such as IP addresses.

### *To view the network settings:*

1. Press **MENU**.
2. Turn the **TUNE knob** to scroll to and highlight **System Setup**. Press the **TUNE knob**.
3. Turn the **TUNE knob** to scroll to and highlight **Network**. Press the **TUNE knob**.
4. Turn the **TUNE knob** to scroll to and highlight **View settings**. Press the **TUNE knob**.
5. Turn the **TUNE knob** to scroll through the network settings.
6. Press **MENU** to exit.

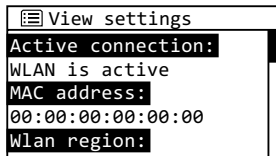

# Configuring Your SIRIUS TTR1C Radio

## **Manual Settings:**

Refer to one the following sections for detailed instructions on using the **Manual Settings** to connect to a network:

- For connecting to a wireless network, refer to “Connect to a Wireless Network Using Manual Settings” on page 66.
- For connecting to a wired network, refer to “Connect to a Wired Network Using Manual Settings” on page 71.

## **Network profile:**

**Network profile** displays the wireless network connections which are stored in the radio when you connect to a wireless network. The currently active profile is denoted with a “\*”. You can delete the profiles if desired.

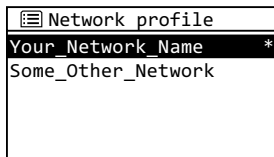

## **To view and delete the network profiles:**

Note that you cannot delete the active wireless network profile.

- 1.** Press **MENU**.
- 2.** Turn the **TUNE knob** to scroll to and highlight **System Setup**. Press the **TUNE knob**.

3. Turn the **TUNE knob** to scroll to and highlight **Network**. Press the **TUNE knob**.
4. Turn the **TUNE knob** to scroll to and highlight **Network profile**. Press the **TUNE knob**.
5. The saved wireless network names will be displayed. If you wish to delete a profile, turn the **TUNE knob** to scroll to and highlight a profile name. Press the **TUNE knob**.
6. Confirm that you really want to delete the profile. Turn the **TUNE knob** to highlight YES or NO and press the **TUNE knob**.
7. Press **MENU** to exit.

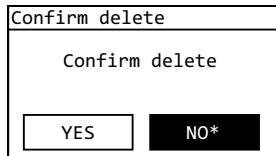

# Configuring Your SIRIUS TTR1C Radio

## Factory reset

**Factory reset** restores the SIRIUS TTR1C Internet Radio to the factory settings. It will erase all the stored network settings, account user name and password, favourite channels, alarm clock settings, lock code, and set all other options back to the factory settings.

*To restore the radio to the factory settings:*

1. Press **MENU**.
2. Turn the **TUNE knob** to scroll to and highlight **System Setup**. Press the **TUNE knob**.
3. Turn the **TUNE knob** to scroll to and highlight **Factory reset**. Press the **TUNE knob**.
4. Confirm that you really want to proceed with the factory reset. Turn the **TUNE knob** to highlight YES or NO and press the **TUNE knob**.
5. The screen will display Restarting and the radio turn off.

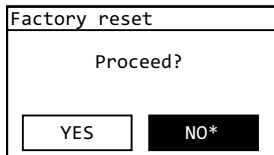

## Software update

**Software update** allows you to set the radio to automatically check for any available software updates, and also to manually force the radio to check if an update is available. SIRIUS occasionally updates the software for their radios. Check [www.sirius.ca](http://www.sirius.ca) for any updated documentation associated with a software update.

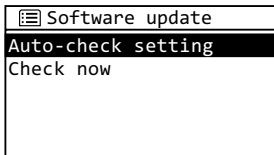

By default, the SIRIUS TTR1C Internet Radio is set to automatically check for updates. If it finds a software update, you'll be prompted that a new software is available. You can change this setting so the radio will not automatically check for updates.

### *To change automatic software updates:*

1. Press **MENU**.
2. Turn the **TUNE knob** to scroll to and highlight **System Setup**. Press the **TUNE knob**.
3. Turn the **TUNE knob** to scroll to and highlight **Software Update**. Press the **TUNE knob**.
4. Turn the **TUNE knob** to scroll to and highlight **Auto-check setting**. Press the **TUNE knob**.
5. Select whether you periodically

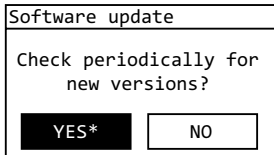

# Configuring Your SIRIUS TTR1C Radio

want the radio to check for software updates. Turn the **TUNE knob** to highlight YES or NO and press the **TUNE knob**.

6. Press **MENU** to exit.

*To force the radio to check for a software update:*

1. Press **MENU**.
2. Turn the **TUNE knob** to scroll to and highlight **System Setup**. Press the **TUNE knob**.
3. Turn the **TUNE knob** to scroll to and highlight **Software Update**. Press the **TUNE knob**.
4. Turn the **TUNE knob** to scroll to and highlight **Check now**. Press the **TUNE knob**.
5. The radio will check for a software update. If an update is available, the radio will download and install the update. If no update is available, **Software up to date** will be displayed. If a software update is available, **Software update** is displayed.
6. Press **MENU** to exit.

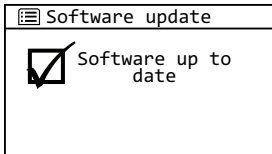
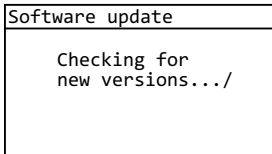

### Updating the software:

If you manually force the radio to check for a software update, or the radio automatically finds a software update, and you want to update the software, follow these steps.

1. The **Software update** screen is displayed. Turn the **TUNE knob** to highlight **YES** and press the **TUNE knob**.
2. The radio will download the software update. Allow the download to finish.
3. When the download is complete, you will be prompted to proceed with the installation of the software. The default answer is **YES**. Press the **TUNE knob** to proceed.
4. You will be warned not to power off the radio, and the radio will be updated with the new software.
5. When the update is complete, you'll be prompted to **Press OK/Tune to start**. Press the **TUNE knob**.

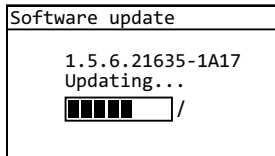
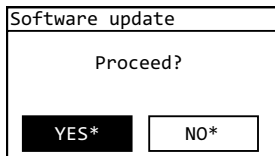
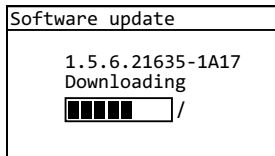
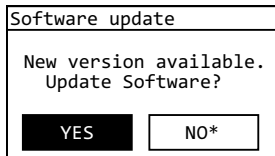

# Configuring Your SIRIUS TTR1C Radio

- The radio will start with the new software.

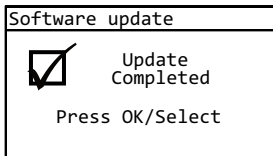

## Info

**Info** displays the software version number, and the Radio ID number.

*To display the information:*

- Press **MENU**.
- Turn the **TUNE knob** to scroll to and highlight **System Setup**. Press the **TUNE knob**.
- Turn the **TUNE knob** to scroll to and highlight **Info**. Press the **TUNE knob**.
- The software version number, and the Radio ID number will be displayed.
- Press **MENU** to exit.

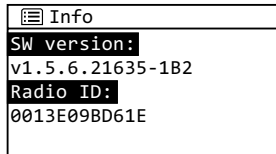





# Appendix: Manual Network Configuration

Connecting to a network using the **Manual settings** requires some knowledge of your network. You'll need to manually configure your network connection using the **Manual Settings** or **[Manual config]** option if your wireless network name (SSID) is hidden, or if your network is DHCP disabled.

Decide whether you will be using a wireless network connection (page 66), or a wired Ethernet connection (page 71). Then follow the instructions in the appropriate following section.

## Connect to a Wireless Network Using Manual Settings

In order to connect to a wireless network, you will need to have the following information to enter during the procedure:

|   |  |
|---|--|
| Is DHCP enabled or disabled?                      |  |
| If disabled, the IP address to use for the radio? |  |
| If disabled, the Subnet Mask?                     |  |
| If disabled, the Gateway IP address?              |  |
| If disabled, the Primary DNS IP address?          |  |
| If disabled, the Secondary IP address?            |  |
| The name of your wireless network (SSID)?         |  |
| Is the wireless network password protected?       |  |
| If so, the type of authentication?                |  |
| If Pre-Shared Key, whether WEP is enabled?        |  |
| If WPA or WPA2, whether it's TKIP or AES?         |  |
| The wireless network key (password)?              |  |

- a. If you have just turned your SIRIUS TTRIC Internet Radio on for the first time, the SSID screen will already be displayed. Skip ahead to step d.
- b. Press **MENU** and turn the **TUNE knob** to highlight **System Setup**. Press the **TUNE Knob**.
- c. Turn the **TUNE knob** to highlight **Network**. Press the **TUNE Knob**.
- d. Turn the **TUNE Knob** to highlight **Manual Settings** or **[Manual config]**. Press the **TUNE Knob**.
- e. Turn the **TUNE Knob** to highlight **Wireless**. Press the **TUNE Knob**.
- f. Will you be using DHCP? Turn the **TUNE Knob** to highlight **DHCP enable** or **DHCP disable** and press the **TUNE Knob**.
- g. If you have selected **DHCP disable**, enter the following information. Otherwise, continue with step h.

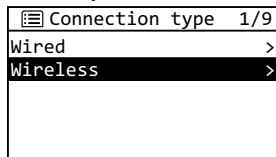

For each entry, Turn the **TUNE knob** to select the numbers, and press the **TUNE knob** to confirm and move to the next number. Press **BACK** if you entered an incorrect number.



**TIP!** You can use the Remote Control to increment the numbers (∧ ∨), and move forward or backward through the number fields (+ and -).

- i. Enter the IP address to use for the radio.
- ii. Enter the Subnet Mask for the network.

# Appendix: Manual Network Configuration

- iii. Enter the Gateway IP address for the network.
- iv. Enter the Primary DNS IP address for the network.
- v. Enter the Secondary DNS IP address for the network, or leave blank if there is none.

|                     |     |
|---------------------|-----|
| ☰ IP settings       | 3/9 |
| IP address          |     |
| 0 . 0 . 0 . 0       |     |
| Subnet mask         |     |
| 255 . 255 . 255 . 0 |     |

- h.** Enter your wireless network name (SSID). Note that the SSID is case sensitive. Turn the **TUNE knob** to scroll through the list of characters and highlight each character. Press the **TUNE knob** to select the highlighted character and move to the next character. If you make a mistake, turn the **TUNE knob** to highlight **BKSP** and press the **TUNE knob** to erase the character. When done, turn the **TUNE knob** to highlight **OK** and press the **TUNE knob**.

|                        |     |
|------------------------|-----|
| ☰ Key:                 | 9/9 |
| 123456789., ab BKSP    |     |
| cdefghijklmnopq OK     |     |
| rstuvwxyzABCDEF CANCEL |     |
| GHIJKLMNOPQRSTU        |     |

- i.** Select the authentication type, Open (no key (password)), Pre-Shared Key, WPA, or WPA2. Turn the **TUNE Knob** to highlight your selection and press the **TUNE knob**. If you have selected Open, skip ahead to step k.

|                  |     |
|------------------|-----|
| ☰ Authentication | 7/9 |
| Open             |     |
| Pre-Shared Key > |     |
| WPA              |     |
| WPA2             |     |

- j.** Depending upon your selection, complete these additional steps:

- **Pre-Shared Key:**

- i. Select whether the Pre-Shared Key has WEP encryption disabled or

disabled. Turn the **TUNE Knob** to highlight your selection and press the **TUNE knob**.

- ii. Enter your key (password). Turn the **TUNE knob** to scroll through the list of characters and highlight each character. Press the **TUNE knob** to select the highlighted character and move to the next character. If you make a mistake, turn the **TUNE knob** to highlight **BKSP** and press the **TUNE knob** erase the character.

• **WPA or WPA2:**

- i. Select whether WPA or WPA2 has TKIP or AES encryption. Turn the **TUNE Knob** to highlight your selection and press the **TUNE knob**.
- ii. Enter your key (password). Remember that the key is case sensitive. Turn the **TUNE knob** to scroll through the list of characters and highlight each character. Press the **TUNE knob** to select the highlighted character and move to the next character. If you make a mistake, turn the **TUNE knob** to highlight **BKSP** and press the **TUNE knob** to erase the character. When done, turn the **TUNE knob** to highlight **OK** and press the **TUNE knob**.

- k. If you have entered the correct information, and the radio is able

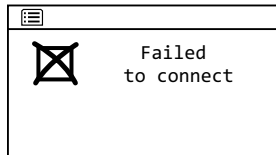
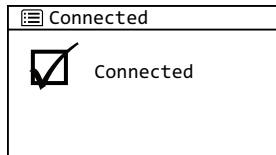

# Appendix: Manual Network Configuration

to connect to your wireless network, the **Connected** screen will be displayed. If not, the **Failed to connect screen** is displayed. This means that one or more of the settings you entered is incorrect.

- I. If you are installing your SIRIUS TTRIC Internet Radio for the first time, continue with “Step 2: Enter Your SIRIUS Account Information” on page 23.

If you have previously entered your SIRIUS user name and key into the radio, and had tuned to a channel, the screen will show **Connecting**. When successfully connected, the **Buffering...** screen will be displayed as the channel information is streamed to the radio. When complete, you are returned to the main display screen and you should hear the audio playing. Otherwise, the **Category Tune** screen is displayed.

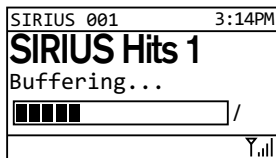
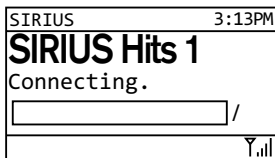

## Connect to a Wired Network Using Manual Settings

In order to connect to a wired network, you will need to have the following information to enter during the procedure:

|   |  |
|---|--|
| Is DHCP enabled or disabled?                      |  |
| If disabled, the IP address to use for the radio? |  |
| If disabled, the Subnet Mask IP address?          |  |
| If disabled, the Gateway IP address?              |  |
| If disabled, the Primary DNS IP address?          |  |
| If disabled, the Secondary DNS IP address?        |  |

- a. At the rear of the radio, remove the compartment cover and connect an Ethernet cable to the Ethernet connector on the inside left of the compartment. Refer to "Wired Ethernet Connector" on page 11 for the location of the Ethernet connector. Replace the compartment cover.
- b. Connect the other end of the Ethernet cable to your home's wired network.
- c. If you have just turned your SIRIUS TTR1C Internet Radio on for the first time, the SSID screen will already be displayed. Skip ahead to step f.
- d. Press **MENU** and turn the **TUNE knob** to highlight **System Setup**. Press the **TUNE Knob**.
- e. Turn the **TUNE knob** to highlight **Network**. Press the **TUNE Knob**.
- f. Turn the **TUNE Knob** to highlight **Manual Settings [Manual config]**. Press the **TUNE Knob**.

# Appendix: Manual Network Configuration

- g.** Turn the **TUNE Knob** to highlight **Wired**. Press the **TUNE Knob**.

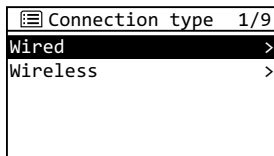

- h.** Will you be using DHCP? Turn the **TUNE Knob** to highlight **DHCP enable** or **DHCP disable** and press the **TUNE Knob**.

- i.** If you have selected **DHCP disable**, enter the following information. Otherwise, continue with step j.

For each entry, Turn the **TUNE knob** to select the numbers, and press the **TUNE knob** to confirm and move to the next number. Press **BACK** if you entered an incorrect number.



**TIP!** You can use the Remote Control to increment the numbers ( $\wedge$   $\vee$ ), and move forward or backward through the number fields ( $+$  and  $-$ ).

- i. Enter the IP address to use for the radio.
- ii. Enter the Subnet Mask IP address for the network.
- iii. Enter the Gateway IP address for the network.
- iv. Enter the Primary DNS IP address for the network.
- v. Enter the Secondary DNS IP address for the network, or leave blank if there is none.

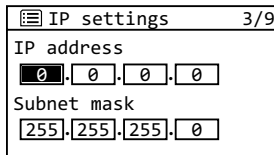

- j.** If you have entered the correct information, and the radio is able to connect to your network, the **Connected** screen will be displayed. If not, the **Failed to connect screen** is displayed. This means that one or



more of the settings you entered is incorrect. If **Waiting for Ethernet** is displayed, check the Ethernet cable connections.

- k. If you are installing your SIRIUS TTR1C Internet Radio for the first time, continue with “Step 2: Enter Your SIRIUS Account Information” on page 23.

If you have previously entered your SIRIUS user name and key into the radio, and had tuned to a channel, the screen will show **Connecting**. When successfully connected, the **Buffering...** screen will be displayed as the channel information is streamed to the radio. When complete, you are returned to the main display screen and you should hear the audio playing. Otherwise, the **Category Tune** screen is displayed.

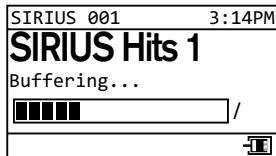
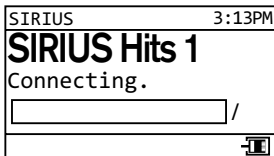
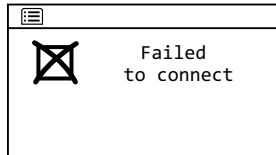
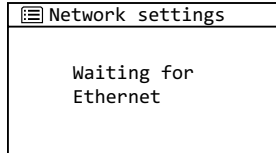
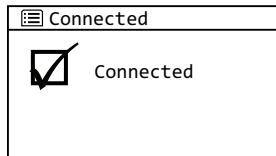



# Troubleshooting

# Troubleshooting

Your SIRIUS TTR1C Internet Radio has been designed and built to be trouble-free but if you experience a problem, here's some troubleshooting hints.

You can also call SIRIUS Customer Care at 1-888-539-7474.

| If you see this on the screen: | Try this:  |
|--------------------------------|--|
| Connecting                     | <ul style="list-style-type: none"><li>• The radio is attempting to connect to the SIRIUS Internet Radio service. If this message is displayed more than one minute, make sure your network is connected to the Internet.<br/>To verify that you have an Internet connection, refer to "To force the radio to check for a software update:" on page 62 and follow the procedure. If you get the message <b>Software up to date</b>, or <b>New version available</b>, then the radio is connected to the Internet. If you get the message, <b>Login failed</b>, then you don't have an Internet connection. Check with your network administrator for Internet connectivity on your network.</li><li>• Turn your radio Off and On again.</li></ul> |
| Buffering                      | <ul style="list-style-type: none"><li>• The radio is loading the channel information. If this message is displayed for more than one minute, make sure your connection to the Internet has not been interrupted. See <b>Connecting</b> (previous troubleshooting item) and verify your Internet connection.</li><li>• Turn your radio Off and On again.</li></ul>  |
| Updating                       | <ul style="list-style-type: none"><li>• Your radio is installing a software update. Do not turn the radio off. Allow the software update complete.</li></ul>   |

| If you see this on the screen: | Try this:   |
|--------------------------------|---|
| Waiting for Ethernet           | <ul style="list-style-type: none"> <li>• The radio is expecting a wired Ethernet connection. Plug an Ethernet wire into your home network, then plug the other end into the Ethernet connection inside the compartment at the rear of the radio. (Refer to page 11 for the location of the connector.)</li> <li>• Change to a wireless network connection if a wired Ethernet connection is not available.</li> </ul>   |
| Login failed                   | <ul style="list-style-type: none"> <li>• Your SIRIUS user name and/or password is incorrect, you don't have a subscription to the SIRIUS Satellite Radio service, or your subscription is no longer valid. To verify that you are subscribed to service, go to <a href="http://www.sirius.ca">www.sirius.ca</a>, click on the <b>LISTEN ONLINE</b> link, and then click the <b>LAUNCH PLAYER</b> link. Enter your username and password. Select a channel to listen to. If you can listen, then you are subscribed. Close the browser window to exit the player before continuing.</li> </ul> <p>If you don't have a SIRIUS Satellite Radio subscription, go to <a href="http://www.sirius.ca">www.sirius.ca</a> or call 888-539-7474 to subscribe and get your user name and password.</p> |

# Troubleshooting

| If you see this on the screen:  | Try this:   |
|---|---|
| Failed to connect   | <ul style="list-style-type: none"><li>• The network information you entered is incorrect. Verify and re-enter the information. (Refer to page 17 for a wireless network, or page 21 for a wired network.)</li><li>• You have entered an incorrect password for a secure wireless network. Verify and re-enter the information. (Refer to page 23.)</li><li>• If you have manually configured a network connection, you have entered one or more incorrect settings. Verify and re-enter the information. (Refer to page 66 for a wireless network, or page 71 for a wired network.)</li></ul> |
| Stream Closed   | <ul style="list-style-type: none"><li>• Your account username and password has been used at another location to connect to the Premium SIRIUS Internet Radio service, and your radio has been disconnected from the service. Turn your radio Off and On again.</li><li>• The radio may have timed out due to lack of activity. Turn your radio Off and On again. To prevent a time-out, periodically adjust the volume, change the channel, or enter a menu, etc.</li></ul>   |
| If this happens:  | Try this:   |
| You do not receive the same SIRIUS channels you receive on your Satellite Radio | <ul style="list-style-type: none"><li>• The SIRIUS Internet Radio service does not have all of the same channels as the SIRIUS satellite service.<br/>Check <a href="http://www.sirius.ca">www.sirius.ca</a> and click the <b>View Channel Lineup</b> link for the latest channel lineup.</li></ul>   |

| <b>If this happens:</b>  | <b>Try this:</b>  |
|--|---|
| The Network Wizard fails before the radio connects to your network | <ul style="list-style-type: none"><li>• Your network has DHCP disabled. You'll have to manually configure your network connection. (Refer to page 66 for a wireless network, or page 71 for a wired network.)</li></ul>   |
| The Network Wizard does not find your wireless network             | <ul style="list-style-type: none"><li>• Your wireless network has a hidden name (SSID). If so, you will have to manually configure your wireless network connection (page 66), or use a wired network connection (page 21 or page 71).</li><li>• The wireless signal from your access point is too low. Try moving the radio closer to your access point and see if the Network Wizard finds your wireless network.</li></ul> |





# Product Specifications

# Product Specifications

## Dimensions

|                             |  |
|-----------------------------|--|
| SIRIUS TTR1C Internet Radio | 283 mm (W) x 185 mm (H) x 95 mm (D)<br>11 in (W) X 7.25 in (H) X 3.75 in (D) |
| Remote                      | 52 mm (W) x 85 mm (H) x 5 mm (D)<br>2 in (W) x 3.3 in (H) x .25 in (D)       |

## Weight

|                             |                   |
|-----------------------------|-------------------|
| SIRIUS TTR1C Internet Radio | 2.85 kg (6.3 lbs) |
|-----------------------------|-------------------|

## Audio Outputs

|           |                                  |
|-----------|----------------------------------|
| Headphone | 3.5 mm diameter mini stereo jack |
| Line Out  | 3.5 mm diameter mini stereo jack |

## Audio Input

|        |                                  |
|--------|----------------------------------|
| Aux In | 3.5 mm diameter mini stereo jack |
|--------|----------------------------------|

# Patent and Environmental Information

## Patent Information

It is prohibited to, and you agree that you will not, copy, decompile, disassemble, reverse engineer, hack, manipulate, or otherwise access and/or make available any technology incorporated in this product. Furthermore, the AMBE® voice compression software included in this product is protected by intellectual property rights including patent rights, copyrights, and trade secrets of Digital Voice Systems, Inc. The software is licensed solely for use within this product. The music, talk, news, entertainment, data, and other content on the Services are protected by copyright and other intellectual property laws and all ownership rights remain with the respective content and data service providers. You are prohibited from any export of the content and/or data (or derivative thereof ) except in compliance with applicable export laws, rules and regulations. The user of this or any other software contained in a SIRIUS radio is explicitly prohibited from attempting to copy, decompile, reverse engineer, hack, manipulate or disassemble the object code, or in any other way convert the object code into human-readable form.

## Environmental Information

Follow local guidelines for waste disposal when discarding packaging and electronic appliances.

Your radio is packaged with cardboard, polyethylene, etc., and does not contain any unnecessary materials.

# FCC Statement

The user is cautioned that changes or modifications not expressly approved by Sirius Canada Inc. can void the user's authority to operate this device.

This device complies with Part 15 of the FCC Rules:

1. This device may not cause harmful interference.
2. This device must accept any interference received, including interference that may cause undesired operation.

NOTE: This equipment has been tested and found to comply with the limits for a Class B digital device, pursuant to Part 15 of the FCC Rules. These limits are designed to provide reasonable protection against harmful interference in a residential installation. This equipment generates, uses and can radiate radio frequency energy and, if not installed and used in accordance with the instructions, may cause harmful interference to radio communications. However, there is no guarantee that interference will not occur in a particular installation. If this equipment does cause harmful interference to radio or television reception, which can be determined by turning the equipment off and on, the user is encouraged to try to correct the interference by one or more of the following measures:

- To comply with FCC RF exposure compliance requirements, a separation distance of at least 20 cm must be maintained between the antenna of this device and all persons.
- This device must not be co-located or operating in conjunction with any other antenna or transmitter.

## Canadian Compliance

This Class B digital apparatus complies with Canadian ICES-003.

Operation is subject to the following two conditions: (1) this device may not cause interference, and (2) this device must accept any interference, including interference that may cause undesired operation of the device.

To reduce potential radio interference to other users, the antenna type and its gain should be so chosen that the equivalent isotropically radiated power (EIRP) is not more than that required for successful communication

This device has been designed to operate with an antenna having a maximum gain of 2 dBi. Antenna having a higher gain is strictly prohibited per regulations of Industry Canada. The required antenna impedance is 50 ohms.

To reduce potential radio interference to other users, the antenna type and its gain should be so chosen that the equivalent isotropically radiated power (e.i.r.p.) is not more than that permitted for successful communication.

**IC Radiation Exposure Statement:**

This equipment complies with IC RSS-102 radiation exposure limits set forth for an uncontrolled environment. This equipment should be installed and operated with minimum distance 20cm between the radiator & your body.

The Country Code Selection feature is disabled for products marketed in the US/Canada.

This device and its antenna(s) must not be co-located or operating in conjunction with any other antenna or transmitter.

This Class [B] digital apparatus complies with Canadian ICES-003.

# Copyrights and Trademarks

©2010 SIRIUS Canada Inc. "SIRIUS", "SIRIUS Satellite Radio" and the SIRIUS dog logo are trademarks of SIRIUS XM Radio Inc. and are used under licence. All other marks and logos are the property of their respective owners. All rights reserved. Hardware, subscription and activation fee required. Other fees and taxes will apply. Month-to-month subscriptions must be activated via telephone. Hardware and subscription sold separately. Subscription governed by SIRIUS Terms & Conditions available at [sirius.ca](http://sirius.ca).



**sirius.ca**

**Sirius Canada Inc.  
135 Liberty St. - 4th floor  
Toronto, Ontario, M6K 1A7**

1-888-539-SIRIUS (7474)

© 2010 Sirius Canada Inc.

SIRIUS TTR1C 071310a