



User Guide

Universal Home Kit

Table of Contents

Compatibility	3
Introduction	4
Safety and Care Information	5
What's in the Box?	6
Home Dock Color-Coded Connections	7
Home Installation	8
Step 1: Insert the Radio Dock Adapter Into the Dock	8
Step 2: Connect the Home Dock and Dock the Radio	11
Step 3: Place and Aim the Indoor/Outdoor Home Antenna	13
Step 4: Connect the Home Dock to a Stereo System or Powered Speakers	17
Troubleshooting	20
Product Specifications	23
Patent Information	24
Environmental Information	24
Patent and Environmental Information	24
IC Statement	25
Copyrights and Trademarks	26
Indoor/Outdoor Home Antenna Template	27

Compatibility

This Universal Home Kit is compatible with the following Dock & Play Radios:

SiriusXM:

- Onyx Plus
- Edge

XM:

- Onyx
- Onyx EZ
- XpressRCi
- XpressRC
- XpressR

Sirius:

- Sportster 5
- Starmate 8, 5, 4, 3
- Stratus 7, 6, 5
- Stratus

Introduction

Thank you for purchasing the SiriusXM Universal Home Kit!

The Home Kit lets you play your compatible XM or SiriusXM Dock & Play Radio through your home stereo system or powered speakers.

- There is no need for a second subscription. Just connect this Home Kit to a stereo system or set of powered speakers - and then simply move your Radio from any location to your home or office.
- This Home Kit works with a set of powered speakers or any stereo system with audio input jacks.

And for the latest information about this and other SiriusXM products and accessories, visit siriusxm.ca or your favorite retailer.

Please read the entire User Guide before installing your Universal Home Kit!

Introduction

Safety and Care Information



IMPORTANT! Self installation instructions and tips are provided for your convenience. It is your responsibility to determine if you have the knowledge, skills, and physical ability required to properly perform an installation. SiriusXM shall have no liability for damage or injury resulting from the installation or use of any SiriusXM or third party products. SiriusXM product warranties do not cover the installation, removal or reinstallation of any product.

- Do not expose to extreme temperatures (above 140°F or below -4°F, or above 60°C or below -20°C).
- Do not expose to moisture. Do not use device near or in water. Do not touch the device with wet hands.
- Do not let any foreign matter spill into device.
- Do not store in dusty areas.
- Do not expose to chemicals such as benzene and thinners. Do not use liquid or aerosol cleaners. Clean with a soft damp cloth only.
- Do not expose to direct sunlight for a prolonged period of time, and do not expose to fire, flame, or other heat sources.
- Do not try to disassemble and/or repair the device yourself.
- Do not drop your device or subject it to severe impact.
- Do not place heavy objects on device.
- Do not subject device to excessive pressure.

WARNING!

- Opening the case may result in electric shock.
- Make sure that you insert the Home Power Adapter's plug all the way into the outlet.
- This product contains chemicals known to the State of California to cause cancer and birth defects or other reproductive harm.

Introduction

What's in the Box?

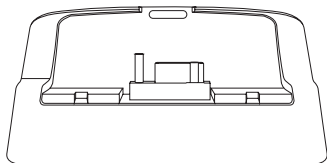

Home Dock

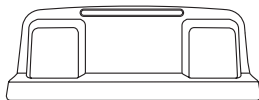

XM & SiriusXM Radio Dock Adapter

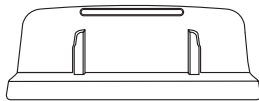

Sirius Radio Dock Adapter



Indoor/Outdoor Home Antenna

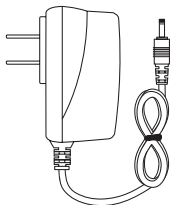

Home Power Adapter



Stereo Audio Cable

Introduction

Home Dock Color-Coded Connections

The color-coded Home Dock makes it simple to connect the cables to the appropriate connectors at the rear of the dock.

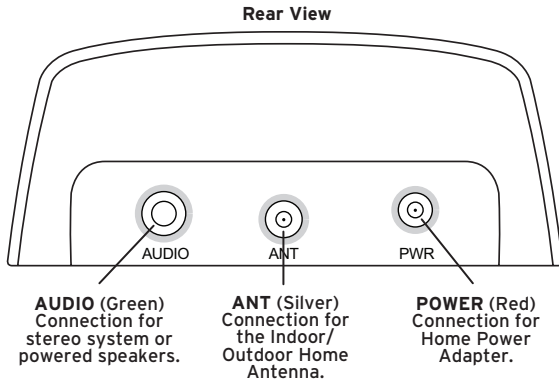

Home Installation

There are several steps to setting up your Home Kit. Follow these steps for an easy installation.

Step 1: Insert the Radio Dock Adapter Into the Dock

You'll need to insert the Radio Dock Adapter that is compatible with your Radio into the Home Dock.

1. Locate the Radio Dock Adapter that is compatible with your Radio.

If you have an XM or SiriusXM Radio: If your Radio is branded as **XM*** or **SiriusXM***, select the Radio Dock Adapter marked **XM & SIRIUSXM** on the back of the adapter.



Back View

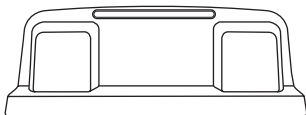

Front View Correct Orientation

If you have a Sirius Radio: If your Radio is branded as **Sirius***, select the Radio Dock Adapter that is marked **SIRIUS** on the back of the adapter.

2. Orient and place the Radio Dock Adapter that you selected into the Home

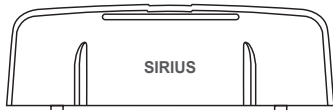

Back View

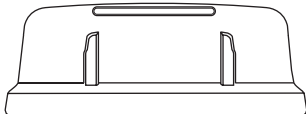

Front View Correct Orientation

*If you are unsure whether your Radio is an XM, SiriusXM, or Sirius Radio, check the label on the back of the Radio. If the label on your Radio says XM Radio ID or Radio ID, and has an 8-digit alphanumeric number, it is an XM or SiriusXM Radio. If the label on your Radio says Sirius ID, SID, or ESN, and has a 12-digit numeric number, it is a Sirius Radio.

Home Installation

Dock. Be sure the adapter is centered, and is seated all the way down into the dock.

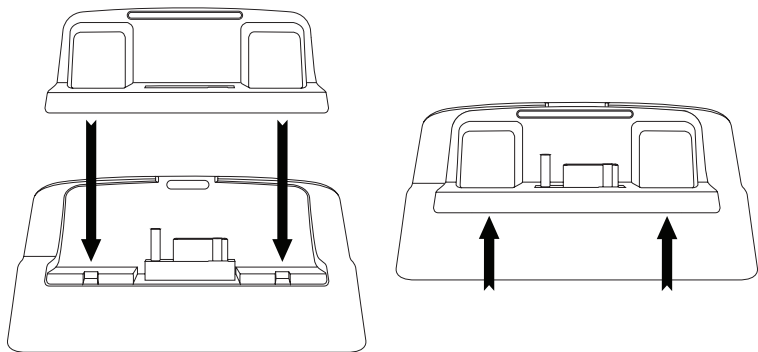

- 3.** Once the adapter is seated correctly in the Home Dock, gently press the top of the adapter against the dock with your finger until it clicks into place. The Radio Dock Adapter is now installed.

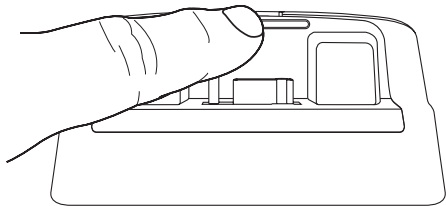

Home Installation

Should it become necessary to remove the Radio Dock Adapter from the Home Dock, use your fingernail to gently press down on the top of the adapter, and then use a long thin object such as a paper clip, a screw driver or something similar to pry the adapter away until it releases from the dock. Then lift the adapter up and out of the dock.

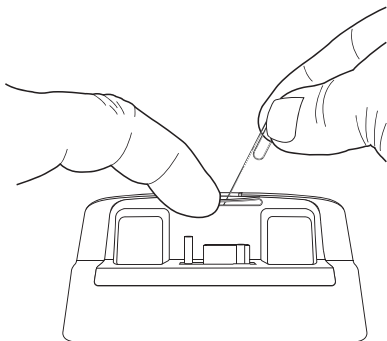

Home Installation

Step 2: Connect the Home Dock and Dock the Radio

When installing the Home Dock in your home, choose a location in close proximity to your stereo system or powered speakers, and also where the cable from the Indoor/Outdoor Home Antenna can reach the Home Dock. The location should be easily accessible and provide good visibility of the display, but should not be located where it will be in direct sunlight, which will affect the visibility of the display screen.

A. Connect the Indoor/Outdoor Home Antenna

Once you have selected a location for the dock, connect the antenna to the **silver ANT** connector at the rear of the Home Dock.

We will work on the location and aiming of the antenna in the next step.

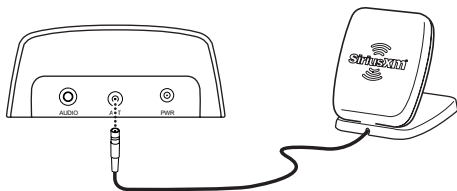

Home Installation

B. Connect the Home Power Adapter

Connect the Home Power Adapter to the **red Power** connector at the rear of the Home Dock, and plug it into a wall outlet.

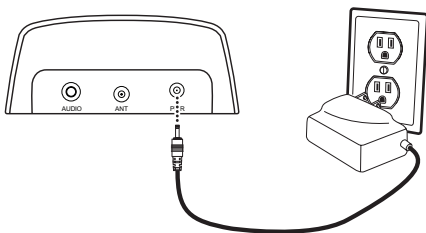

C. Dock Your Radio

Insert your Radio into the Home Dock as shown, and turn the Radio On by pressing the **Power** button.



NOTE: Your Radio may be a different model than the Radio shown here.

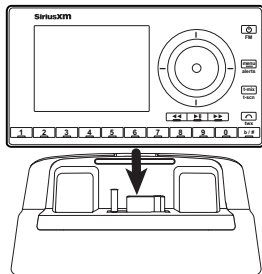

Home Installation

Step 3: Place and Aim the Indoor/Outdoor Home Antenna

To begin, try experimenting with the Indoor/Outdoor Home Antenna to get a feel for the reception in your location. In major metropolitan areas, you might find that you get great reception in several locations without worrying too much about aim and placement. If 2 or 3 vertical bars of signal strength are being displayed, continue with step 4 on page 17.

If there is not at least two bars of signal strength displayed, refer to your Radio's User Guide (go to siriusxm.ca/userguides) for instructions on accessing the **Signal Indicator**, **Signal**, or **Antenna Aiming** screen of your Radio, to see a visual indication of signal strength. Move the antenna around the room or from room to room. Aim it from different windows. If you find a location where you are receiving good Satellite or Terrestrial signal strength (or both), exit the **Signal Indicator**, **Signal**, or **Antenna Aiming** screen. Continue with step 4 on page 17.

If you are unable to find a location where you are receiving good Satellite or Terrestrial signal strength, try some of the suggestions which follow.

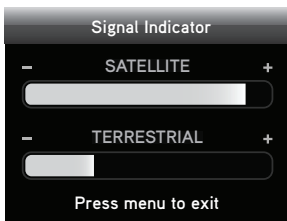

*The screens shown above are representative and may differ from the screens displayed on your Radio.

Home Installation

Other Indoor/Outdoor Home Antenna Installation Suggestions

Try moving the Indoor/Outdoor Home Antenna closer to a window, ideally one that is facing due south.

Not sure which way is south? Think about where the sun rises (in the east) and sets (in the west). Then stand so that east is to your left and you'll be facing south. Is there a window in the direction you're facing? Move the antenna closer to the window.



TIP! Still not sure which way is south or where to place your Indoor/Outdoor Home Antenna? Look up your location on an online mapping website that offers satellite views of street addresses where you can easily see which way is south, and what window may offer an unobstructed view of the sky.

Another easy method is to start at any window, then work from window to window in a simple pattern to find the window that gives the best signal strength. Note that the antenna must also have an unobstructed view, with no trees or buildings blocking its aim. If the antenna is aimed through a window, be aware that blinds, screens, or any other non-glass elements such as thermal insulation can sometimes cause reception issues. If this is the case, you may want to use another window or place the antenna outside of the window.

If you find a window that gives you good signal strength, you can place the antenna on the windowsill. The antenna may need to be placed on something to raise it above the level of the window frame.

If you don't have a window where you receive a consistent signal, or placing the antenna in a window is not a practical solution for you, **BETTER**

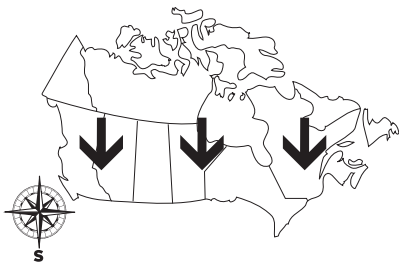

Home Installation

reception can be achieved by placing the antenna outside on a window ledge, porch, table, or patio. The location you choose should provide the antenna with a clear view of the southern sky.

If none of the previous solutions work for you, then the **BEST** reception can be achieved by mounting the antenna outdoors, with a clear view of the southern sky.

Note that you will want to consider any potential hazards when you choose the mounting location, and possibly consider professional installation. Sirius XM Canada Inc. is not liable for any damages.

To mount the antenna, you will need four screws (not included) with a 1/4" head (e.g., an M3 screw), and that are suitable for the material onto which you are affixing the antenna, (e.g., wood, metal, etc.). The screws should be spaced 1-3/8" apart horizontally and 1-1/8" vertically. Refer to the template on "Indoor/Outdoor Home Antenna Template" on page 27.

Once you have found a suitable location for the antenna, route the antenna cable to the Home Dock. Be sure you avoid any obstructions that could crimp, kink, or twist the cable. Use protective grommets

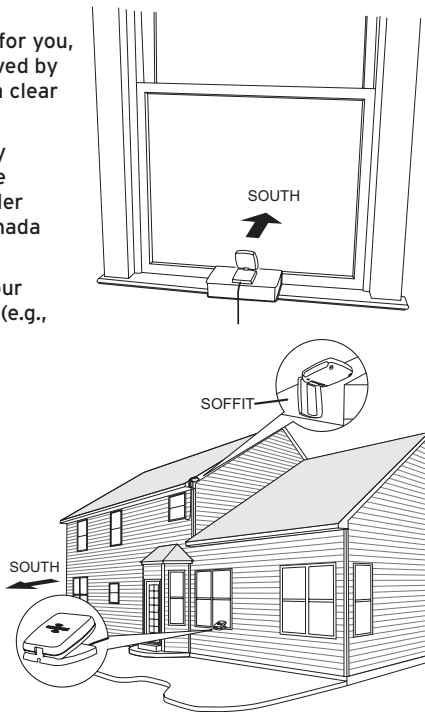

Home Installation

wherever rough openings are encountered. If the antenna is installed outdoors, route the cable from the antenna location to the interior of the home, working the cable through the basement, under a window sill, etc., and make adjustments to take up cable slack as necessary.

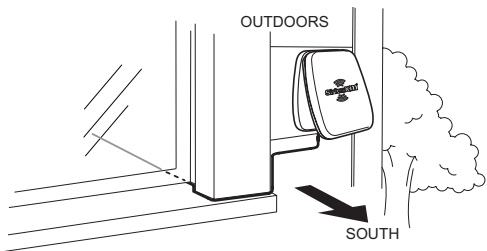

TIP! If your Indoor/Outdoor Home Antenna's cable isn't long enough, visit www.siriusxm.ca, or your favorite retailer, and consider a 50 ft. Home Antenna Extension Cable or a Wireless Home Signal Repeater.

Verify that the antenna is pointed south, and that the antenna's view of the sky is not blocked by a tree, a building, a bridge, or anything else. Try various locations until you find one where you are receiving a good signal.

The Indoor/Outdoor Home Antenna's reception can also be tweaked by opening or closing the antenna clamshell, and turning the antenna.

While observing the signal strength, make small adjustments to the angle of tilt of the clamshell until the highest possible signal strength is achieved. If you have not wall-mounted the antenna, turn the antenna slightly to the right or left and observe if the signal strength increases. For each tweak, allow a few seconds in each position to determine if the signal strength increases.

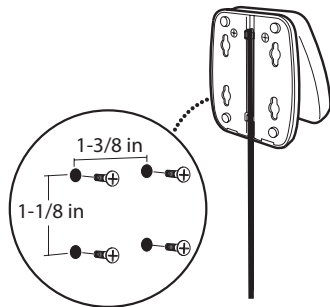

Home Installation

Step 4: Connect the Home Dock to a Stereo System or Powered Speakers

The Home Dock can be connected to your stereo system, or to a set of powered speakers. If you are connecting to a stereo system, see the following section. If you are connecting to a set of powered speakers, see "To Connect the Home Dock to Your Powered Speakers" on page 19.

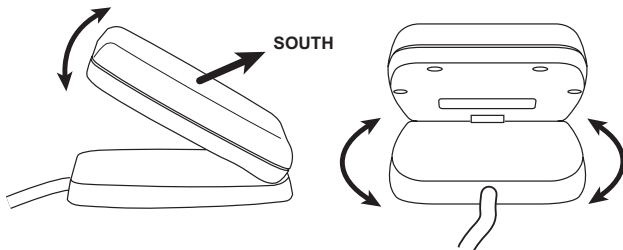

To Connect the Home Dock to Your Stereo System

The Home Dock can be connected to your stereo system through the **Aux In** or **Line In** connection of your stereo system, using the provided Stereo Audio Cable.

1. Take the provided Stereo Audio Cable and connect the single 1/8" (3.5 mm) connector to the **green AUDIO** connector at the rear of the Home Dock.
2. Connect the white left and red right Stereo Audio Cable connectors ("L" and "R" are also on each respective tip) to any available input other than PHONO on your stereo system. (If your stereo's inputs are marked red and black,

Home Installation

simply connect the white plug to the black input.)

3. Turn the stereo system On, and make sure you select the correct input on your stereo system for the **Aux In** or **Line In** connection.
4. If you have connected everything correctly, and you are receiving signal, you should hear the SiriusXM audio.
5. The audio level of your Radio can also be adjusted, if necessary. Refer to your Radio's User Guide (go to siriusxm.ca/userguides) for instructions on how to adjust the audio level. The installation is complete.

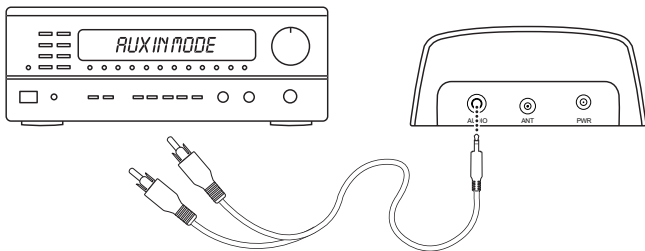

Home Installation

To Connect the Home Dock to Your Powered Speakers

The Home Dock can be connected directly to a set of powered speakers.

1. Connect the 1/8" (3.5 mm) connector from the powered speakers to the **green AUDIO** connector at the rear of the Home Dock.
2. Plug the powered speakers into an AC outlet.
3. Turn On the powered speakers.
4. If you have connected everything correctly, and you are receiving signal, you should hear the SiriusXM audio.
5. The audio level of your Radio can also be adjusted, if necessary. Refer to your Radio's User Guide (go to siriusxm.ca/userguides) for instructions on how to adjust the audio level. The installation is complete.

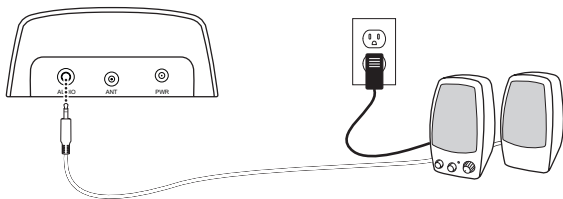

Troubleshooting

Your Home Kit has been designed and built to be trouble-free, but if you experience a problem, try this:

- Check that all connections are firm and secure.
- Make sure you have connected the Home Dock as described in this User Guide. Verify that the AC power outlet is working.

If you see this on the screen:	Try this:
No Signal or No Satellite Signal or Acquiring Signal	<ul style="list-style-type: none">• Move the antenna to a south-facing window. Not sure which way is south? Think about where the sun rises (in the east) and sets (in the west). Then stand so that east is to your left and you'll be facing south. Is there a window in the direction you're facing?• You may need to find a better location for the antenna. Refer to "Step 3: Place and Aim the Indoor/Outdoor Home Antenna" on page 13.
Check Antenna Connection or Check Antenna or Antenna	<ul style="list-style-type: none">• Make sure that the Indoor/Outdoor Home Antenna cable is firmly and securely plugged into the Home Dock. Make sure the cable is not bent or broken.• Turn the Radio off, then on, to reset this message.• If the message persists, most likely the Indoor/Outdoor Home Antenna cable has been damaged. Replace the antenna.
Channel Off Air or Channel Unavailable	<ul style="list-style-type: none">• The channel you've selected is not currently broadcasting. Tune to another channel.
Loading	<ul style="list-style-type: none">• Your Radio is acquiring audio or program information. This message usually goes away in a few seconds.

Troubleshooting

If you see this on the screen:	Try this:
–	<ul style="list-style-type: none">• No program information, such as artist name, song title, or channel exists.
If this happens:	
You do not receive all the channels to which you subscribed	<ul style="list-style-type: none">• If you have not yet activated your service, refer to the Activation or Subscribe section in the User Guide which accompanied your Radio (go to siriusxm.ca/userguides).• Go to siriusxm.ca/refresh and follow the directions to refresh your Radio.• Call 1-888-539-7474 for further assistance.
No audio	<ul style="list-style-type: none">• Check all cables between your Radio and your stereo system or powered speakers for a firm and secure connection.• Ensure you have selected the proper input source on your stereo system, or try another source.• Increase the audio level of the Radio. Refer to the User Guide which accompanied your Radio for instructions (go to siriusxm.ca/userguides).
Audio sounds too soft	<ul style="list-style-type: none">• Raise the volume of your stereo system or powered speakers, or increase the audio level of your Radio until the sound quality improves. Refer to the User Guide which accompanied your Radio for instructions (go to siriusxm.ca/userguides).
No song title or artist name is displayed	<ul style="list-style-type: none">• The information may not be available or updates may be in progress.

Troubleshooting

If this happens:	Try this:
Traffic and Weather channels sound different from other channels	<ul style="list-style-type: none">• These channels use a different audio technology than other channels so they often sound different from other channels.
The Radio shuts off unexpectedly	<ul style="list-style-type: none">• If your Radio has these features, check these:<ul style="list-style-type: none">- If Sleep Timer is set, the Radio will turn off after the selected length of time in a Home Dock. Set Sleep Timer to Off.- If Delayed Power is set, the Radio will turn off after the selected length of time in the Home Dock. Set Delayed Power to Off.
The demo is playing	<ul style="list-style-type: none">• Your Indoor/Outdoor Home Antenna is not connected or you are not receiving the signal. Check that the Indoor/Outdoor Home Antenna is connected properly and is not obstructed.

Product Specifications

System

Power Requirements:	110 V AC, 200 mA (max)
Operating Temperature:	-4°F to +140°F (-20°C to +60°C)
Audio Output:	1.5 Vrms (max)

Home Dock

Dimensions:	4.1 in (W) X 1.8 in (H) X 1.7 in (D) 105 mm (W) X 45 mm (H) X 44 mm (D)
Weight (without adapter):	1.8 oz (50 g)
Weight (with adapter):	1.9 oz (54 g)
Audio Connector:	1/8 in (3.5 mm) female
Antenna Connector:	SMB male

Home Power Adapter

Input:	100-240 V AC, 50-60 Hz, 0.2 A
Output:	5.0 V DC, 1.0 A

Indoor/Outdoor Home Antenna

Type:	SiriusXM Indoor/Outdoor
Connector:	SMB female
Cable Length:	Approximately 20 ft (6.1 m)

Stereo Audio Cable

Connectors:	1/8 in (3.5 mm) stereo male to RCA left & right
Cable Length:	Approximately 5.9 ft (180 cm)

Patent and Environmental Information

Patent Information

It is prohibited to, and you agree that you will not, copy, decompile, disassemble, reverse engineer, hack, manipulate, or otherwise access and/or make available any technology incorporated in this product. The music, talk, news, entertainment, data, and other content on the Services are protected by copyright and other intellectual property laws and all ownership rights remain with the respective content and data service providers. You are prohibited from any export of the content and/or data (or derivative thereof) except in compliance with applicable export laws, rules and regulations. The user of this or any other software contained in a SiriusXM Radio is explicitly prohibited from attempting to copy, decompile, reverse engineer, hack, manipulate or disassemble the object code, or in any other way convert the object code into human-readable form.

Environmental Information

Follow local guidelines for waste disposal when discarding packaging and electronic appliances.

IC Statement

Operation is subject to the following two conditions: (1) this device may not cause interference, and (2) this device must accept any interference, including interference that may cause undesired operation of the device. For product available in the Canada market, only channel 1~11 can be operated. Selection of other channels is not possible. This device and its antenna(s) must not be co-located or operation in conjunction with any other antenna or transmitter. To reduce potential radio interference to other users, the antenna type and its gain should be so chosen that the equivalent isotropically radiated power (e.i.r.p) is not more than that permitted for successful communication. IC Radiation Exposure Statement: This equipment complies with IC RSS-102 radiation exposure limits set forth for an uncontrolled environment. This equipment should be installed and operated with minimum distance 20cm between the radiator & your body.

WARNING! The FCC and FAA have not certified this Satellite Radio Receiver for use in any aircraft (neither portable nor permanent installation). Therefore, SiriusXM cannot support this type of application or installation.

Copyrights and Trademarks

© 2016 Sirius XM Canada Inc. "SiriusXM", the SiriusXM logo, channel names and logos are trademarks of Sirius XM Radio Inc. and are used under license. "NFL" and the NFL Shield design are trademarks of the National Football League. NASCAR® is a registered trademark of the National Association for Stock Car Auto Racing, Inc. The NBA and NBA member team identifications are the intellectual property of NBA Properties, Inc. and the respective NBA member teams. © 2016 NBA Properties, Inc. All rights reserved. NHL and the NHL Shield are registered trademarks of the National Hockey League. © NHL 2016. Elvis Radio logo © EPE Reg. U.S. Pat & TM off. CFL® is a registered trademark of the Canadian Football League. All other trademarks, service marks, images and logos are property of their respective owners and are used with permission. All Rights Reserved. Required subscription sold separately. Pricing and programming is subject to change. Premier subscription required for some channels. See Customer Agreement for complete terms at siriusxm.ca.

Indoor/Outdoor Home Antenna Template

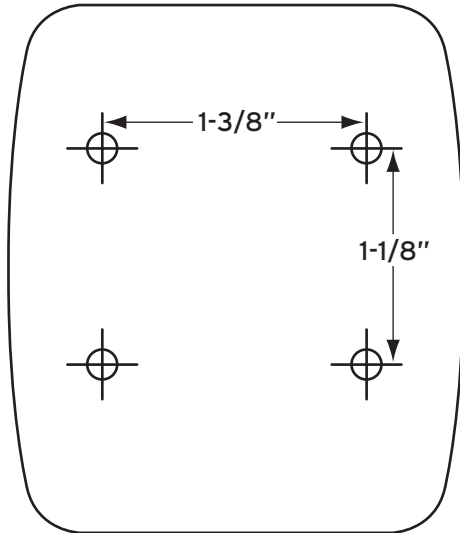

siriusxm.ca

**Sirius XM Canada Inc.
135 Liberty St. - 4th floor
Toronto, Ontario, M6K 1A7**

1-888-539-7474

© 2016 Sirius XM Canada Inc.

SXDH3UG E 160210a