



User Guide

Universal Vehicle Kit

Table of Contents

| | |
|---|-----------|
| Compatibility | 3 |
| Introduction | 4 |
| Features | 4 |
| Safety and Care Information | 5 |
| What's in the Box? | 7 |
| PowerConnect Vehicle Dock | 8 |
| Vehicle Installation | 10 |
| Step 1: Insert the Radio Dock Adapter Into the Dock | 10 |
| Step 2: Choose a Location for Your Radio | 13 |
| Step 3: Install the Dash or Vent Mount | 16 |
| Step 4: Mount the Magnetic Mount Antenna | 19 |
| Step 5: Route the Magnetic Mount Antenna Cable | 25 |
| Step 6: Connect the Magnetic Mount Antenna and PowerConnect Power Adapter ... | 36 |
| Step 7: Connect the Audio | 37 |
| Troubleshooting | 46 |
| Product Specifications | 50 |
| Patent and Environmental Information | 51 |
| Patent Information | 51 |
| Environmental Information | 51 |
| IC Statement | 52 |
| Copyrights and Trademarks | 53 |

Compatibility

This Universal Vehicle Kit is compatible with the following Dock & Play Radios:

SiriusXM:

- Onyx Plus
- Edge

XM:

- Onyx
- Onyx EZ
- XpressRCi
- XpressRC
- XpressR

Sirius:

- Sportster 5
- Starmate 8, 5, 4, 3
- Stratus 7, 6, 5
- Stratus

Introduction

Features

Thank you for purchasing the Universal Vehicle Kit!

Your Universal Vehicle Kit has everything you need to use your compatible SiriusXM Dock & Play Radio in another vehicle.

- Add Satellite Radio to an additional vehicle: No need for a second subscription. Just install this kit in another vehicle - your spouse's car, the family minivan, an RV, or even a boat - and then simply move your Radio between the two.
- Easy to install: Hear SiriusXM through your existing vehicle radio* with easy, do-it-yourself installation. The color-coded Vehicle Dock makes it simple to connect.

For the latest information about this and other SiriusXM products and accessories, visit siriusxm.ca or your favorite retailer.

Please read this entire User Guide before installing the Universal Vehicle Kit!

*FM radio required. If your vehicle has an Aux Input, use the included Aux In Cable for best performance. It will also work with a Cassette Adapter (sold separately).

Introduction

Safety and Care Information



IMPORTANT! Self installation instructions and tips are provided for your convenience. It is your responsibility to determine if you have the knowledge, skills, and physical ability required to properly perform an installation. SiriusXM shall have no liability for damage or injury resulting from the installation or use of any SiriusXM or third party products. It is your responsibility to ensure that all products are installed in adherence with local laws and regulations and in such a manner as to allow a vehicle to be operated safely and without distraction. SiriusXM product warranties do not cover the installation, removal or reinstallation of any product.

- Do not expose to extreme temperatures (above 140°F or below -4°F, or above 60°C or below -20°C).
- Do not expose to moisture. Do not use device near or in water. Do not touch the device with wet hands.
- Do not let any foreign matter spill into device.
- Do not store in dusty areas.
- Do not expose to chemicals such as benzene and thinners. Do not use liquid or aerosol cleaners. Clean with a soft damp cloth only.
- Do not expose to direct sunlight for a prolonged period of time, and do not expose to fire, flame, or other heat sources.
- Do not try to disassemble and/or repair device yourself.
- Do not drop your device or subject it to severe impact.
- Do not place heavy objects on device.
- Do not subject device to excessive pressure.

Introduction

WARNING!

- Opening the case may result in electric shock.
- Make sure that you insert the *PowerConnect* Power Adapter's plug all the way into the vehicle's cigarette lighter or power adapter socket.
- If you are using *PowerConnect* as your audio connection option, it is advisable not to insert a multi-outlet adapter into the same vehicle cigarette lighter or power adapter socket to simultaneously power other devices. Some multi-outlet adapters can prevent the *PowerConnect* feature from working properly.
- When using this product, it is always important to keep your eyes on the road and hands on the wheel. Not doing so could result in personal injury, death, and/or damage to your device, accessories, and/or to your vehicle or other property.
- Vehicle installation, service activation, and Radio configuration functions should not be performed while driving. Park your vehicle in a safe location before beginning installation.
- This product contains chemicals known to the State of California to cause cancer and birth defects or other reproductive harm.

Your device should be placed in your vehicle where it will not interfere with the function of safety features, e.g., deployment of airbags. Failure to correctly place device may result in injury to you or others, if the unit becomes detached during an accident and/or obstructs the deployment of an airbag.

Introduction

What's in the Box?

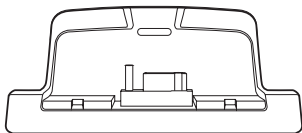

PowerConnect™ Vehicle Dock

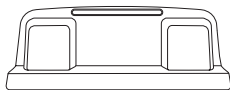

XM & SiriusXM
Radio Dock Adapter

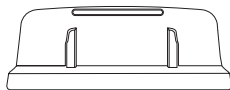

Sirius
Radio Dock Adapter



Aux In Cable

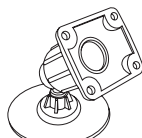

Dash Mount

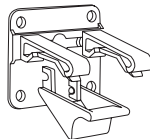
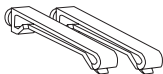

Vent Mount and
Extended Vent Clamps

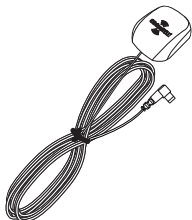

Magnetic Mount
Antenna

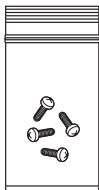

Screws (4)

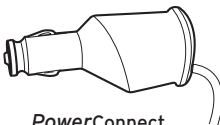

PowerConnect
Power Adapter



Alcohol
Preparation Pads



TIP! For other accessories you can add to your Vehicle Kit - from a Remote Control for ease of use, to a Cassette Adapter for vehicles with a cassette player, to professional installation if you'd rather leave your in-vehicle setup to the experts - just visit siriusxm.ca or your favorite retailer.

Introduction

PowerConnect Vehicle Dock

Color-Coded Connections

The color-coded *PowerConnect* Vehicle Dock makes it simple to connect. Just match the colors on the cable ends to the colors on the dock to see what goes where.

Side View

Right

Left

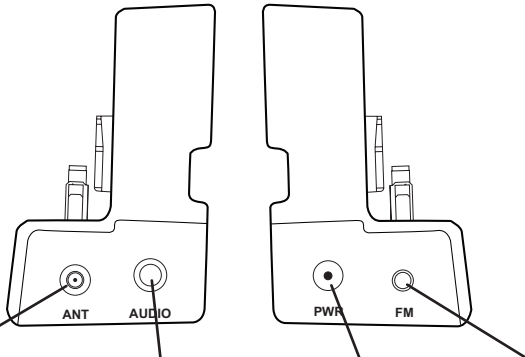

ANT (Silver)
Connection for the Magnetic Mount Antenna.

AUDIO (Green)
Connection for Aux In Cable or optional Cassette Adapter (sold separately).

PWR (Red)
Connection for *PowerConnect* Power Adapter.

FM (Blue)
Connection for optional FM Direct Adapter (sold separately).

Introduction

Wire Guide

The *PowerConnect* Vehicle Dock has a channel across the back to help organize the wires connected to the dock. If you need to bring a wire from one side of the dock to the other side, utilize the wire guide channel to keep the wires tidy.

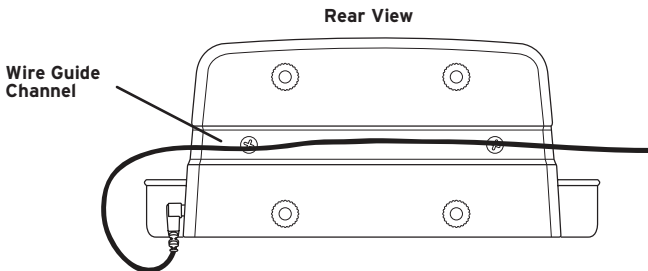

Vehicle Installation

Step 1: Insert the Radio Dock Adapter Into the Dock

You'll need to insert the Radio Dock Adapter that is compatible with your Radio into the Vehicle Dock.

1. Locate the Radio Dock Adapter that is compatible with your Radio.

If you have an XM or SiriusXM Radio: If your Radio is branded as **XM*** or **SiriusXM***, select the Radio Dock Adapter marked **XM & SIRIUSXM** on the back of the adapter.



Back View

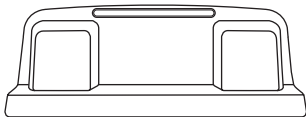

Front View Correct Orientation

If you have a Sirius Radio: If your Radio is branded as **Sirius***, select the Radio Dock Adapter that is marked **SIRIUS** on the back of the adapter.

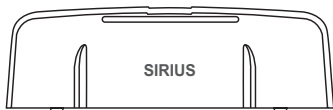

Back View

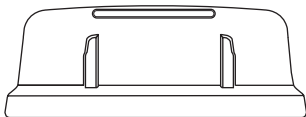

Front View Correct Orientation

*If you are unsure whether your Radio is an XM, SiriusXM, or Sirius Radio, check the label on the back of the Radio. If the label on your Radio says XM Radio ID or Radio ID, and has an 8-digit alphanumeric number, it is an XM or SiriusXM Radio. If the label on your Radio says Sirius ID, SID, or ESN, and has a 12-digit numeric number, it is a Sirius Radio.

Vehicle Installation

- 2.** Orient and place the Radio Dock Adapter that you selected into the Vehicle Dock. Be sure the adapter is centered, and is seated all the way down into the dock.

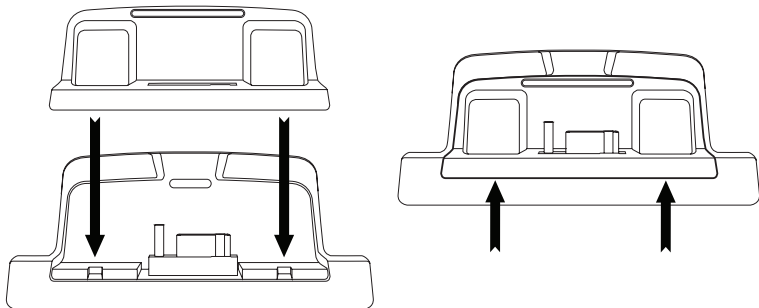

- 3.** Once the adapter is seated correctly in the Vehicle Dock, gently press the top of the adapter against the dock with your finger until it clicks into place. The Radio Dock Adapter is now installed.

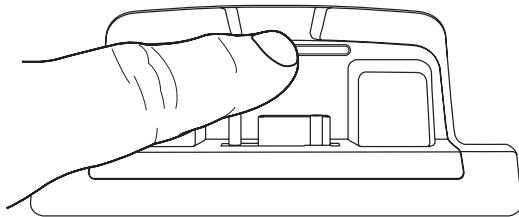

Should it become necessary to remove the Radio Dock Adapter from the Vehicle

Vehicle Installation

Dock, use your fingernail to gently press down on the top of the adapter, and then use a long thin object such as a paper clip, a screw driver, or something similar to pry the adapter away until it releases from the dock. Then lift the adapter up and out of the dock.

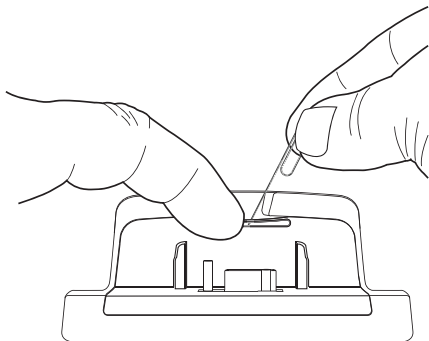

Vehicle Installation



WARNING! DO NOT attempt to install this Vehicle Kit while driving. Park your vehicle in a safe location before beginning installation.

Step 2: Choose a Location for Your Radio

When installing the *PowerConnect* Vehicle Dock in your vehicle, choose a location where it will not block your vision, interfere with the controls, or obstruct the air bag. The location should be easily accessible and provide good visibility of the display, and should not be located where it may be in direct sunlight, which will affect the visibility of the display screen.

Depending on your preference, you can either choose to use the Dash Mount or the Vent Mount. On the following two pages, several examples of the *PowerConnect* Vehicle Dock and Radio mounted in a vehicle are shown: **A** is the on dash method using the Dash Mount, and **B** is the vent clip method using the Vent Mount. You may want to read the installation instructions for each type of mount in step 3 to help you select which mount you will use.



NOTE: Your Radio may be a different model than the Radio shown here.

Vehicle Installation

Option 1 - Dash Mount

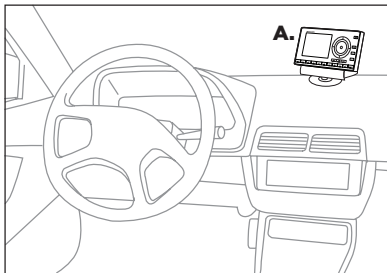

Option 2 - Dash Mount

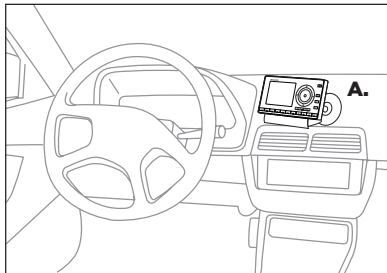

Option 3 - Dash Mount

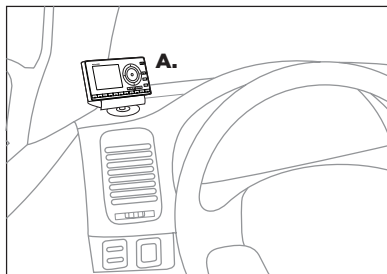

Option 4 - Dash Mount

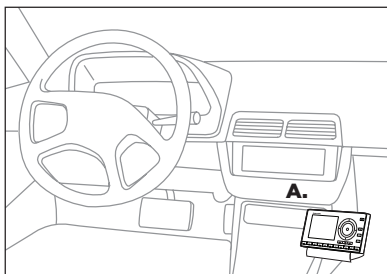

Vehicle Installation

Option 5 - Vent Mount

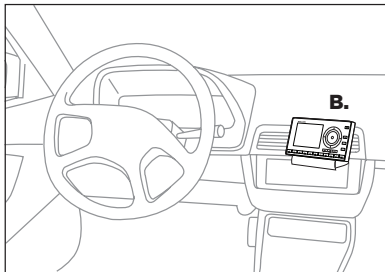

Option 6 - Vent Mount

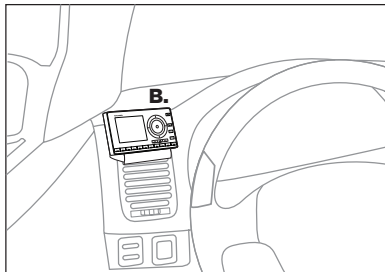

Vehicle Installation

Step 3: Install the Dash or Vent Mount

Follow the instructions on the next several pages for the mounting method you have selected.



NOTE! The PowerConnect Vehicle Dock included with this Vehicle Kit is compatible with the T-slot style Dash and Vent Mounts. If you have an existing Dash Mount or Vent Mount in your vehicle, you can continue to use it with this dock, and skip this step.

Installing the Dash Mount:



CAUTION! The adhesive used on the Adhesive Mount may be difficult to remove. Do not install this mount on leather surfaces (contact your automobile dealership if you are unsure about your dash surface), and make sure the air temperature is at least 60°F (15°C) during installation. If it's not at least 60°F, turn on the heater in your vehicle to bring the temperature up to 60°F.

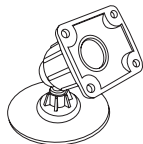

1. Locate a flat surface for the Adhesive Mount. Make sure there is ample room for the PowerConnect Vehicle Dock and Radio when installed.
2. Set the orientation of the Adhesive Mount before adhering it. Loosen the knob and adjust the adhesive foot for the location you selected in "Step 2: Choose a Location for Your Radio" on page 13.

Option 1
Option 3

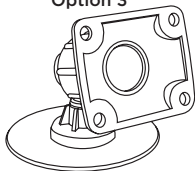

Option 2

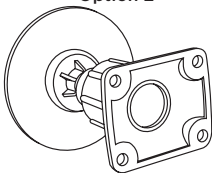

Option 4

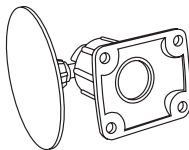

3. The dock mounting plate can be tilted in different directions. Adjust as

Vehicle Installation

necessary for your particular vehicle. When the orientation is correct, tighten the knob.

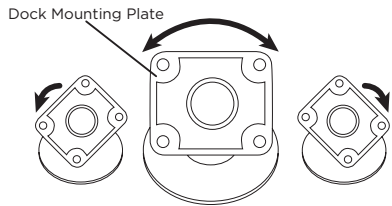
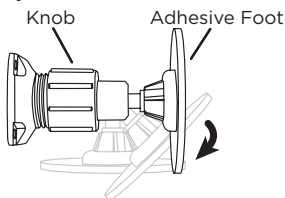

4. Attach the Adhesive Mount to the *PowerConnect* Vehicle Dock using the 4 provided screws. If you plan to use the wire guide channel across the back of the Vehicle Dock to organize the wires, do not fully tighten the screws. If not, tighten the screws.

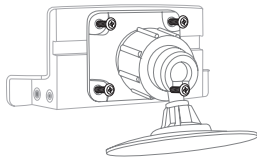

5. Once the cables have been attached to the dock, clean the mounting surface in the vehicle with the alcohol preparation pad and let it dry thoroughly.
6. Peel off the adhesive liner. Position, press, and hold the Adhesive Mount in place for 30 seconds.



IMPORTANT! Allow the Adhesive Mount adhesive to cure (dry) for a minimum of 2-4 hours before using the mount. The best adhesion occurs after 24 hours.



TIP! To remove the Adhesive Mount, carefully lift the adhesive pad with your fingers or a spoon. Warming the pad with a hair dryer for several minutes will help soften the adhesive.

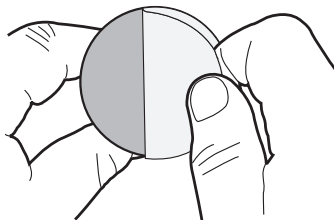

Vehicle Installation

Installing the Vent Mount:



IMPORTANT! To make the cable connections easier, wait until after you have connected all the cables to the dock before you attach the Vent Mount to a vent.

1. Locate a vent with horizontal louvers sturdy enough to hold your *PowerConnect* Vehicle Dock and Radio.
2. If the vent louvers in your vehicle are recessed, you may need to use the longer vent clamps with the Vent Mount. If so, remove the shorter vent clamps and install the longer ones into the Vent Mount. Be sure to observe the orientation of the vent clamps as shown, and replace both vent clamps.

Extended Vent Clamps

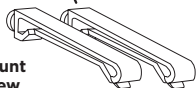

Vent Mount Rear View

Short Vent Clamps

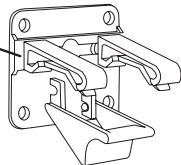

Vent Mount Rear View

Slide Left Clamp to Hole in Center

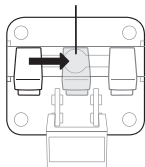

Pull Clamp Out Towards You

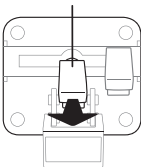

Insert Round End of the Extended Clamp in the Center Hole

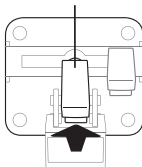

Slide Clamp to Left to Complete Installation

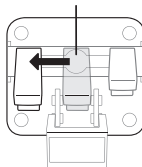

Repeat to Replace Right Clamp

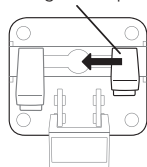

Round End →  ← Orientation

Vehicle Installation

3. Attach the Vent Mount to the PowerConnect Vehicle Dock using the 4 provided screws. If you plan to use the wire guide channel across the back of the Vehicle Dock to organize the wires, do not fully tighten the screws. If not, tighten the screws.

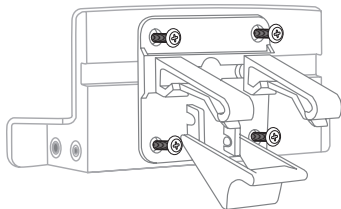

Note! For greater clarity, the next illustration does not show the dock attached to the Vent Mount, however, the dock should be attached before continuing.

4. Once the cables have been attached to the dock, push the Vent Mount onto the vehicle vent as shown (1) until it hooks on the rear of the vent louver (2).
5. Rest the foot against the bottom of the vent (2), and adjust the tilt of the Vent

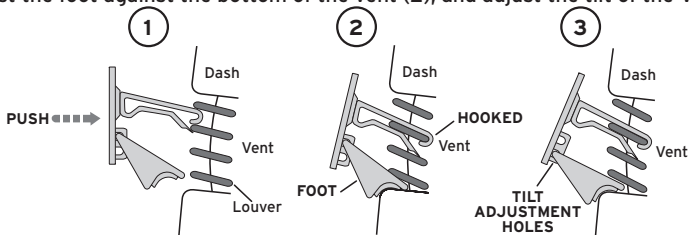

Mount by repositioning the foot to the other adjustment hole (3).



TIP! To remove the Vent Mount, push the mount into the vent. Then lift up until disengaged from the rear of the vent louver, and remove the Vent Mount.

Vehicle Installation

Step 4: Mount the Magnetic Mount Antenna

Mount the Magnetic Mount Antenna on the outside of your vehicle, on a horizontal surface that will always face the sky. The antenna contains a strong magnet which will stick to any metal part of your vehicle, but will not damage the vehicle.

To install the Magnetic Mount Antenna:

1. Choose the best location for the antenna considering your vehicle type. Pay particular attention to any accessories that you may have like luggage racks and how frequently you may use them.

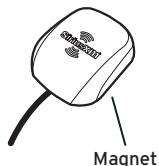

Sedan/Coupe: We recommend mounting the antenna just above either the front windshield or the back window as shown.

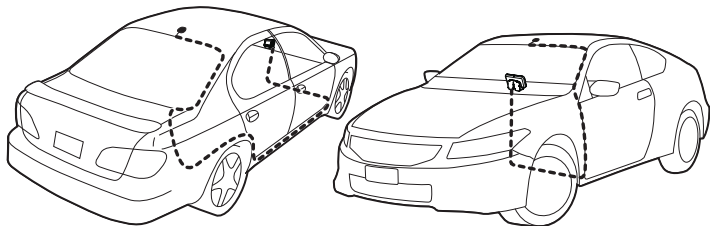

Vehicle Installation

SUV: We recommend mounting the antenna at the rear of the roof as shown.

Convertible: We recommend mounting the antenna at the leading edge of the trunk as shown.

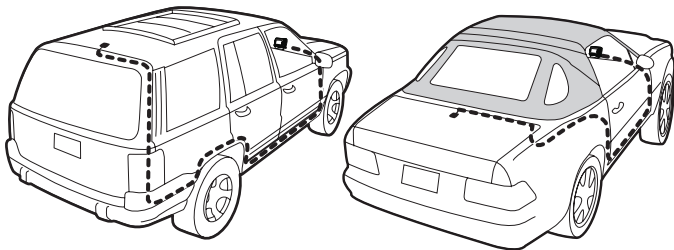

Pickup Truck: We recommend mounting the antenna just above the front windshield as shown.



IMPORTANT! Consult a professional installer if your vehicle roof or hood is non-metallic (i.e., fiberglass), or you have difficulty finding a location for your antenna.

2. Clean the surface of the selected mounting location using the alcohol preparation pad and let it dry thoroughly.

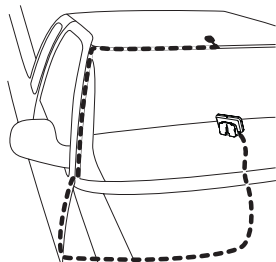

Vehicle Installation

3. Place the antenna in the location you selected. Follow the Tips and Cautions shown on the next several pages.

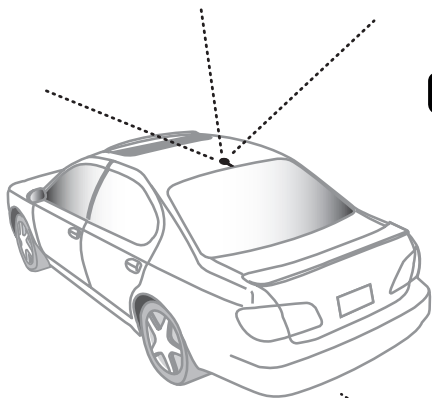

TIP! Mount the antenna on the roof (for most vehicles) or trunk (for convertibles) where it has a clear view of the sky in all directions.

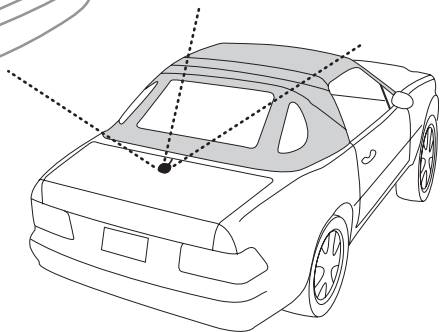

Vehicle Installation



CAUTION! Don't mount the antenna inside the vehicle, for example, on the dashboard.

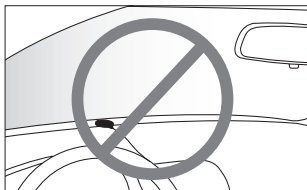

CAUTION! Don't mount the antenna on any of the vehicle's front, back or side pillars.

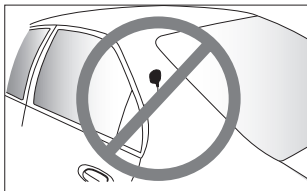

CAUTION! Don't mount the antenna close to a roof rack. Adjust the rack so it's further away from the antenna or move the antenna closer to the center of the roof.

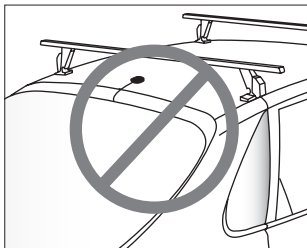

Vehicle Installation



CAUTION! Don't mount the antenna close to another antenna. Mount it at least 3 inches away.

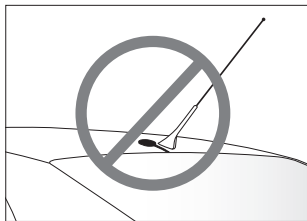

Vehicle Installation

Step 5: Route the Magnetic Mount Antenna Cable

Before you begin routing the antenna cable, read these general instructions for how to route and hide the antenna cable. Then route your antenna cable according to the instructions which follow for your specific type of vehicle.

Use a blunt plastic putty knife, a credit card, a plastic knife, or a similar blunt tool to lift the rubber window moulding

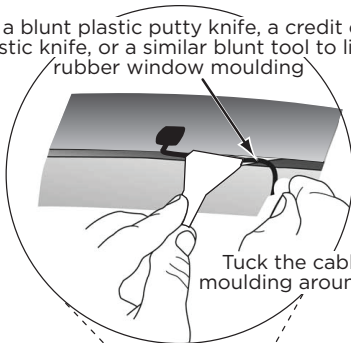

Tuck the cable under the moulding around the window

Feed cable under rubber moulding around window

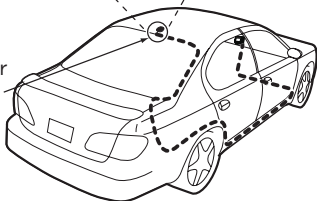

Vehicle Installation

Route cable out from under rear windshield moulding and tuck into weatherstripping around trunk opening

Avoid sharp bends by running cable through weatherstripping for several inches



Pull weatherstripping from trunk opening



Tuck cable into weatherstripping. Route cable through weatherstripping several inches to avoid sharp bends

Pull cable out of weatherstripping and route through trunk to cabin

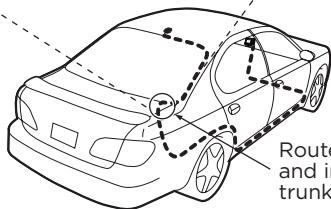
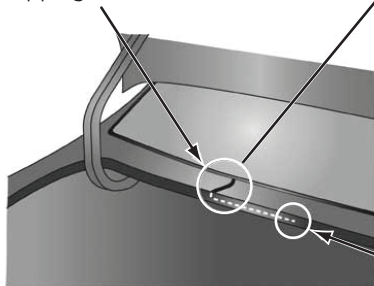

Route cable out of window moulding and into weatherstripping around trunk opening

Vehicle Installation

Bring cable out of weatherstripping and into trunk

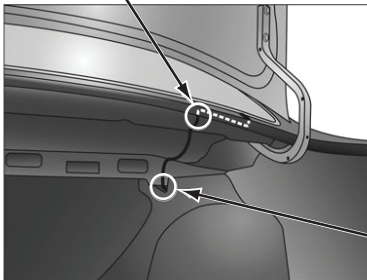

Route cable along trunk wall and into cabin through gap or conduit, along existing wiring harness

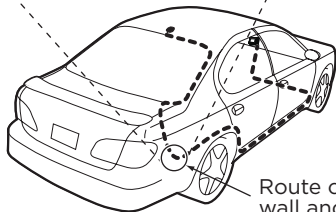

Route cable along trunk wall and into cabin

Vehicle Installation

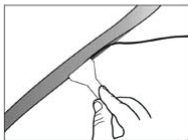

Use a blunt plastic putty knife or similar blunt tool to lift edge of interior trim and tuck cable under trim. Continue towards front of vehicle

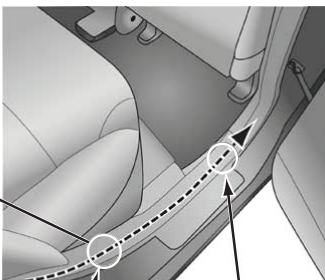

Route cable under trim or upholstery

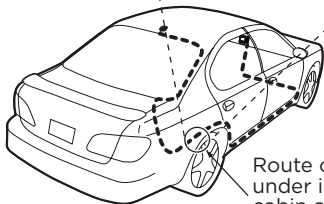

Route cable from trunk under interior trim, into cabin and towards front of vehicle

Continue routing cable under trim or carpet towards front of vehicle

Vehicle Installation

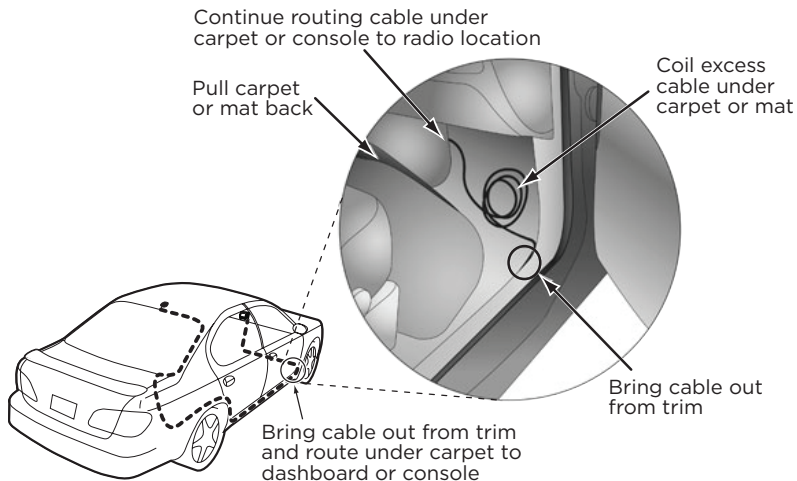

TIP! Always be careful to include enough slack in your cable to accommodate open doors or trunk lids. Use things typically found around the home, like electrical tape, to secure cables in areas so that hinges do not pinch the cable with the door. Hide any excess cable in the trim.

Vehicle Installation

Sedan/Coupe With the Antenna Placed at the Rear of the Roof:

1. Feed the antenna cable from the antenna underneath the rubber molding around the rear window. Use a blunt plastic putty knife or similar blunt tool to lift the rubber molding around the rear window and tuck the antenna cable underneath the molding. Route the antenna cable around and down the window to the lowest point. If your rear window does not have rubber molding, we recommend consulting a professional installer.
2. Route the antenna cable out of the window molding and into the rubber weather stripping around the trunk opening. Lift the weather stripping from the opening and tuck the cable inside it, then replace the weather stripping. To avoid sharp bends in the cable, run the cable inside the weather stripping for a few inches, then remove the cable from the weather stripping inside the trunk. Keep the cable away from hinges, gears, etc., that could damage it.
3. Route the cable out from the rubber weather stripping and along the trunk wall. Continue routing the cable into the vehicle cabin through a conduit or along an existing wiring harness.
4. Route the cable through the main cabin area under the interior trim, towards the front of the vehicle. Use a blunt plastic putty knife or similar blunt tool to lift the plastic trim just enough to tuck the cable underneath. Avoid side airbag locations on back pillars and above the doors. Airbag locations are marked with "SRS" logos. Be careful not to crimp or cut the cable.

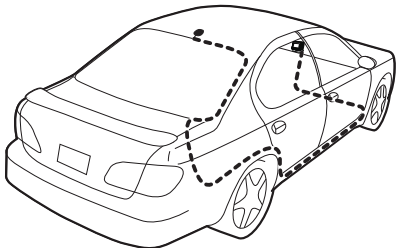

Vehicle Installation

- 5.** Bring the cable out from the trim near the front of the cabin and route it under the carpet toward the dashboard or console. Coil any excess cable in a hidden location, such as under the carpet, keeping it away from any vehicle pedals or controls. Secure the excess cable with wire ties (purchased separately).
- 6.** Bring the end of the cable out at the *PowerConnect* Vehicle Dock location. Leave yourself enough cable so you can easily connect it to the antenna connector of the dock.
- 7.** Continue with “Step 6: Connect the Magnetic Mount Antenna and *PowerConnect* Power Adapter” on page 36.

Vehicle Installation

Sedan/Coupe With the Antenna Placed at the Front of the Roof:

1. Feed the antenna cable from the antenna underneath the rubber molding around the windshield. Use a blunt plastic putty knife or similar blunt tool to lift the rubber molding around the windshield and tuck the antenna cable underneath the molding. Route the antenna cable around and down the windshield to the lowest point.
2. At the lowest corner of the windshield, route the cable out of the windshield molding and into the rubber weather stripping around the door opening. Lift the weather stripping from the opening and tuck the cable inside it, then replace the weather stripping. Run the cable inside of the weather stripping to the bottom of the door opening.
3. Pull the cable out of the weather stripping at the bottom of the door opening and route it under the carpet toward the dashboard. Coil any excess cable in a hidden location, such as under the carpet, keeping it away from any vehicle pedals or controls. Secure the excess cable with wire ties.
4. Bring the end of the cable out at the *PowerConnect Vehicle Dock* location. Leave yourself enough cable so you can easily connect it to the antenna connector of the dock.
5. Continue with "Step 6: Connect the Magnetic Mount Antenna and *PowerConnect Power Adapter*" on page 36.

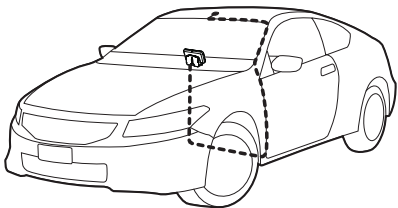

Vehicle Installation

SUV:

1. Feed the antenna cable underneath the rubber weather stripping of the rear tailgate window/door and route the cable along the rear hatch. Lift the weather stripping from the opening and tuck the cable inside it, then replace the weather stripping. Pull the cable out from weather stripping and route it into the cabin under the interior trim. Avoid hinges or gears that could crimp or cut the cable.
2. Route the cable through the SUV's main cabin area under the interior trim, towards the front of the vehicle. Use a blunt plastic putty knife or similar blunt tool to lift the plastic trim just enough to tuck the cable under underneath. Avoid side airbag locations on back pillars and above the doors. Airbag locations are marked with "SRS" logos. Be careful not to crimp or cut the cable.
3. Bring the cable out from the trim near the front of the cabin and route it under the carpet toward the dashboard or console. Coil any excess cable in a hidden location, such as under the carpet, keeping it away from any vehicle pedals or controls. Secure the excess cable with wire ties (purchased separately).
4. Bring the end of the cable out at the *PowerConnect Vehicle Dock* location. Leave yourself enough cable so you can easily connect it to the antenna connector of the dock.
5. Continue with "Step 6: Connect the Magnetic Mount Antenna and *PowerConnect Power Adapter*" on page 36.

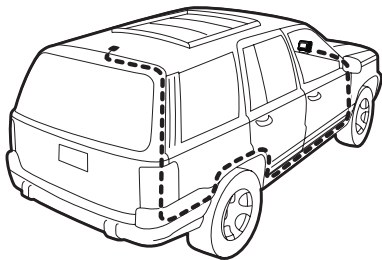

Vehicle Installation

Convertible:

1. Bring the antenna cable from the antenna into the trunk at the front edge of the trunk lid. Keep any bends in the cable loose. Tape or tie the cable along the inside of the trunk lid to the trunk lid hinge strut.
2. Allow enough slack in the cable so the trunk lid can easily open and close and keep the cable away from hinges, gears, etc., that could crimp or cut it. Route the cable along the trunk wall and into the cabin through a conduit or along an existing wiring harness.
3. Route the cable through the main cabin area under the interior trim, towards the front of the vehicle. Use a blunt plastic putty knife or similar blunt tool to lift the plastic trim just enough to tuck the cable under underneath. Avoid side airbag locations on back pillars and above the doors. Airbag locations are marked with "SRS" logos. Be careful not to crimp or cut the cable.
4. Bring the cable out from the trim near the front of the cabin and route it under the carpet toward the dashboard or console. Coil any excess cable in a hidden location, such as under the carpet, keeping it away from any vehicle pedals or controls. Secure the excess cable with wire ties (purchased separately).
5. Bring the end of the cable out at the *PowerConnect Vehicle Dock* location. Leave yourself enough cable so you can easily connect it to the antenna connector of the dock.
6. Continue with "Step 6: Connect the Magnetic Mount Antenna and *PowerConnect Power Adapter*" on page 36.

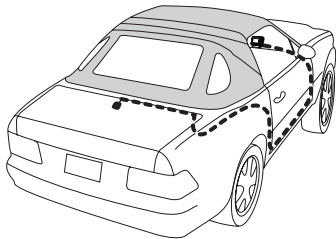

Vehicle Installation

Pickup Truck:

1. Use a blunt plastic putty knife or similar blunt tool to lift the rubber molding around the windshield and tuck the antenna cable underneath it.
2. Continue tucking the cable underneath the windshield molding around the windshield to the lowest corner.
3. At the lowest corner of the windshield, route the cable out of the windshield molding and into the rubber weather stripping around the door opening. Lift the weather stripping from the opening and tuck the cable inside it, then replace the weather stripping. Run the cable inside of the weather stripping to the bottom of the door opening.
4. Pull the cable out of the weather stripping at the bottom of the door opening and route it under the carpet toward the dashboard. Coil any excess cable in a hidden location, such as under the carpet, keeping it away from any vehicle pedals or controls. Secure the excess cable with wire ties.
5. Bring the end of the cable out at the *PowerConnect* Vehicle Dock location. Leave yourself enough cable so you can easily connect it to the antenna connector of the dock.
6. Continue with "Step 6: Connect the Magnetic Mount Antenna and *PowerConnect* Power Adapter" on page 36.

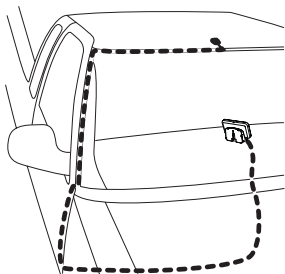

Vehicle Installation

Step 6: Connect the Magnetic Mount Antenna and PowerConnect Power Adapter

1. Plug the Magnetic Mount Antenna into the **silver ANT** connector at the side of the *PowerConnect* Vehicle Dock.

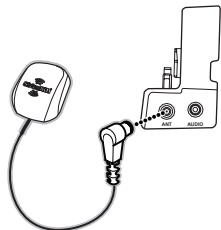

2. Insert the *PowerConnect* Power Adapter into your vehicle's cigarette lighter or power adapter socket.

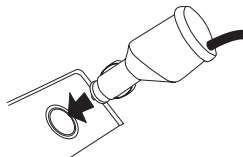

3. Plug the *PowerConnect* Power Adapter into the **red PWR** connector at the side of the *PowerConnect* Vehicle Dock.

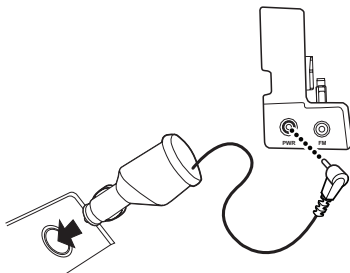

Vehicle Installation

Step 7: Connect the Audio

To play audio through your vehicle's stereo or FM radio, decide on one of the following audio connection options:

- **Option 1: Best:** Use the provided **Aux In Cable** if your vehicle's stereo system has an auxiliary input connection or jack. Refer to your vehicle's owners manual to find the location of the auxiliary input jack, or consult the vehicle dealer.



TIP! The auxiliary input jack may be located on the face plate of the vehicle radio, on the back of the radio, anywhere on the front dash panel, inside the glove compartment, or inside the center console in between the front seats.

- **Option 2: Better:** Use a **Cassette Adapter** if your vehicle has a built-in cassette player. Cassette Adapters are sold separately and can be purchased from an electronics retailer, or go to shop.sirius.ca.
- **Option 3: Good:** Use the **PowerConnect** feature in your Radio. *PowerConnect* plays the audio through your vehicle's FM radio.
- **Option 4: Best:** Use the **FM Direct Adapter**. If none of the previous three audio connection options will work in your vehicle, then you will need to use the FM Direct Adapter (FMDA) (sold separately). The FMDA needs to be installed by a professional installer and directly connects the Radio to your vehicle's FM radio. To learn more, check with the retailer where you bought your Radio, or go to shop.sirius.ca.

Follow the installation instructions in the next several sections for the audio connection option that you have selected.

Vehicle Installation

Option 1: Aux In Cable Installation Instructions

1. Plug one end of the Aux In Cable into the **green AUDIO** connector at the side of the *PowerConnect Vehicle Dock*.

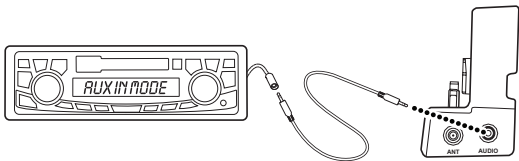

2. Plug the other end into the auxiliary input jack connection of your vehicle's stereo system.
3. If you are using the vent mounting method, attach the Vent Mount to the vent.
4. Insert your Radio into the dock.



NOTE: Your Radio may be a different model than the Radio shown here.

5. Be sure the vehicle is outside and the antenna has a clear view of the sky.
6. Power on your Radio by pressing the **Power button**.
7. Be sure the vehicle is outside and the antenna has a clear view of the sky. Verify that you are receiving the satellite signal. There should at least be two bars on the main display screen that denotes antenna signal strength. You can also refer to your Radio's User Guide (go to siriusxm.ca/userguides) for instructions on accessing the **Signal Indicator**, **Signal**, or **Antenna Aiming** screen of your Radio, to see a visual indication of signal strength.

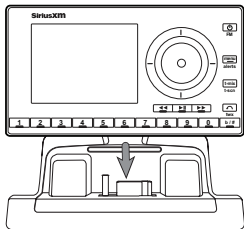

Vehicle Installation

The Satellite and Terrestrial bars show the strength of the signal being received. If the signal reception is good, exit the Antenna Aiming or Signal Indicator screen and continue with step 8.

8. Turn on your vehicle's stereo system. Set it to play input from the auxiliary input source. You should hear the audio through your vehicle's stereo system. The aux in cable installation is complete.
9. The audio level output of the Radio can be increased or decreased as necessary to match the audio levels of other sources in your vehicle. Refer to your Radio's User Guide (go to siriusxm.ca/userguides) for instructions.
10. If you are using the wire guide channel across the back of the Vehicle Dock to organize the wires, place the wires in the guide and then tighten the 4 screws to securely attach the mount. Then the installation is complete.

If the signal reception is good, showing at least two bars of antenna signal strength, but there is no audio, be sure the vehicle's stereo system is set to the auxiliary input source (step 8). Also be sure that the audio level is set high enough to be heard (step 9). Refer to "Troubleshooting" on page 46 for additional help.

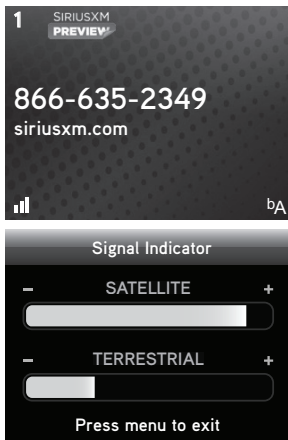

*The screens shown above are representative and may differ from the screens displayed on your Radio.

Vehicle Installation

Option 2: Cassette Adapter Installation Instructions

1. Plug the Cassette Adapter into the **green AUDIO** connector at the side of the PowerConnect Vehicle Dock.

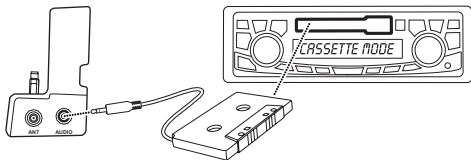

2. Insert the Cassette Adapter into the vehicle's cassette deck. You may need to turn on your vehicle's stereo system in order to do so.
3. If you are using the vent mounting method, attach the Vent Mount to the vent.
4. Insert your Radio into the dock.

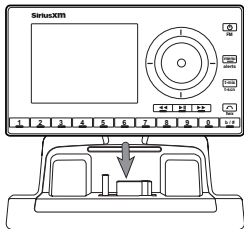

NOTE: Your Radio may be a different model than the Radio shown here.

5. Be sure the vehicle is outside and the antenna has a clear view of the sky.
6. Power on your Radio by pressing the **Power button**.
7. Be sure the vehicle is outside and the antenna has a clear view of the sky. Verify that you are receiving the satellite signal. There should be at least two bars on the main display screen that denotes antenna signal strength. You can also refer to your Radio's User Guide (go to siriusxm.ca/userguides) for instructions on accessing the **Signal Indicator**, **Signal**, or **Antenna Aiming** screen of your Radio, to see a visual indication of signal strength.

Vehicle Installation

The Satellite and Terrestrial bars show the strength of the signal being received. If the signal reception is good, exit the Antenna Aiming or Signal Indicator screen and continue with step 8.

8. If you haven't done so, turn on your vehicle's stereo system. Set it to play input from the cassette source. You should hear the audio through your vehicle's stereo system. The cassette adapter installation is complete.
9. The audio level output of the Radio can be increased or decreased as necessary to match the audio levels of other sources in your vehicle. Refer to your Radio's User Guide (go to siriusxm.ca/userguides) for instructions.
10. If you are using the wire guide channel across the back of the Vehicle Dock to organize the wires, place the wires in the guide and then tighten the 4 screws to securely attach the mount. Then the installation is complete.

If the signal reception is good, showing at least two bars of antenna signal strength, but there is no audio, be sure the vehicle's stereo system is set to the cassette source (step 8). Also be sure that the audio level is set high enough to be heard (step 9). Refer to "Troubleshooting" on page 46 for additional help.

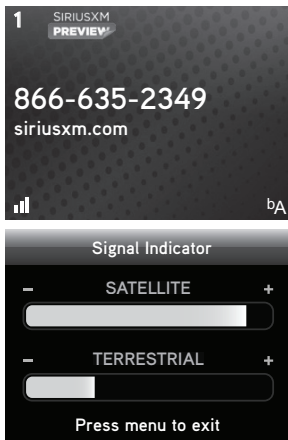

*The screens shown above are representative and may differ from the screens displayed on your Radio.

Vehicle Installation

Option 3: *PowerConnect* Installation Instructions

1. If you are using the vent mounting method, attach the Vent Mount to the vent.
2. Insert your Radio into the dock.



NOTE: Your Radio may be a different model than the Radio shown here.

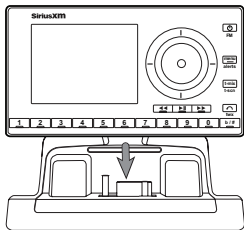

3. Be sure the vehicle is outside and the antenna has a clear view of the sky.
 4. You'll first need to find an available FM channel.
An available FM channel is one that's not being used by an FM radio station in your area. When you tune your FM radio to an available channel, you should only hear static or silence - not talk or music. We recommend one of the following methods to find an available FM channel:
 - a. Use the SiriusXM FM Channel Finder at siriusxm.ca/fm. Go to the website and enter your zip code. The Channel Finder will suggest a list of available FM channels in your area. For convenience, write down or print out the list.OR
 - b. Manually tune through your local FM channels on your vehicle's FM radio. Locate and create a list of channels that aren't being used by any FM radio station. Write down the list. Once you have created your list of available FM channels, you will need to find the one that provides the best match for your Radio.
- TIP!** You'll need to use the 'Manual' tune function on your vehicle's FM radio to tune through every FM channel one-by-one. Turn on your vehicle's FM radio. Start at 88.1 and use the 'Manual' tune function on your vehicle's FM radio to tune through each FM channel one-by-one (88.1 followed by 88.3 etc.) to locate channels that aren't being used by a local FM radio station. Write down each FM

Vehicle Installation

channel that has only static or silence on it, until you reach 107.9.

- Pick the first FM channel on your list from step 4. Turn on your vehicle's FM radio (if you have not already done so) and tune it to this FM channel. You should only hear static or silence. If not, try the next FM channel on your list.
- Power on your Radio by pressing the **Power button**.
- Be sure the vehicle is outside and the antenna has a clear view of the sky. Verify that you are receiving the satellite signal. There should at least be two bars on the main display screen that denotes antenna signal strength. You can also refer to your Radio's User Guide (go to siriusxm.ca/userguides) for instructions on accessing the **Signal Indicator**, **Signal**, or **Antenna Aiming** screen of your Radio, to see a visual indication of signal strength. The Satellite and Terrestrial bars show the strength of the signal being received. If the signal reception is good, exit the Antenna Aiming or Signal Indicator screen and continue with step 8.
- Set your satellite Radio to transmit on the same FM channel that you have selected in step 5. You may need to turn On the FM Transmitter in your Radio first. Refer to your Radio's User Guide (go to siriusxm.ca/userguides) for instructions.
- You should hear the SiriusXM audio through your vehicle's FM radio. If you are satisfied with the audio quality, continue with step 11.
- If the selected FM channel doesn't work well

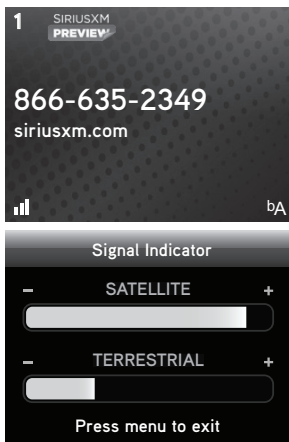

*The screens shown above are representative and may differ from the screens displayed on your Radio.

Vehicle Installation

for you, work down the list of FM channels until you find one with which you are satisfied. Each time, you will need to tune your vehicle's FM radio

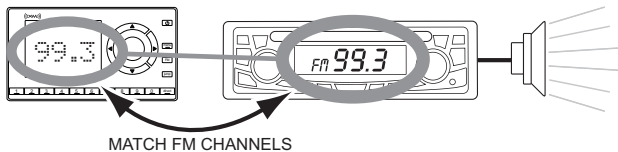

to the FM channel and then set your satellite Radio to transmit on the same FM channel (steps 5 & 8).



TIP: You may find an FM channel with static or silence on your vehicle's FM radio that does not work with your satellite Radio. It is possible that some type of inaudible interference is present that prevents reception of the SiriusXM broadcast. Your only options are to use another FM channel or a different audio connection method.

11. If you are using the wire guide channel across the back of the Vehicle Dock to organize the wires, place the wires in the guide and then tighten the 4 screws to securely attach the mount. The installation is complete.

If the signal reception is good, showing at least two bars of signal strength, but there is no audio, verify that both your satellite Radio and your vehicle's FM radio are tuned to the same FM channel (steps 5 & 8). Also ensure the chosen FM channel is a suitable one to use in your area (step 4). Verify that nothing is plugged into the **green AUDIO** connector on the *PowerConnect* Vehicle Dock. Refer to "Troubleshooting" on page 46 for additional help.

Vehicle Installation

Option 4: FM Direct Adapter (FMDA) Installation

The FMDA needs to be installed by a professional installer. Professional installation can help improve your Radio's reception and significantly reduce the visibility of wires. To learn more, check with the retailer where you bought your Radio.

Troubleshooting

The Vehicle Kit has been designed and built to be trouble-free, but if you experience a problem, try this:

- Check that all connections are firm and secure.
- Make sure the vehicle power socket is clean and free of corrosion.
- Make sure you have connected the Vehicle Dock as described in this User Guide. Verify that the *PowerConnect* Power Adapter is plugged into the vehicle's cigarette lighter or power adapter socket, and that the LED on the *PowerConnect* Power Adapter is lit (on). If not, your vehicle may need to be running to provide power to the socket.

| If you see this on the screen: | Try this: |
|--|--|
| No Signal or No Satellite Signal | <ul style="list-style-type: none">• Make sure that the vehicle is outdoors with a clear view of the sky.• Make sure the Magnetic Mount Antenna is mounted outside of the vehicle.• Move the antenna away from any obstructed area. For example, if you are parked in an underground garage, you should receive a signal after leaving the garage. |
| Check Antenna Connection or Check Antenna or Antenna | <ul style="list-style-type: none">• Make sure that the antenna cable is firmly and securely plugged into the <i>PowerConnect</i> Vehicle Dock. Make sure the cable is not bent or broken.• Turn the Radio Off, then On, to reset this message.• If the message persists, most likely the Magnetic Mount Antenna cable has been damaged. Replace the antenna. |

Troubleshooting

| If you see this on the screen: | Try this: |
|---|---|
| Channel Off Air | <ul style="list-style-type: none">• The channel you've selected is not currently broadcasting. Tune to another channel. |
| Loading or Acquiring Signal | <ul style="list-style-type: none">• Your Radio is acquiring audio or program information. This message usually goes away in a few seconds. |
| Updating | <ul style="list-style-type: none">• Your Radio is updating with the latest encryption code. Wait until the update is done.• You may be trying to tune to a channel that is blocked or unavailable. Tune to another channel. |
| – | <ul style="list-style-type: none">• No program information, such as artist name, song title, or channel exists. |
| If this happens: | Try this: |
| You do not receive all the channels to which you subscribed | <ul style="list-style-type: none">• Ensure that you have subscribed to the service by following the steps in your Radio's User Guide (go to siriusxm.ca/userguides).• Go to siriusxm.ca/refresh and follow the directions refresh your Radio.• Call 1-888-539-7474 for further assistance. |
| Audio sounds too soft | <ul style="list-style-type: none">• Raise the volume of your stereo system or increase the audio level of your Radio until the sound quality improves. Refer to your Radio's User Guide (go to siriusxm.ca/userguides) for instructions. |

Troubleshooting

| If this happens: | Try this: |
|--|---|
| No audio when using the Aux In Cable or Cassette Adapter | <ul style="list-style-type: none">• Check all cables between your Radio and your vehicle's stereo system for a firm and secure connection.• Ensure you have selected the proper input source on your vehicle's stereo system.• Increase the audio level of your Radio. Refer to your Radio's User Guide (go to siriusxm.ca/userguides) for instructions.• Ensure that the FM Transmitter in the Radio is turned Off. Refer to your Radio's User Guide (go to siriusxm.ca/userguides) for instructions. |
| Audio fades or has static when listening | <ul style="list-style-type: none">• Check all cables for a firm and secure connection.• If you are using <i>PowerConnect</i> to listen via your vehicle's FM radio, and the problem persists, it most likely is interference from another commercial or broadcast FM station. You will need to find an unused or available FM channel in your area. Refer to step 4 on page 42.• If you are using <i>PowerConnect</i>, and you cannot solve the audio problem, try connecting the audio using the Aux In Cable or a Cassette Adapter. (Refer to page 38 and page 40.) If you cannot use those solutions, consider using an FM Direct Adapter. (Refer to page 44.) |

Troubleshooting

| If this happens: | Try this: |
|--|---|
| No audio when using <i>PowerConnect</i> or <i>FMDA</i> | <ul style="list-style-type: none">• Check that your Radio and your vehicle's FM radio are tuned to the same FM channel.• Check that the FM transmitter in your Radio is On. Refer to your Radio's User Guide (go to siriusxm.ca/userguides) for instructions. |
| No song title or artist name is displayed | <ul style="list-style-type: none">• The information may not be available or updates may be in progress. |
| Traffic and Weather channels sound different from other channels | <ul style="list-style-type: none">• These channels use a different audio technology than other channels so they often sound different from other channels. |
| The Radio shuts off unexpectedly | <ul style="list-style-type: none">• If your Radio has these features, check these: If <i>Delayed Power</i> or <i>Automatic Power</i> is On, the Radio will turn off after the selected length of time in the dock. Set <i>Delayed Power</i> or <i>Automatic Power</i> to Off. Refer to your Radio's User Guide (go to siriusxm.ca/userguides) for instructions. |
| The demo is playing | <ul style="list-style-type: none">• Your Magnetic Mount Antenna is not connected or you are not receiving the signal. Check that the antenna is connected properly and is not obstructed.• Refer to your Radio's User Guide (go to siriusxm.ca/userguides) and disable Demo Mode. |

Product Specifications

System

| | |
|------------------------|---------------------------------|
| Power Requirements: | 9-16 V DC, 500 mA (max) |
| Operating Temperature: | -4°F to +140°F (-20°C to +60°C) |
| Audio Output: | 1.0 Vrms (max) |

PowerConnect Vehicle Dock

| | |
|---------------------------|--|
| Dimensions: | 4.1 in (width) x 1.8 in (height) x 1.1 in (depth) 105 mm (width) x 46 mm (height) x 28 mm (depth) |
| Weight (without adapter): | 1.4 oz (40 g) |
| Weight (with adapter): | 1.5 oz (43 g) |
| Audio Connector: | 1/8 in (3.5 mm) female |
| Antenna Connector: | SMB male |

PowerConnect Power Adapter

| | |
|-----------------|---|
| Dimensions: | 3.7 in (width) x 1.7 in (height) x 1.3 in (depth) 94 mm (width) x 43 mm (height) x 34 mm (depth) |
| Weight: | 2.4 oz (69 g) |
| Input / Output: | 9-16 V DC / 5 V DC, 1.5 A |
| Cable Length: | Approximately 4.6 ft (1.4 m) |

Vehicle Antenna

| | |
|---------------|-----------------------------|
| Type: | SiriusXM Magnetic Mount |
| Connector: | SMB female, right angle |
| Cable Length: | Approximately 23 ft (7.0 m) |

Aux In Cable

| | |
|---------------|---|
| Connectors: | 1/8 in (3.5 mm) stereo male to 1/8 in (3.5 mm) stereo male |
| Cable Length: | Approximately 4 ft (1.2 m) |

Patent and Environmental Information

Patent Information

It is prohibited to, and you agree that you will not, copy, decompile, disassemble, reverse engineer, hack, manipulate, or otherwise access and/or make available any technology incorporated in this product. Furthermore, the AMBE™ voice compression software included in this product is protected by intellectual property rights including patent rights, copyrights, and trade secrets of Digital Voice Systems, Inc. The software is licensed solely for use within this product. The music, talk, news, entertainment, data, and other content on the Services are protected by copyright and other intellectual property laws and all ownership rights remain with the respective content and data service providers. You are prohibited from any export of the content and/or data (or derivative thereof) except in compliance with applicable export laws, rules and regulations. The user of this or any other software contained in a SiriusXM Radio is explicitly prohibited from attempting to copy, decompile, reverse engineer, hack, manipulate or disassemble the object code, or in any other way convert the object code into human-readable form.

Environmental Information

Follow local guidelines for waste disposal when discarding packaging and electronic appliances.

IC Statement

Operation is subject to the following two conditions: (1) this device may not cause interference, and (2) this device must accept any interference, including interference that may cause undesired operation of the device. For product available in the Canada market, only channel 1~11 can be operated. Selection of other channels is not possible. This device and its antenna(s) must not be co-located or operation in conjunction with any other antenna or transmitter. To reduce potential radio interference to other users, the antenna type and its gain should be so chosen that the equivalent isotropically radiated power (e.i.r.p) is not more than that permitted for successful communication. IC Radiation Exposure Statement: This equipment complies with IC RSS-102 radiation exposure limits set forth for an uncontrolled environment. This equipment should be installed and operated with minimum distance 20cm between the radiator & your body.

WARNING! The FCC and FAA have not certified this Satellite Radio Receiver for use in any aircraft (neither portable nor permanent installation). Therefore, SiriusXM cannot support this type of application or installation.

Copyrights and Trademarks

© 2016 Sirius XM Canada Inc. "SiriusXM", the SiriusXM logo, channel names and logos are trademarks of Sirius XM Radio Inc. and are used under license. "NFL" and the NFL Shield design are trademarks of the National Football League. NASCAR® is a registered trademark of the National Association for Stock Car Auto Racing, Inc. The NBA and NBA member team identifications are the intellectual property of NBA Properties, Inc. and the respective NBA member teams. © 2016 NBA Properties, Inc. All rights reserved. NHL and the NHL Shield are registered trademarks of the National Hockey League. © NHL 2016. Elvis Radio logo © EPE Reg. U.S. Pat & TM off. CFL® is a registered trademark of the Canadian Football League. All other trademarks, service marks, images and logos are property of their respective owners and are used with permission. All Rights Reserved. Required subscription sold separately. Pricing and programming is subject to change. Premier subscription required for some channels. See Customer Agreement for complete terms at siriusxm.ca.

siriusxm.ca

**Sirius XM Canada Inc.
135 Liberty St. - 4th floor
Toronto, Ontario, M6K 1A7**

1-888-539-7474

© 2016 Sirius XM Canada Inc.

SXDV3UG E 160210a