



User Guide

Vehicle Kit For XM Radios

Table of Contents

Introduction	5
Features.....	6
Safety and Care Information	7
What's in the Box?.....	9
Vehicle Dock	10
Vehicle Installation	13
Step 1: Choose a Location for Your Radio.....	14
Step 2: Install the Dash or Window Mount	16
Step 3: Mount the Magnetic Mount Antenna	20
Step 4: Route the Magnetic Mount Antenna Cable.....	26
Step 5: Connect the Magnetic Mount Antenna and <i>PowerConnect</i> Power Adapter ..	37
Step 6: Connect the Audio	38
Troubleshooting	47
Product Specifications	53
Patent Information.....	55
Environmental Information.....	55

Introduction

Features

Thank you for purchasing the vehicle kit for XM radios!

The Vehicle Kit lets you easily move your SiriusXM Radio to a second vehicle so you can enjoy your favourite programming in whichever vehicle you choose to drive.

Compatible with the Edge, OnyX, XpressRCi, XpressRC, XpressR, and XpressEZ Radios

For the latest information about this and other SiriusXM products and accessories, visit www.siriusxm.ca or your local retailer.

*FM radio required. If your vehicle has an Aux Input, use the included Aux In Cable for best performance. It will also work with Cassette Adapter (sold separately).

Safety and Care Information



IMPORTANT! Self installation instructions and tips are provided for your convenience. It is your responsibility to determine if you have the knowledge, skills, and physical ability required to properly perform an installation. SiriusXM shall have no liability for damage or injury resulting from the installation or use of any SiriusXM or third party products. It is your responsibility to ensure that all products are installed in adherence with local laws and regulations and in such a manner as to allow a vehicle to be operated safely and without distraction. SiriusXM product warranties do not cover the installation, removal or reinstallation of any product.

- Do not expose to extreme temperatures (above 140°F or below -4°F, or above 60°C or below -20°C).
- Do not expose to moisture. Do not use device near or in water. Do not touch the device with wet hands.
- Do not let any foreign matter spill into device.
- Do not store in dusty areas.
- Do not expose to chemicals such as benzene and thinners. Do not use liquid or aerosol cleaners. Clean with a soft damp cloth only.
- Do not expose to direct sunlight for a prolonged period of time, and do not expose to fire, flame, or other heat sources.
- Do not try to disassemble and/or repair device yourself.
- Do not drop your device or subject it to severe impact.
- Do not place heavy objects on device.
- Do not subject device to excessive pressure.

Introduction

WARNING!

- Opening the case may result in electric shock.
- Make sure that you insert the *PowerConnect*™ Power Adapter's plug all the way into the vehicle's cigarette lighter or power adapter socket.
- If you are using *PowerConnect* as your audio connection option, it is advisable not to insert a multi-outlet adapter into the same vehicle cigarette lighter or power adapter socket to simultaneously power other devices. Some multi-outlet adapters can prevent the *PowerConnect* feature from working properly.
- When using this product, it is always important to keep your eyes on the road and hands on the wheel. Not doing so could result in personal injury, death, and/or damage to your device, accessories, and/or to your vehicle or other property.
- Vehicle installation, service activation, and Radio configuration functions should not be performed while driving. Park your vehicle in a safe location before beginning installation.

Your device should be placed in your vehicle where it will not interfere with the function of safety features, e.g., deployment of airbags. Failure to correctly place device may result in injury to you or others, if the unit becomes detached during an accident and/or obstructs the deployment of an airbag.

What's in the Box?

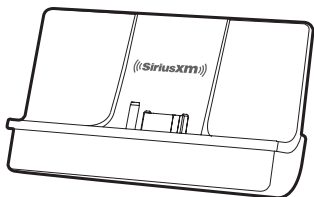

Vehicle Dock



Aux In Cable

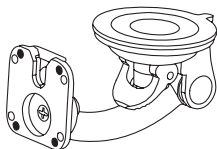

Window Mount

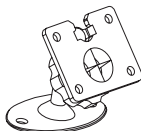

Dash Mount



Screws (4)

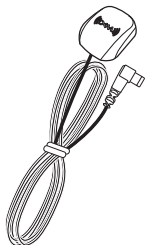

Magnetic Mount
Antenna

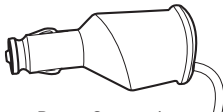

PowerConnect
Power Adapter



Cable
Routing Adapter



Alcohol
Preparation Pads

Introduction

Vehicle Dock

Color-Coded Connections

The color-coded Vehicle Dock makes it simple to connect. Just match the colors on the cable ends to the colors on the dock to see what goes where.

Rear View

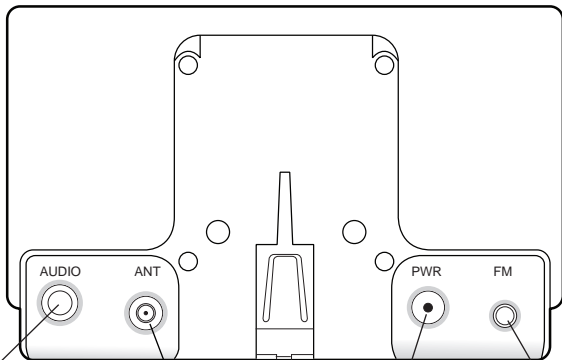

AUDIO (Green)
Connection for Aux In
Cable or optional
Cassette Adapter
(sold separately).

ANT (Silver)
Connection for
the Magnetic
Mount Antenna.

PWR (Red)
Connection for
PowerConnect
Power Adapter.

FM (Blue)
Connection for
optional FM Direct
Adapter (sold
separately).

Wire Guide

The Vehicle Dock has a wire guide at the top rear to help organize the cables and wires connected to the dock. If you need to bring a cable or wire from one side of the dock to the other, utilize the wire guide by looping the cable through the wire guide as shown.

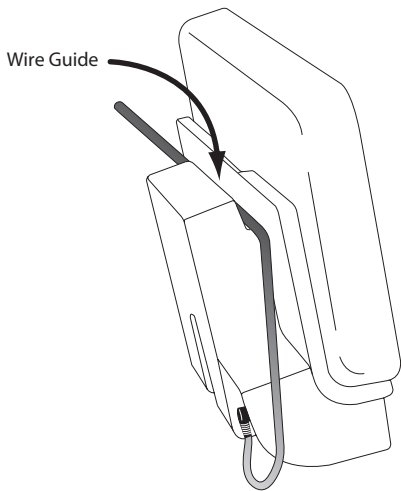

Vehicle Installation

Vehicle Installation



WARNING! DO NOT attempt to install the Vehicle Kit while driving. Park your vehicle in a safe location before beginning installation.

Step 1: Choose a Location for Your Radio

When installing the Vehicle Dock in your vehicle, choose a location where it will not block your vision, interfere with the controls, or obstruct the air bag. The location should be easily accessible and provide good visibility of the display, and should not be located where it may be in direct sunlight, which will affect the visibility of the display screen.

Several examples of the Vehicle Dock and Radio mounted in a vehicle are shown: **A** is the on dash method using the Dash Mount, and **B** is the on windshield method using the Window Mount.

Option 1

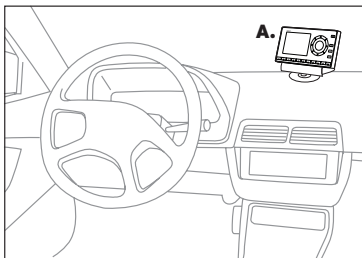

Option 2

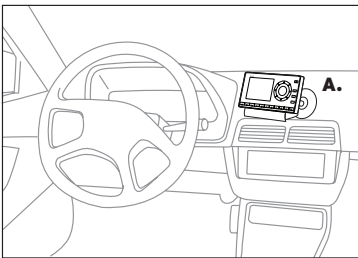

Option 3

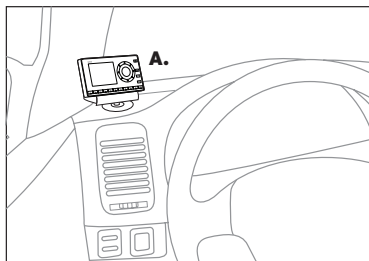

Option 4

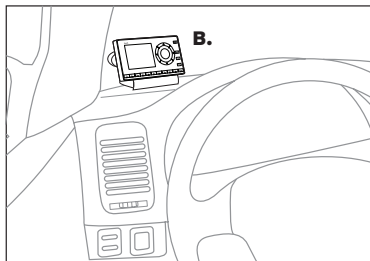

Option 5

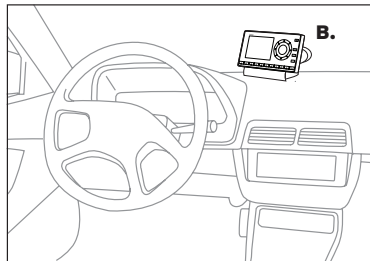

Vehicle Installation

Step 2: Install the Dash or Window Mount

Follow the instructions on the next several pages for the mounting method you have selected.



NOTE! The PowerConnect Vehicle Dock is compatible with the T-slot style Dash and Vent Mounts. If you have an existing Dash Mount or Vent Mount in your vehicle, and you want to continue to use it with this dock, skip this step.

Installing the Dash Mount:



CAUTION! The adhesive used on the Dash Mount may be difficult to remove. Do not install this mount on leather surfaces (contact your automobile dealership if you are unsure about your dash surface), and make sure the air temperature is at least 60°F (15°C) during installation. If it's not at least 60°F, turn on the heater in your vehicle to bring the temperature up to 60°F.

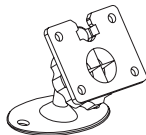

- 1 Locate a flat surface for the Dash Mount. Make sure there is ample room for the PowerConnect Vehicle Dock and your Radio when installed.
- 2 Set the orientation of the Dash Mount before adhering it. Loosen the knob and adjust the adhesive foot for the location you selected in "Step 1: Choose a Location for Your Radio" on page 14.

- Option 1 & Option 3 should be oriented as **1**.
- Option 2 should be oriented as **2**.

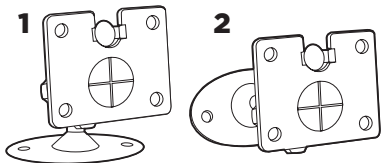

- 3 The dock mounting plate can be tilted in different directions. Adjust as necessary for your particular

vehicle. When the orientation is correct, tighten the knob.

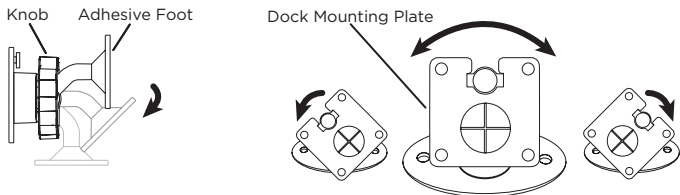

- 4 Attach the Dash Mount to the *PowerConnect Vehicle Dock* using the 4 provided screws.
- 5 Before you attach the Dash Mount to the dash, skip ahead and finish the remainder of the vehicle installation so that the cables are attached to the dock.
- 6 Once the cables have been attached to the dock, clean the mounting surface in the vehicle with the alcohol preparation pad and let it dry thoroughly.
- 7 Peel off the adhesive liner. Position, press, and hold the Dash Mount in place for 30 seconds.

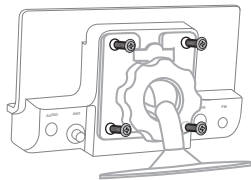

IMPORTANT! Allow the Dash Mount adhesive to cure (dry) for a minimum of 2-4 hours before using the mount. The best adhesion occurs after 24 hours.



TIP! To remove the Dash Mount, carefully lift the adhesive pad with your fingers or a spoon. Warming the pad with a hair dryer for several minutes will help soften the adhesive.

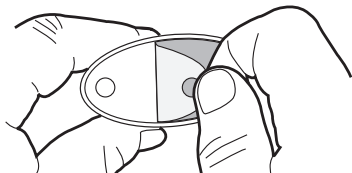

Vehicle Installation

Installing the Window Mount:



IMPORTANT! States or localities may prohibit driving with a window mount on the windshield. When driving in these areas, the dash or vent mounting option should be used instead. Check your state or local laws for any applicable restrictions. Sirius XM Radio Inc. does not take any responsibility for any fines, penalties or damages that may be incurred as a result of disregarding this notice.

- 1 Attach the Window Mount to the *PowerConnect* Vehicle Dock using the 4 provided screws.
- 2 Before you attach the Window Mount to the windshield, skip ahead and finish the remainder of the vehicle installation so that the cables are attached to the dock.

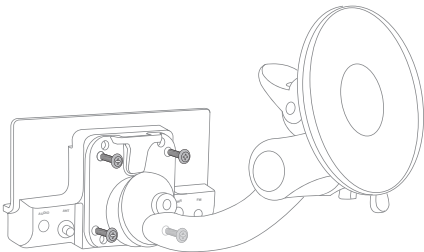

- 3 Once the cables have been attached to the dock, locate a place on the windshield for the mount. Make sure there is ample room for the Radio when installed, and that it does not block the driver's vision or any airbag. (Airbag locations are typically marked with "SRS" logos.)
- 4 Clean the window surface with the alcohol preparation pad and let it dry thoroughly.



Note! For greater clarity, the next illustrations do not show the dock attached to the Window Mount, however, the dock should be attached before continuing.

- 5** Press and hold the mount against the windshield. Then press the lever all the way down to attach the Window Mount to the windshield.

- 6** Loosen the knob on the Window Mount to adjust the height of the Radio for the best view. Once the height is correct, tighten the knob. The dock mounting plate can be swiveled to the left or right, and adjusted up or down, to optimize the driver's view of the Radio.

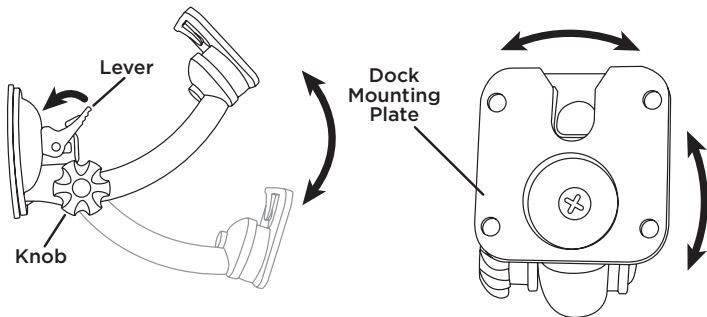
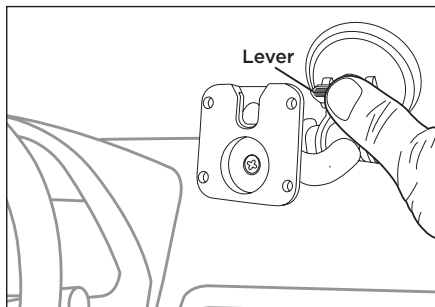

Vehicle Installation

Step 3: Mount the Magnetic Mount Antenna

Mount the Magnetic Mount Antenna on the outside of your vehicle, on a horizontal surface that will always face the sky. The antenna contains a strong magnet which will stick to any metal part of your vehicle, but will not damage the vehicle.

To install the Magnetic Mount Antenna:

- 1 Choose the best location for the antenna considering your vehicle type. Pay particular attention to any accessories that you may have like luggage racks and how frequently you may use them.

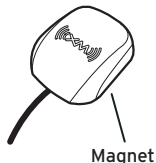

Sedan/Coupe: We recommend mounting the antenna just above either the front windshield or the back window as shown.

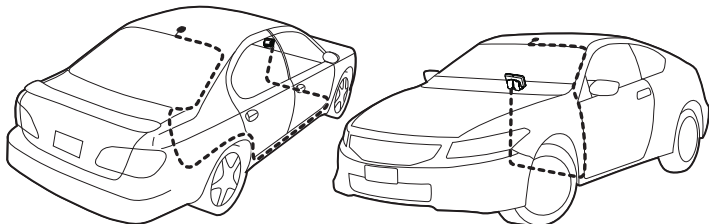

SUV: We recommend mounting the antenna at the rear of the roof as shown.

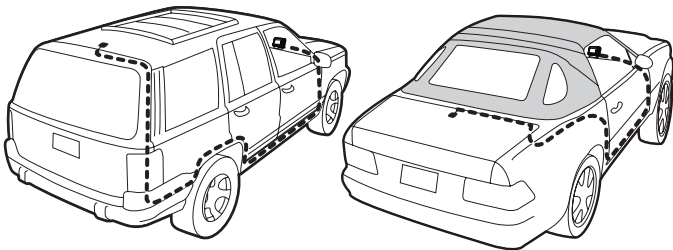

Convertible: We recommend mounting the antenna at the leading edge of the trunk as shown.

Pickup Truck: We recommend mounting the antenna just above the front windshield as shown.



IMPORTANT! Consult a professional installer if your vehicle roof or hood is non-metallic (i.e., fiberglass), or you have difficulty finding a location for your antenna.

- 2 Clean the surface of the selected mounting location using the alcohol preparation pad and let it dry thoroughly.

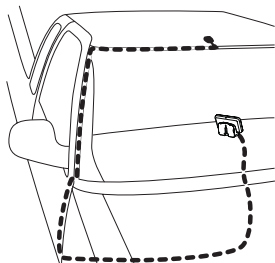

Vehicle Installation

- 3** If you are installing the antenna at the roof edge, or hood edge, install the Cable Routing Adapter to direct the antenna cable downward.

Without Cable
Routing Adapter
Installed

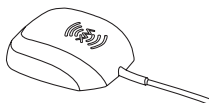

With Cable
Routing Adapter
Installed



Cable Routing
Adapter orientation

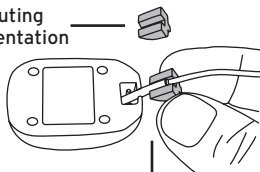

Place the antenna wire
into the groove of the
Cable Routing Adapter

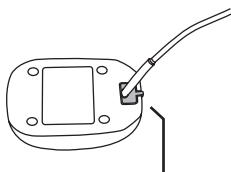

Slide the Cable Routing
Adapter down the antenna
wire and press it into the
antenna
until it is flush with the bottom
of the antenna

- 4 Place the antenna in the location you selected. Follow the Tips and Cautions shown on the next several pages.

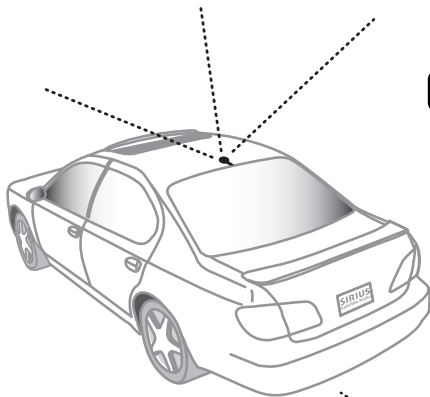

TIP! Mount the antenna on the roof (for most vehicles) or trunk (for convertibles) where it has a clear view of the sky in all directions.

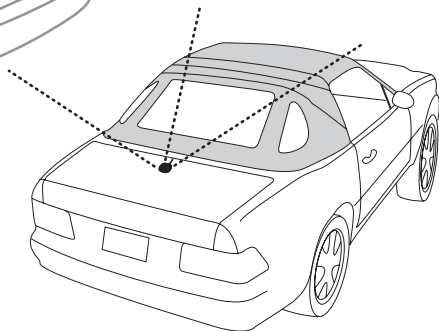

Vehicle Installation



CAUTION! Don't mount the antenna inside the vehicle, for example, on the dashboard.

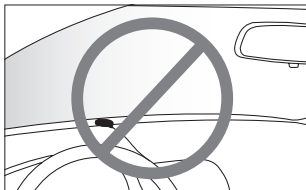

CAUTION! Don't mount the antenna on any of the vehicle's front, back or side pillars.

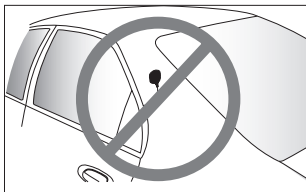

CAUTION! Don't mount the antenna close to a roof rack. Adjust the rack so it's further away from the antenna or move the antenna closer to the center of the roof.

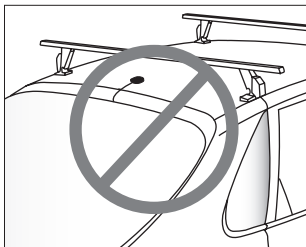



CAUTION! Don't mount the antenna close to another antenna. Mount it at least 3 inches away.

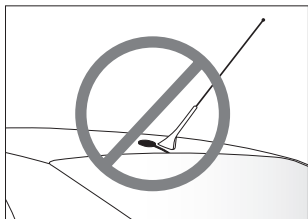

Vehicle Installation

Step 4: Route the Magnetic Mount Antenna Cable

Before you begin routing the antenna cable, read these general instructions for how to route and hide the antenna cable. Then route your antenna cable according to the instructions which follow for your specific type of vehicle.

Use a blunt plastic putty knife, a credit card, a plastic knife, or a similar blunt tool to lift the rubber window moulding

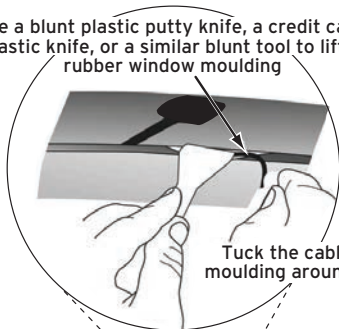

Tuck the cable under the moulding around the window

Feed cable under rubber moulding around window

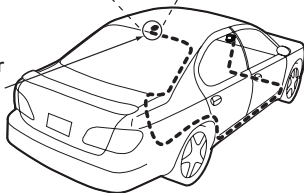

Route cable out from under rear windshield moulding and tuck into weatherstripping around trunk opening
Avoid sharp bends by running cable through weatherstripping for several inches



Pull weatherstripping from trunk opening



Tuck cable into weatherstripping.
Route cable through weatherstripping several inches to avoid sharp bends

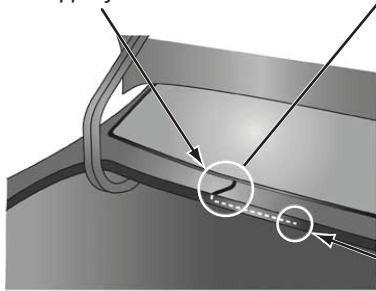

Pull cable out of weatherstripping and route through trunk to cabin

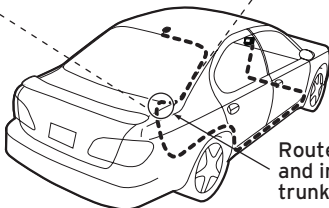

Route cable out of window moulding and into weatherstripping around trunk opening

Vehicle Installation

Bring cable out of weatherstripping and into trunk

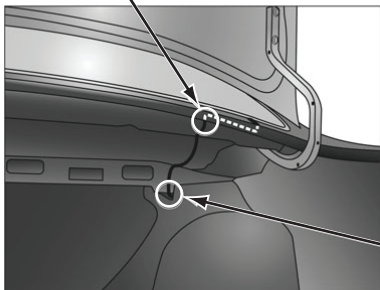

Route cable along trunk wall and into cabin through gap or conduit, along existing wiring harness

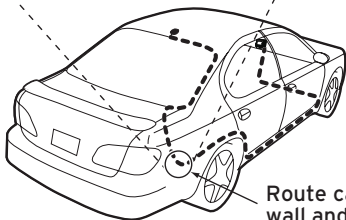

Route cable along trunk wall and into cabin

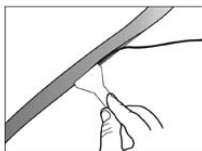

Use a blunt plastic putty knife or similar blunt tool to lift edge of interior trim and tuck cable under trim. Continue towards front of vehicle

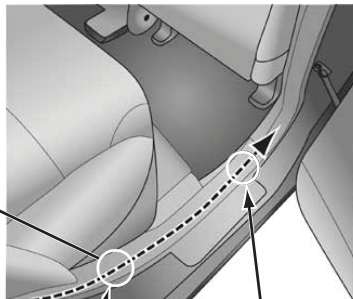

Route cable under trim or upholstery

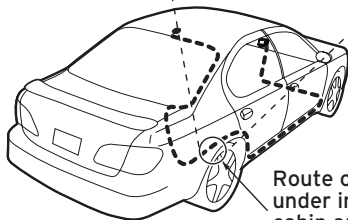

Route cable from trunk under interior trim, into cabin and towards front of vehicle

Continue routing cable under trim or carpet towards front of vehicle

Vehicle Installation

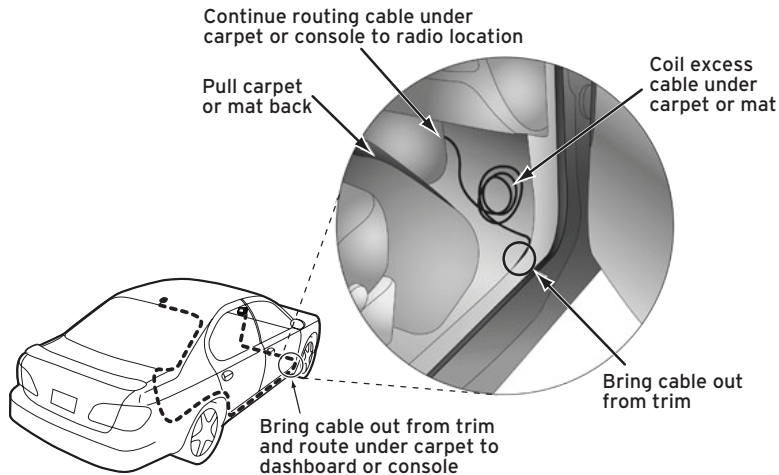

TIP! Always be careful to include enough slack in your cable to accommodate open doors or trunk lids. Use things typically found around the home, like electrical tape, to secure cables in areas so that hinges do not pinch the cable with the door. Hide any excess cable in the trim.

• **Sedan/Coupe With the Antenna Placed at the Rear of the Roof:**

1. Feed the antenna cable from the antenna underneath the rubber molding around the rear window. Use a blunt plastic putty knife or similar blunt tool to lift the rubber molding around the rear window and tuck the antenna cable underneath the molding. Route the antenna cable around and down the window to the lowest point. If your rear window does not have rubber molding, we recommend consulting a professional installer.
2. Route the antenna cable out of the window molding and into the rubber weather stripping around the trunk opening. Lift the weather stripping from the opening and tuck the cable inside it, then replace the weather stripping. To avoid sharp bends in the cable, run the cable inside the weather stripping for a few inches, then remove the cable from the weather stripping inside the trunk. Keep the cable away from hinges, gears, etc., that could damage it.
3. Route the cable out from the rubber weather stripping and along the trunk wall. Continue routing the cable into the vehicle cabin through a conduit or along an existing wiring harness.
4. Route the cable through the main cabin area under the interior trim, towards the front of the vehicle. Use a blunt plastic putty knife or similar blunt tool to lift the plastic trim just enough to tuck the cable under underneath. Avoid side airbag locations on back pillars and above the doors. Airbag locations are marked

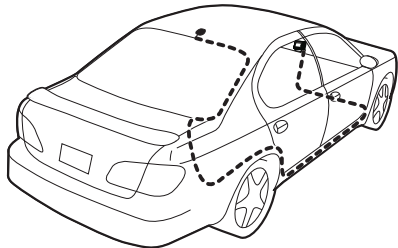

Vehicle Installation

- with "SRS" logos. Be careful not to crimp or cut the cable.
5. Bring the cable out from the trim near the front of the cabin and route it under the carpet toward the dashboard or console. Coil any excess cable in a hidden location, such as under the carpet, keeping it away from any vehicle pedals or controls. Secure the excess cable with wire ties (purchased separately).
 6. Bring the end of the cable out at the Vehicle Dock location. Leave yourself enough cable so you can easily connect it to the antenna connector of the dock.
 7. Continue with "Step 5: Connect the Magnetic Mount Antenna and PowerConnect Power Adapter" on page 37.

• **Sedan/Coupe With the Antenna Placed at the Front of the Roof:**

1. Feed the antenna cable from the antenna underneath the rubber molding around the windshield. Use a blunt plastic putty knife or similar blunt tool to lift the rubber molding around the windshield and tuck the antenna cable underneath the molding. Route the antenna cable around and down the windshield to the lowest point.
2. At the lowest corner of the windshield, route the cable out of the windshield molding and into the rubber weather stripping around the door opening. Lift the weather stripping from the opening and tuck the cable inside it, then replace the weather stripping. Run the cable inside of the weather stripping to the bottom of the door opening.
3. Pull the cable out of the weather stripping at the bottom of the door opening and route it under the carpet toward the dashboard. Coil any excess cable in a hidden location, such as under the carpet, keeping it away from any vehicle pedals or controls. Secure the excess cable with wire ties.
4. Bring the end of the cable out at the Vehicle Dock location. Leave yourself enough cable so you can easily connect it to the antenna connector of the dock.
5. Continue with “Step 5: Connect the Magnetic Mount Antenna and PowerConnect Power Adapter” on page 37.

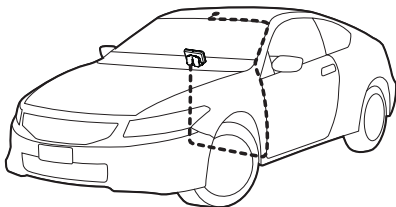

Vehicle Installation

• SUV:

1. Feed the antenna cable underneath the rubber weather stripping of the rear tailgate window/door and route the cable along the rear hatch. Lift the weather stripping from the opening and tuck the cable inside it, then replace the weather stripping. Pull the cable out from weather stripping and route it into the cabin under the interior trim. Avoid hinges or gears that could crimp or cut the cable.
2. Route the cable through the SUV's main cabin area under the interior trim, towards the front of the vehicle. Use a blunt plastic putty knife or similar blunt tool to lift the plastic trim just enough to tuck the cable under underneath. Avoid side airbag locations on back pillars and above the doors. Airbag locations are marked with "SRS" logos. Be careful not to crimp or cut the cable.
3. Bring the cable out from the trim near the front of the cabin and route it under the carpet toward the dashboard or console. Coil any excess cable in a hidden location, such as under the carpet, keeping it away from any vehicle pedals or controls. Secure the excess cable with wire ties (purchased separately).
4. Bring the end of the cable out at the Vehicle Dock location. Leave yourself enough cable so you can easily connect it to the antenna connector of the dock.
5. Continue with "Step 5: Connect the Magnetic Mount Antenna and PowerConnect Power Adapter" on page 37.

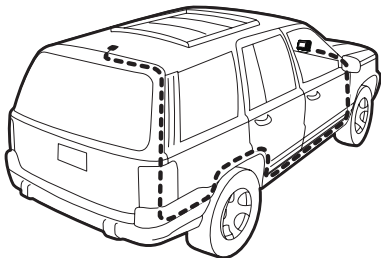

6. Convertible:

1. Bring the antenna cable from the antenna into the trunk at the front edge of the trunk lid. Keep any bends in the cable loose. Tape or tie the cable along the inside of the trunk lid to the trunk lid hinge strut.
2. Allow enough slack in the cable so the trunk lid can easily open and close and keep the cable away from hinges, gears, etc., that could crimp or cut it. Route the cable along the trunk wall and into the cabin through a conduit or along an existing wiring harness.
3. Route the cable through the main cabin area under the interior trim, towards the front of the vehicle. Use a blunt plastic putty knife or similar blunt tool to lift the plastic trim just enough to tuck the cable under underneath. Avoid side airbag locations on back pillars and above the doors. Airbag locations are marked with "SRS" logos. Be careful not to crimp or cut the cable.
4. Bring the cable out from the trim near the front of the cabin and route it under the carpet toward the dashboard or console. Coil any excess cable in a hidden location, such as under the carpet, keeping it away from any vehicle pedals or controls. Secure the excess cable with wire ties (purchased separately).
5. Bring the end of the cable out at the Vehicle Dock location. Leave yourself enough cable so you can easily connect it to the antenna connector of the dock.
6. Continue with "Step 5: Connect the Magnetic Mount Antenna and PowerConnect Power Adapter" on page 37.

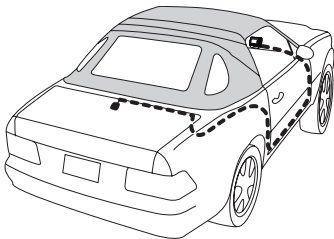

Vehicle Installation

• Pickup Truck:

1. Use a blunt plastic putty knife or similar blunt tool to lift the rubber molding around the windshield and tuck the antenna cable underneath it.
2. Continue tucking the cable underneath the windshield molding around the windshield to the lowest corner.
3. At the lowest corner of the windshield, route the cable out of the windshield molding and into the rubber weather stripping around the door opening. Lift the weather stripping from the opening and tuck the cable inside it, then replace the weather stripping. Run the cable inside of the weather stripping to the bottom of the door opening.
4. Pull the cable out of the weather stripping at the bottom of the door opening and route it under the carpet toward the dashboard. Coil any excess cable in a hidden location, such as under the carpet, keeping it away from any vehicle pedals or controls. Secure the excess cable with wire ties.
5. Bring the end of the cable out at the Vehicle Dock location. Leave yourself enough cable so you can easily connect it to the antenna connector of the dock.
6. Continue with "Step 5: Connect the Magnetic Mount Antenna and PowerConnect Power Adapter" on page 37.

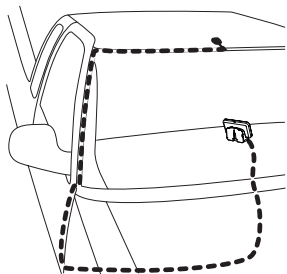

Step 5: Connect the Magnetic Mount Antenna and PowerConnect Power Adapter

- 1 Plug the Magnetic Mount Antenna into the **silver ANT** connector on the Vehicle Dock.

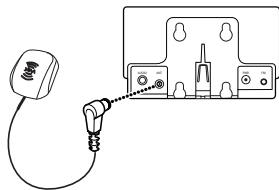

- 2 Insert the PowerConnect Power Adapter into your vehicle's cigarette lighter or power adapter socket.

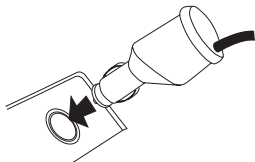

- 3 Plug the PowerConnect Power Adapter into the **red PWR** connector on the dock.

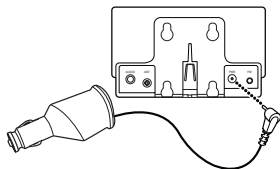

Vehicle Installation

Step 6: Connect the Audio

To play audio through your vehicle's stereo or FM radio, decide on one of the following audio connection options:

- **Option 1: Best:** Use the provided **Aux In Cable** if your vehicle's stereo system has an auxiliary input connection or jack. Refer to your vehicle's owners manual to find the location of the auxiliary input jack, or consult the vehicle dealer.



TIP! The auxiliary input jack may be located on the face plate of the vehicle radio, on the back of the radio, anywhere on the front dash panel, inside the glove compartment, or inside the center console in between the front seats.

- **Option 2: Better:** Use a **Cassette Adapter** if your vehicle has a built-in cassette player. Cassette Adapters are sold separately and can be purchased from an electronics retailer, or go to www.xmradio.com/accessories.
- **Option 3: Good:** Use the **PowerConnect** Power Adapter to play the audio through your vehicle's FM radio.
- **Option 4: Best:** Use the **FM Direct Adapter**. If none of the previous three audio connection options will work in your vehicle, then you will need to use the FM Direct Adapter (FMDA) (sold separately). The FMDA needs to be installed by a professional installer and directly connects the Radio to your vehicle's FM radio. To learn more, check with the retailer where you bought your Radio, or visit www.siriusxm.ca.

Follow the installation instructions in the next several sections for the audio connection option that you have selected.

Option 1: Aux In Cable Installation Instructions

- 1 Plug one end of the Aux In Cable into the **green AUDIO** connector on the dock.



- 2 Plug the other end into the auxiliary input jack connection of your vehicle's stereo system.
- 3 Insert your Radio into the dock.
- 4 Be sure the vehicle is outside and the antenna has a clear view of the sky.
- 5 Power on your Radio by pressing the **Power button**.
- 6 If your Radio is not yet activated, ensure that your Radio is tuned to channel 1.
- 7 Turn on your vehicle's stereo system. Set it to play input from the auxiliary input source. You should hear the SiriusXM audio through your vehicle's stereo system.
- 8 Go back to "Step 2: Install the Dash or Window Mount" on page 16 and finish installing the Dash or Window Mount. Then the installation is complete.

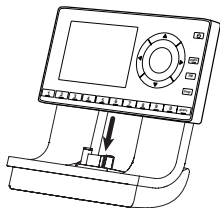

Vehicle Installation

- 9 The audio level output of the Radio can be increased or decreased as necessary to match the audio levels of other sources in your vehicle. Refer to the User Guide which accompanied your Radio for instructions.

If the signal reception is good, showing at least one bar of antenna signal strength, but there is no SiriusXM audio, be sure the vehicle's stereo system is set to the auxiliary input source (step 7). Also be sure that the audio level is set high enough to be heard (step 9). Refer to "Troubleshooting" on page 48 for additional help.

Option 2: Cassette Adapter Installation Instructions

- 1 Plug the Cassette Adapter into the **green AUDIO** connector on the dock.
- 2 Insert the Cassette Adapter into the vehicle's cassette deck. You may need to turn on your vehicle's stereo system in order to do so.
- 3 Insert your Radio into the dock.
- 4 Be sure the vehicle is outside and the antenna has a clear view of the sky.
- 5 Power on your Radio by pressing the **Power button**.
- 6 If your Radio is not yet activated, ensure that your Radio is tuned to channel 1.
- 7 If you haven't done so, turn on your vehicle's stereo system. Set it to play input from the cassette source. You should hear the SiriusXM audio through your vehicle's stereo system.
- 8 Go back to "Step 2: Install the Dash or Window Mount" on page 16 and finish installing the Dash or Window Mount. Then the installation is complete.
- 9 The audio level output of the Radio can be increased or decreased as necessary to match the audio levels of other sources in your

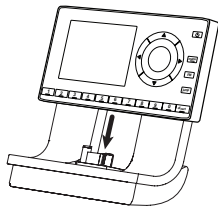
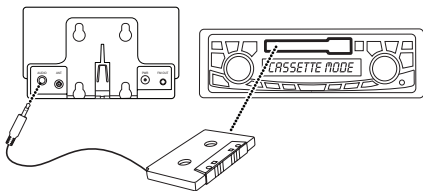

Vehicle Installation

vehicle. Refer to the User Guide which accompanied your Radio for instructions.

If the signal reception is good, showing at least one bar of antenna signal strength, but there is no SiriusXM audio, be sure the vehicle's stereo system is set to the cassette source (step 7). Also be sure that the audio level is set high enough to be heard (step 9). Refer to "Troubleshooting" on page 48 for additional help.

Option 3: *PowerConnect* Installation Instructions

- 1 Insert your Radio into the dock.
- 2 Be sure the vehicle is outside and the antenna has a clear view of the sky.
- 3 You'll first need to find an available FM channel. An available FM channel is one that's not being used by an FM radio station in your area. When you tune your FM radio to an available channel, you should only hear static or silence - not talk or music.

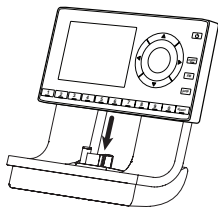

- TIP!** You'll need to use the 'Manual' tune function on your vehicle's FM radio to tune through every FM channel one-by-one. Turn on your vehicle's FM radio. Start at 88.1 and use the 'Manual' tune function on your vehicle's FM radio to tune through each FM channel one-by-one (88.1 followed by 88.3 etc.) to locate channels that aren't being used by a local FM radio station. Write down each FM channel that has only static or silence on it, until you reach 107.9.
- 4 Pick the first FM channel on your list from step 3. Turn on your vehicle's FM radio (if you have not already done so) and tune it to this FM channel.
 - 5 Power on your Radio by pressing the **Power button**.
 - 6 If your Radio is not yet activated, ensure that your Radio is tuned to channel 1.
 - 7 Set your Radio to transmit on the same FM channel that you have selected in step 4. You may need to turn On the FM Transmitter in your Radio first. Refer to the User Guide that accompanied your Radio.
 - 8 You should hear SiriusXM channel 1 through your vehicle's FM radio. If you are satisfied with the sound quality, go back to "Step 2: Install the

Vehicle Installation

Dash or Window Mount” on page 16 and finish installing the Dash or Window Mount. Then the installation is complete.

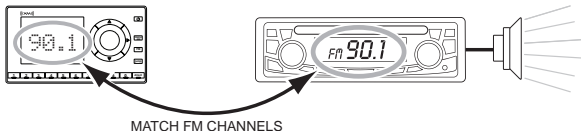

- 9 If the selected FM channel doesn't work well for you, work down the list of FM channels until you find one with which you are satisfied. Each time, you will need to tune your vehicle's FM radio to the FM channel and then set your Radio to transmit on the same FM channel (steps 4 & 7).

If the signal reception is good, showing at least one bar in the lower left corner of the display, but there is no SiriusXM audio, verify that both your Radio and your vehicle's FM radio are tuned to the same FM channel (steps 4 & 7). Also ensure the chosen FM channel is a suitable one to use in your area (step 3). Verify that nothing is plugged into the **AUDIO** connector on the Vehicle Dock. Refer to "Troubleshooting" on page 48 for additional help.

Option 4: FM Direct Adapter (FMDA) Installation

The FMDA needs to be installed by a professional installer. Professional installation can help improve your Radio's reception and significantly reduce the visibility of wires. To learn more, check with the retailer where you bought your Radio, or go to www.siriusxm.ca.

Troubleshooting

Troubleshooting

This Vehicle Kit has been designed and built to be trouble-free, but if you experience a problem, try this:

- Check that all connections are firm and secure.
- Make sure the vehicle power socket is clean and free of corrosion.
- Make sure you have connected the Radio as described in this User Guide. Verify that the *PowerConnect Power Adapter* is plugged into the vehicle's cigarette lighter or power adapter socket, and that the LED on the *PowerConnect Power Adapter* is lit (on). If not, your vehicle may need to be running to provide power to the socket.

If you see this on the screen:	Try this:
Acquiring Signal or No Signal	<ul style="list-style-type: none">• Make sure that the vehicle is outdoors with a clear view of the sky.• Make sure the Magnetic Mount Antenna is mounted outside of the vehicle.• Move the antenna away from any obstructed area. For example, if you are parked in an underground garage, you should receive a signal after leaving the garage.
Check Antenna Connection or Check Antenna or Antenna	<ul style="list-style-type: none">• Make sure that the antenna cable is firmly and securely plugged into the Vehicle Dock. Make sure the cable is not bent or broken.• Turn the Radio Off, then On, to reset this message.• If the message persists, most likely the Magnetic Mount Antenna cable has been damaged. Replace the antenna.

If you see this on the screen:	Try this:
Channel Off Air	<ul style="list-style-type: none"> • The channel you've selected is not currently broadcasting. Tune to another channel.
Loading	<ul style="list-style-type: none"> • Your Radio is acquiring audio or program information. This message usually goes away in a few seconds.
Updating	<ul style="list-style-type: none"> • Your Radio is updating with the latest encryption code. Wait until the update is done. • You may be trying to tune to a channel that is blocked or unavailable. Tune to another channel.
–	<ul style="list-style-type: none"> • No program information, such as artist name, song title, or channel exists.
If this happens:	Try this:
You do not receive all the channels to which you subscribed	<ul style="list-style-type: none"> • Ensure that you have subscribed to the service by following the steps in the User Guide which accompanied your Radio. • Go to www.xmradio.ca/refresh and follow the directions refresh your Radio. • Call 1-888-438-9677 for further assistance.
Audio sounds too soft	<ul style="list-style-type: none"> • Raise the volume of your stereo system or increase the audio level of your Radio until the sound quality improves. Refer to the User Guide which accompanied your Radio for instructions.

Troubleshooting

If this happens:	Try this:
No audio when using the Aux In Cable or Cassette Adapter	<ul style="list-style-type: none">• Check all cables between your Radio and your vehicle's stereo system for a firm and secure connection.• Ensure you have selected the proper input source on your vehicle's stereo system.• Ensure that the FM Transmitter in the Radio is turned Off, and increase the audio level of the Radio. Refer to the User Guide which accompanied your Radio for instructions.
Audio fades or has static when listening	<ul style="list-style-type: none">• Check all cables for a firm and secure connection.• If you are using <i>PowerConnect</i> to listen via your vehicle's FM radio, and the problem persists, it most likely is interference from another commercial or broadcast FM station. You will need to find an unused or available FM channel in your area. Refer to step 4 on page 43.• If you are using <i>PowerConnect</i>, and you cannot solve the audio problem, try connecting the audio using the Aux In Cable or a Cassette Adapter. (Refer to page 39 and page 41.) If you cannot use those solutions, consider using an FM Direct Adapter. (Refer to page 44.)
No audio when using <i>PowerConnect</i> or FM DA	<ul style="list-style-type: none">• Check that your Radio and your vehicle's FM radio are tuned to the same FM channel.• Check that the FM transmitter in your Radio is On. Refer to the User Guide which accompanied your Radio for instructions.

If this happens:	Try this:
No song title or artist name is displayed	<ul style="list-style-type: none"> • The information may not be available or updates may be in progress.
Traffic and Weather channels sound different from other channels	<ul style="list-style-type: none"> • These channels use a different audio technology than other channels so they often sound different from other channels.
The Radio shuts off unexpectedly	<ul style="list-style-type: none"> • If your Radio has these features, check these: • If Delayed Power or Automatic Power is On, the Radio will turn off after the selected length of time in the dock. Set Delayed Power or Automatic Power to Off.
The demo is playing	<ul style="list-style-type: none"> • Your Magnetic Mount Antenna is not connected or you are not receiving the signal. Check that the antenna is connected properly and is not obstructed. • Refer to the User Guide which accompanied your Radio and disable Demo Mode.

Product Specifications

Product Specifications

System

Power Requirements:	9-16 V DC, 500 mA (max)
Operating Temperature:	-4°F to +140°F (-20°C to +60°C)
Audio Output:	1.0 Vrms (max)

Vehicle Dock

Dimensions:	4.0 in (width) x 2.3 in (height) x 1.2 in (depth) 102 mm (width) x 59 mm (height) x 31 mm (depth)
Weight:	1.6 oz (46 g)
Audio Connector:	1/8 in (3.5 mm) female
Antenna Connector:	SMB male

PowerConnect Power Adapter

Dimensions:	3.7 in (width) x 1.7 in (height) x 1.3 in (depth) 94 mm (width) x 43 mm (height) x 34 mm (depth)
Weight:	2.4 oz (69 g)
Input / Output:	9-16 V DC / 5 V DC, 1.5 A
Cable Length:	4 ft 7 in (1.4 m)

Vehicle Antenna

Type:	XM Magnetic Mount
Connector:	SMB female, right angle
Cable Length:	23 ft (7.0 m)

Aux In Cable

Connectors:	1/8 in (3.5 mm) stereo male to 1/8 in (3.5 mm) stereo male
Cable Length:	4 ft (1.2 m)

Patent and Environmental Information

Patent Information

It is prohibited to, and you agree that you will not, copy, decompile, disassemble, reverse engineer, hack, manipulate, or otherwise access and/or make available any technology incorporated in this product. Furthermore, the AMBE[®] voice compression software included in this product is protected by intellectual property rights including patent rights, copyrights, and trade secrets of Digital Voice Systems, Inc. The software is licensed solely for use within this product. The music, talk, news, entertainment, data, and other content on the Services are protected by copyright and other intellectual property laws and all ownership rights remain with the respective content and data service providers. You are prohibited from any export of the content and/or data (or derivative thereof) except in compliance with applicable export laws, rules and regulations. The user of this or any other software contained in a SiriusXM Radio is explicitly prohibited from attempting to copy, decompile, reverse engineer, hack, manipulate or disassemble the object code, or in any other way convert the object code into human-readable form.

Environmental Information

Follow local guidelines for waste disposal when discarding packaging and electronic appliances.

IC Statement

Operation is subject to the following two conditions: (1) this device may not cause interference, and (2) this device must accept any interference, including interference that may cause undesired operation of the device. For product available in the Canada market, only channel 1~11 can be operated. Selection of other channels is not possible. This device and its antenna(s) must not be co-located or operation in conjunction with any other antenna or transmitter. To reduce potential radio interference to other users, the antenna type and its gain should be so chosen that the equivalent isotropically radiated power (e.i.r.p) is not more than that permitted for successful communication. IC Radiation Exposure Statement: This equipment complies with IC RSS-102 radiation exposure limits set forth for an uncontrolled environment. This equipment should be installed and operated with minimum distance 20cm between the radiator & your body.

WARNING! The FCC and FAA have not certified this Satellite Radio Receiver for use in any aircraft (neither portable nor permanent installation). Therefore, SiriusXM cannot support this type of application or installation.

Copyrights and Trademarks

© 2012 Sirius XM Canada Inc. "SiriusXM", the SiriusXM logo, channel names and logos are trademarks of Sirius XM Radio Inc. and are used under license. "NFL" and the NFL Shield design are trademarks of the National Football League. NASCAR® is a registered trademark of the National Association for Stock Car Auto Racing, Inc. The NBA and NBA member team identifications are the intellectual property of NBA Properties, Inc. and the respective NBA member teams. © 2012 NBA Properties, Inc. All rights reserved. NHL and the NHL Shield are registered trademarks of the National Hockey League. © NHL 2012. Elvis Radio logo © EPE Reg. U.S. Pat & TM off. CFL® is a registered trademark of the Canadian Football League. All other trademarks, service marks, images and logos are property of their respective owners and are used with permission. All Rights Reserved. Required subscription sold separately. Pricing and programming is subject to change. Premier subscription required for some channels. See Customer Agreement for complete terms at www.siriusxm.ca.

www.siriusxm.ca

**Sirius XM Canada Inc.
135 Liberty St. - 4th floor
Toronto, Ontario, M6K 1A7**

1-877-438-9677

© 2012 Sirius XM Canada Inc.

XDPIV1UG 120906a